



AQ-SPEC

Air Quality Sensor Performance Evaluation Center

Mobile Platform Evaluation of Low-Cost Air Quality Sensors

Mobile Platform Setup and Testing Protocol

Jason Low, Ph.D.

Assistant Deputy Executive Officer

Vasileios Papapostolou, Sc.D.

Program Supervisor, AQ-SPEC

Berj Der Boghossian, M.Sc.

Air Quality Specialist

Ashley Collier-Oxandale, Ph.D.

Air Quality Specialist

Andrea Polidori, Ph.D.

Advanced Monitoring
Technologies Manager

Wilton Mui, Ph.D.

Air Quality Specialist

Steven Boddeker, M.Sc.

Air Quality Specialist



November 2020

TABLE OF CONTENTS

1)	EXECUTIVE SUMMARY.....	1
2)	ACKNOWLEDGMENTS.....	2
1	BACKGROUND.....	1
1.1	“LOW-COST” AIR QUALITY SENSORS	1
1.2	AIR QUALITY SENSOR PERFORMANCE EVALUATION CENTER (AQ-SPEC)	1
1.3	SENSOR SELECTION CRITERIA	2
2	MOBILE PLATFORM	3
2.1	VEHICLE	3
2.2	ELECTRICAL SYSTEM	4
2.3	INSTRUMENTATION RACK	5
2.4	REFERENCE ANALYZERS	8
2.4.1	PARTICLE ANALYZERS	10
2.4.2	GAS ANALYZERS	11
2.4.3	SUPPORTING INSTRUMENTATION	11
2.5	REFERENCE ANALYZER DATA COLLECTION	12
2.6	DUCT SAMPLING SYSTEM	14
2.6.1	DUCT CONSTRUCTION	14
2.6.2	PARTICLE ANALYZERS	15
2.6.2.1	Line Material	15
2.6.2.2	Representative Sampling	15
2.6.2.3	Aerosol Conditioning	18
2.6.3	GAS ANALYZERS	19
2.6.3.1	Line Material	19
2.6.3.2	Representative Sampling	19
2.7	EXHAUST FLOWS	20
2.8	WINDOW PASS-THROUGH PANELS	20
2.9	LOW-COST SENSOR INSTALLATION	21
2.10	LOW-COST SENSOR DATA COLLECTION	23
3	TEST PROCEDURES.....	24
3.1	SAFETY	26
3.2	TEST ROUTE DESIGN	27
3.3	EVALUATION ROUTES	28
3.4	NAVIGATION	33
3.5	REFERENCE ANALYZER PREPARATION	34
3.5.1	CALIBRATION AND ZERO-SPAN CHECKS	34
3.5.2	LEAK CHECK	34
3.5.3	PARTICLE INSTRUMENT CORRECTION FACTOR	34
3.5.4	CO-LOCATIONS	35
3.5.5	DELAY TIME	35
3.5.5.1	Signal Fall Time Measurement	35
3.5.5.2	Time Delay Cross-Correlation	36
3.6	PRE-TEST STEPS	37
3.7	LOW-COST SENSOR EVALUATION PHASES	39
3.7.1	PHASE 1 – ON-ROAD CONTROLLED FLOW VELOCITY SAMPLING	39
3.7.2	PHASE 2 – ON-ROAD PARTIALLY UNCONTROLLED FLOW VELOCITY SAMPLING	41
3.7.2.1	Preliminary Subphase	43

3.7.2.2	Clustered Subphase	43
3.7.3	PHASE 3 – ON-ROAD UNCONTROLLED FLOW VELOCITY SAMPLING	46
3.8	POST-TEST STEPS	48
3.8.1.1	Laboratory	48
3.8.1.2	Instruments	48
3.8.1.3	Data Download	49
3.8.1.4	Data Purge	49
3.8.1.5	Database Backup	50
4	<u>DATA TREATMENT.....</u>	<u>51</u>
4.1	QUALITY CONTROL	51
4.1.1	LIMITS OF DETECTION	51
4.1.2	NEAR-STATIONARY DATA	52
4.1.3	LOCAL VEHICLE TAILPIPE EMISSIONS	52
4.1.4	ANISOKINETICALLY-SAMPLED PARTICLE DATA	53
4.1.5	REFERENCE ANALYZER SAMPLE RELATIVE HUMIDITY	53
4.1.6	REFERENCE ANALYZER WARNINGS	53
4.2	DATA ADJUSTMENTS	53
4.3	POST-TEST DATA PREPARATION	53
4.4	EVALUATION PARAMETER CALCULATIONS	56
4.4.1	MEAN	56
4.4.2	ABSOLUTE AND RELATIVE STANDARD DEVIATIONS	56
4.4.3	MEAN BIAS, MEAN ABSOLUTE, AND ROOT MEAN SQUARE ERRORS	56
4.4.4	RANGE-BASED INTRA-MODEL VARIABILITY	58
4.4.5	DATA RECOVERY	58
4.4.6	LCS LAG TIME	58
4.4.7	LCS VS. REFERENCE R ² BY VELOCITY	58
4.4.8	PHASE 2 OPTIMAL LOCATION IN AN ENCLOSURE	60
5	<u>STUDY LIMITATIONS.....</u>	<u>61</u>
6	<u>REFERENCES.....</u>	<u>63</u>

1) Executive Summary

Commercially available low-cost air pollution sensors are increasingly prolific, multi-functional, connected, and inexpensive, making them an attractive alternative to reference-grade air monitors for consumers, educators, and academic researchers. Currently, low-cost sensors (LCS) are usually deployed in stationary monitoring applications. In contrast, their use in mobile deployments is relatively nascent, but is garnering interest from researchers and organizations as a logical extension of their affordable, compact, and low-power characteristics to acquire air quality data over larger geographic scales without significant capital investment.

However, the abundance of devices available on the market, inexpensive components used, and general lack of transparency regarding how the device converts a raw signal into a reported measurement can raise significant questions about data quality and reliability. To assist consumers and researchers in understanding these aspects of LCS, AQ-SPEC has established procedures for quantifying their performance in stationary applications in uncontrolled field conditions and controlled laboratory conditions.

AQ-SPEC is further advancing the field of air pollution sensor evaluation by creating a novel protocol for evaluating sensors in a mobile deployment scenario. A mobile platform has been developed, allowing for a suite of reference-grade air monitors to obtain samples from the ambient environment while in transit. LCS are 1) placed in an interior sampling duct, 2) installed in an exterior rooftop box, and then 3) simply mounted on the vehicle roof, in a series of testing phases that expose sensors to progressively uncontrolled conditions, representing reasonable use-cases by researchers and consumers. Measurements from LCS are compared against those collected by the reference analyzers to quantify performance metrics, such as data recovery, correlation to reference measurements, and variability between sensor units. The testing results can compare LCS performance in one use-case scenario against another and can even suggest sensor-specific mounting positions or orientations that result in improved correlation with the reference analyzers.

This protocol is the first attempt by any organization to establish a standardized method for evaluation of low-cost air pollution sensors in a mobile deployment scenario. In addition to providing valuable performance data of sensors for consumers and researchers, this document will serve as a guide for other organizations in evaluating LCS performance in a mobile application.

2) Acknowledgments

The pursuit and development of a mobile air pollution sensor testing protocol was foremost made possible by the support and encouragement of South Coast AQMD Executive Management, notably Wayne Nastri (Executive Officer) , Jill Whynot (Chief Operations Officer), and Matt Miyasato (Deputy Executive Officer, Science & Technology Advancement). We express sincere gratitude to them for the opportunity to work on such an innovative and forward-looking project that will advance the field of air pollution monitoring with LCS. We would also like to acknowledge support from other South Coast AQMD staff in this endeavor, including Mike Hamdan, Dennis Lyttle, Richard Parent, and Carl Thompson.

Much appreciation is also extended to Karin Tuxen-Bettman (Google Program Manager) and Daniel Kruusmagi, James Wilson, Alexander Cooper, and Vicente Heredia (Google Technical Team) for supplying the vehicle and batteries to power equipment. We also thank the mobile platform driver, Casey Clarke, for his patience and dedication throughout this effort.

Finally, we thank the reviewers of this protocol, George Allen, Gayle Hagler, and Jorn Herner. Their feedback and suggestions have not only made this document clearer for readers, but also rigorous despite the infancy of mobile deployment and evaluation of LCS.

FINAL DRAFT**1 Background****1.1 “Low-Cost” Air Quality Sensors**

Manufacturers have recently begun marketing low-cost air quality sensors to measure air pollution; considering how fast the air monitoring sensor technology is evolving, it is likely that the availability of such sensors in terms of both type and numbers will continue to grow soon. These devices, provided they produce reliable data, can significantly augment and improve current ambient air monitoring capabilities that now predominantly rely on more sophisticated and expensive fixed-site federal-reference monitoring devices and methods. These devices can be deployed on a mobile platform to better characterize local levels of air contaminants or over a wider geographic area to identify spatial and temporal trends. Given their “low-cost”, these sensors are becoming an attractive means for local environmental groups and individuals to independently evaluate air quality. The mobile deployment approach will likely introduce a paradigm shift to supplement traditional air monitoring by air regulatory agencies with fleet-based monitoring using air monitoring sensors. Due to their “low-cost” and ease of use, such devices also have the potential of becoming highly effective tools for introducing and engaging students and community groups in air quality matters.

There are, however, no independent objective means by which these devices can be evaluated, and data from these monitors are usually accepted at face value with no opportunity to evaluate their accuracy and overall quality. In fact, preliminary tests performed in the U.S. and in Europe seem to suggest that many of the commercially available air monitoring sensors have poor to modest reliability, do not perform well in the field under ambient conditions, and do not typically correlate well with data obtained using “standard” measurement methods employed by regulatory agencies. These limitations can be magnified when deploying these sensors on a mobile platform, on which they would be subjected to rapidly fluctuating pollutant levels and wind speeds. Poor quality data obtained from unreliable sensors, especially that in conflict with data obtained from traditional and more sophisticated monitoring networks, may not only lead to confusion but may also jeopardize the successful evolution of this “low-cost” sensor technology. Therefore, there is an urgent need to better characterize the actual performance of air monitoring sensors as well as to educate the public and users about the potential and limitations of these devices.

1.2 Air Quality Sensor Performance Evaluation Center (AQ-SPEC)

To provide the public with much-needed information about the actual performance of commercially available “low-cost” sensors, the South Coast Air Quality Management District (South Coast AQMD) has established the Air Quality Sensor Performance Evaluation Center (AQ-SPEC) to perform thorough performance characterization of currently available sensors using stationary field-, laboratory-, and mobile platform-based testing. In the field, air quality sensors are operated side-by-side with Federal Reference Methods and Federal Equivalent Methods (FRM and FEM, respectively) that are routinely used to measure air pollutants concentrations for regulatory purposes (Appendix A). All sensors are evaluated in triplicate and for a period of two months in the field to provide better statistical information of overall performance [1, 2].

In the lab, a state-of-the-art characterization chamber with FRM/FEM analyzers is used to challenge the sensors with known concentrations of different particle and gaseous pollutants under controlled environmental conditions [3].

On the mobile platform, sensors are also compared against reference analyzers to evaluate sensor performance under rapidly changing pollutant concentrations while subjected to mechanical vibrations, different microclimates, and various field flow conditions. Sensor *models* that have performed well in

stationary field and/or lab evaluations are subsequently considered for testing on a mobile platform using new sensor *units*. The idea behind mobile platform evaluation is to retain certain elements of the field and lab evaluation approaches (e.g. triplicate testing, comparison to reference analyzers), for consistency, to assess sensor performance in a mobile measurement application.

This document describes the mobile platform testing procedures used by South Coast AQMD staff to evaluate the performance of commercially available “low-cost” air quality sensors under transient ambient conditions in the South Coast Air Basin (SCAB) and under varying degrees of turbulence control.

All data collected, documentation developed, and testing results obtained during field and laboratory evaluations are organized and posted online as part of the AQ-SPEC website (www.aqmd.gov/aq-spec) and made available for free to educate the public on the capabilities of commercially available air quality sensors and their potential applications. Sensor-related events and workshop information are also posted on this website. As the mobile platform evaluation program develops, a future assessment will be made regarding publishing the results from mobile evaluations.

1.3 Sensor Selection Criteria

Sensors are first evaluated in the field at one of South Coast AQMD’s fixed air monitoring stations for at least two months. Depending on the field evaluation results, sensors, which have shown acceptable performance (coefficient of determination $R^2 > 0.5$), are brought back to the laboratory for chamber testing. Depending on the overall testing results, new units of sensor models showing acceptable performance may be integrated into the mobile platform for mobile testing.

Sensors selected for field, lab, and mobile testing must meet at least the following criteria to be considered for evaluation:

- The sensor shall be commercially available;
- The sensor shall measure one or more of the National Ambient Air Quality Standards (NAAQS) criteria pollutants, air toxics, pollutants of concern and non-air toxics. Examples of the targeted gases and particles are carbon monoxide (CO), ozone (O₃), nitrogen oxides (NO_x), particulate matter (PM), volatile organic compounds (VOCs), hydrogen sulfide (H₂S), and methane (CH₄);
- The sensor shall have high sensitivity at ambient level and low concentrations;
- The sensor shall provide real- or near-real time measurements. To be considered for evaluation, a sensor must have the ability to either store data internally or log data to a computer via a supplied software or have a serial port output. Logging data to a cloud-based server is also acceptable. Sensors storing data in other ways might be accommodated, provided confirmation by AQ-SPEC team;
- The sensor shall have the capability of continuously running for at least two months, using AC or DC power; and
- The market cost of the sensor shall be less than \$2000. If a device presents as a multi-pollutant sensor box, then the cost per pollutant type (individual sensor) should be less than \$2000.

FINAL DRAFT**2 Mobile Platform**

Google has provided a Street View vehicle for the South Coast AQMD AQ-SPEC program to use for mobile evaluation of low-cost sensors (LCS). A mobile platform laboratory system, designed and integrated by AQ-SPEC staff, is installed inside the vehicle, and is hereafter referred to as the South Coast AQMD mobile platform (Figure 1).



Figure 1: Exterior views of the South Coast AQMD mobile platform.

The mobile platform laboratory system consists of the following major components:

- 2009 Hyundai Santa Fe vehicle (Google Street View car)
- Instrument power and electrical systems
- Instrumentation racks
- Suite of FRM/FEM¹ or Best Available Technology (BAT) reference analyzers
- Sampling duct and probes
- Window pass-through panels
- Reference analyzer data communication/collection system
- LCS installation zones
- LCS data communication/collection system

2.1 Vehicle

The mobile platform laboratory system is housed within a Google Street View 2009 Hyundai Santa Fe, measuring 184" L x 74" W x 68" H (4.7 m x 1.9 m x 1.7 m). The rear passenger row seating, along with the floor panels in both the rear row and trunk spaces, were removed to create space for the batteries and instrumentation racks. Housing was constructed around the batteries to provide protection and a level platform upon which AQ-SPEC was able to install instrumentation racks and equipment (Figure 2).

¹Reference analyzers with FRM/FEM designations from the US EPA are used strictly for research purposes in this work. On the mobile platform, these analyzers are used in a manner that is not consistent with FRM/FEM requirements, e.g. nonstationary sampling.



Figure 2: Protective framing in the mobile platform constructed over batteries and level platform for instrumentation.

2.2 Electrical System

All components of the mobile platform laboratory, except for the vehicle itself, are powered from a power system that is independent from the vehicle. This allows for the laboratory to operate whether the vehicle engine is running.

The Google Technical team developed the laboratory battery housing and battery placement to deliver the vehicle to AQ-SPEC with a power system setup that met Google's safety standards. Per AQ-SPEC's requests, the Google Technical team installed 5 absorbent glass mat (AGM) deep-cycle batteries with a total capacity of 500Ah. To house these batteries, modifications were necessary to adapt to the uneven trunk of the vehicle. The batteries were placed in an "X" layout and secured utilizing T-slotted framing (Figure 3). Adding a sixth battery would have required raising the center batteries due to the uneven trunk floor, and therefore interfered with the bars that secure the batteries down.



Figure 3: Arrangement of batteries in the mobile platform.

The laboratory power system consists of five pure lead AGM batteries, each rated at 12 VDC and 100 amp-hr, housed within the aluminum framing in the base of the trunk of the vehicle (Figure 3). The batteries are connected to a 2500 W inverter (AIMS Power PICOGLF25W12V120AL) capable of handling a 7500 W surge, with 100-120 VAC at 60 Hz output. The inverter is also integrated with a charging system capable of 85 A charging rates. Multi-outlet surge protectors are plugged into the inverter. All components in the mobile platform requiring electrical power, apart from those associated with the vehicle operation, are plugged into these surge protectors.

The laboratory battery bank charge capacity can power all components for over 8 hours. The batteries are recharged after each test drive via the charging capabilities of the inverter. The inverter is grounded to the vehicle frame. The analyzer racks are grounded to the inverter. All analyzers are grounded to the rack for safety. Therefore, all conductive particle sampling lines are also grounded to the vehicle rack.

2.3 Instrumentation Rack

Adjustable depth, 4-post, open frame steel server racks are used to house all reference analyzers. Three instrumentation racks are installed in the vehicle: one large rack mounted in the center of the vehicle behind the front row seats (hereafter referred to as the “PM rack” since it houses reference PM analyzers), and two smaller racks mounted adjacent to one another in the trunk of the vehicle (hereafter referred to as the “gas racks” since they house reference gas analyzers). All racks accommodate “standard” 19-inch wide components. The PM rack height accommodates 12 Rack Units (one Rack Unit is 1.75 inches) and the gas racks each accommodate 8 Rack Units. Figure 4 shows the PM rack adjusted to a depth of 40 inches (1 meter) to accommodate the PM reference analyzers, data logger, and inverter. Figure 5 shows the gas racks adjusted to a depth of 24 inches (0.6 meters) to accommodate the gas reference analyzers.



Figure 4: Adjustable depth steel server rack used to house reference PM analyzers ("PM rack").



Figure 5: Adjustable depth steel server racks used to house reference gas analyzers ("gas racks").

Most instruments are mounted to the instrumentation racks by direct securement to sliding rails, as seen in Figure 5. Instrumentation without integrated rail mounts are bolted down to a sliding rail shelf. The sliding rails are secured and locked into place by use of fixed lock plates attached to the rack posts. This

FINAL DRAFT

allows for the analyzers to be secure during on-road testing while also being modular for periodic maintenance, servicing, and repairs.

There are two vibration-dampening platforms in the vehicle; a lower platform in the rear passenger row for the PM rack and an upper platform in the trunk for the gas racks. As shown in Figure 6, each vibration-dampening platform consists of:

- Aluminum base framing secured to the chassis via the rear passenger seat and trunk bolts to create a level plane;
- Lower wood board;
- Vibration-dampening cable mounts;
- Upper wood board; and
- Top foam layer



Figure 6: Lower and upper vibration-dampening platforms.

FINAL DRAFT

The vibration-dampening cable mounts (Figure 7) insulate the instrumentation racks against engine vibrations and sudden accelerations in all directions, which could result from abrupt stops, tight turns, and bumpy road conditions. The number of vibration-dampening cable mounts and cable thickness was selected to support at least three times the weight of the rack(s) and reference analyzers. Finally, ratchet tie-downs are used to secure the upper corners of the racks to the vehicle frame with enough slack to permit platform sway during normal driving conditions, yet not too much slack to allow the platform to detach from the vehicle in a sudden stop (Figure 8).

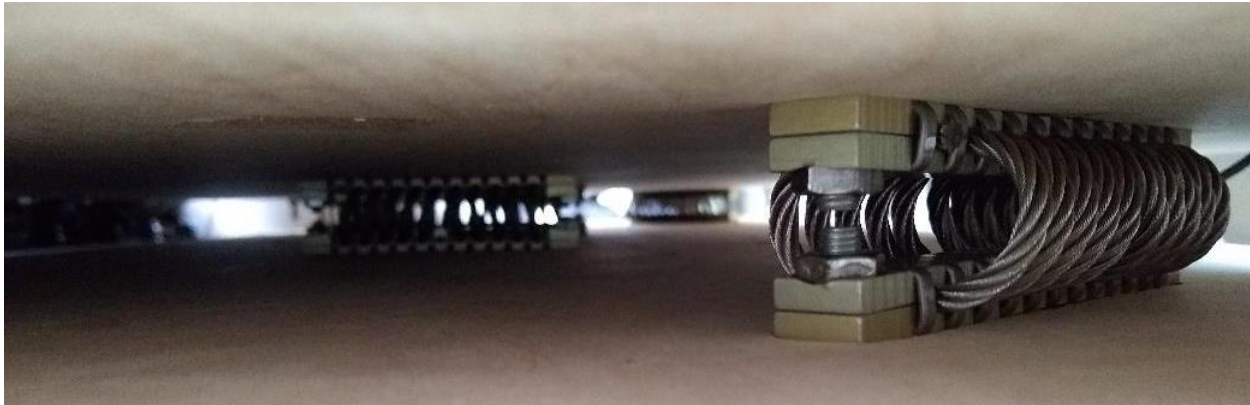

Figure 7: Vibration-dampening cable mounts between the lower and upper wood boards of the vibration-dampening platform.

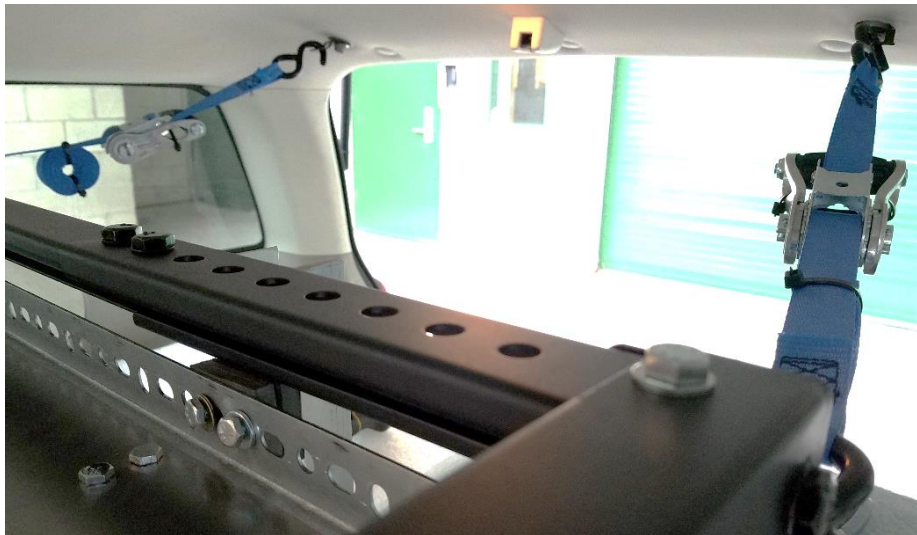

Figure 8: Ratchet tie-downs that prevent racks from detaching from vibration-dampening platform in a sudden stop event

2.4 Reference Analyzers

The mobile platform laboratory is equipped with a suite of seven regulatory/research-grade analyzers (see Appendix A) to measure gas-phase and particle-phase pollutants, as well as supporting measurements for temperature, relative humidity (RH), sampling duct flow velocity, and coordinate position. Table 1 summarizes the measurement equipment in the laboratory. A positional diagram of reference analyzers is shown in Figure 9. A pneumatic flow diagram for reference analyzers is shown in Figure 10.

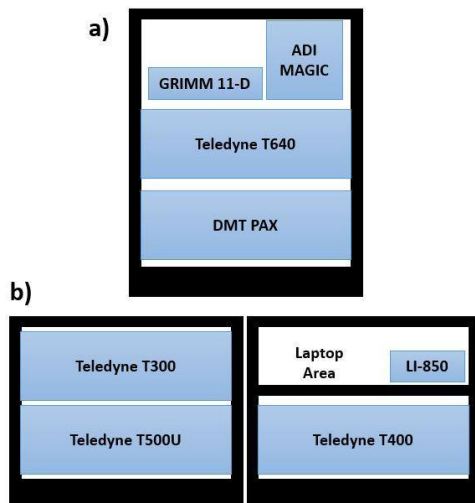

Figure 9: Positional diagram of reference analyzers integrated into the instrumentation racks: a) PM rack in rear passenger row with GRIMM 11-D, ADI MAGIC CPC, Teledyne T640, and DMT PAX; b) Gas racks in trunk with Teledyne T300, T500U, T400, and LI-850, along with an open shelf for a laptop computer for communications with the analyzers and data logger.

Table 1: Summary table of mobile platform equipment.

Manufacturer	Model	Parameter ²	Data Frequency	Designation ³
GRIMM Aerosol Technik	11-D	PM _{10/2.5/1.0}	6-sec	BAT
Teledyne API	T640	PM _{10/2.5}	3-sec	FEM (for PM _{2.5})
Teledyne API	T400	O ₃	3-sec	FEM
Teledyne API	T500U	NO ₂	3-sec	FEM
Teledyne API	T300	CO	3-sec	FRM
LI-COR	LI-850	CO ₂	1-sec	BAT
Aerosol Devices Inc. (ADI)	MAGIC Condensation Particle Counter (CPC)	Particle Count	1-sec	BAT
Droplet Measurement Technologies, Inc. (DMT)	Photoacoustic Extinctionmeter (PAX)	Black Carbon	1-sec	BAT
Extech Instruments	407119	Duct Flow Velocity	1-sec	---
Fisherbrand	Traceable Humidity Meter	Duct Flow T and RH	1-sec	---
GlobalSat	SiRF Star IV USB GPS Receiver (BU-353S4)	Position	1-sec	---

²Although reference analyzers may output a value for PM₁₀, further work is needed to improve the sampling system for PM₁₀. Currently, PM₁₀ is not a pollutant that will be evaluated on the mobile platform.

³Reference analyzers with FRM/FEM designations from the US EPA are used strictly for research purposes in this work. These analyzers are used in a manner that is not consistent with FRM/FEM requirements, e.g. nonstationary sampling. CO₂, particle count, and black carbon are parameters for which no FRM/FEM exists. BAT means Best Available Technology, indicating that the reference analyzer does not possess a regulatory performance designation, but the principle of operation and design of the reference analyzer provides among the highest accuracy and performance available on the market.

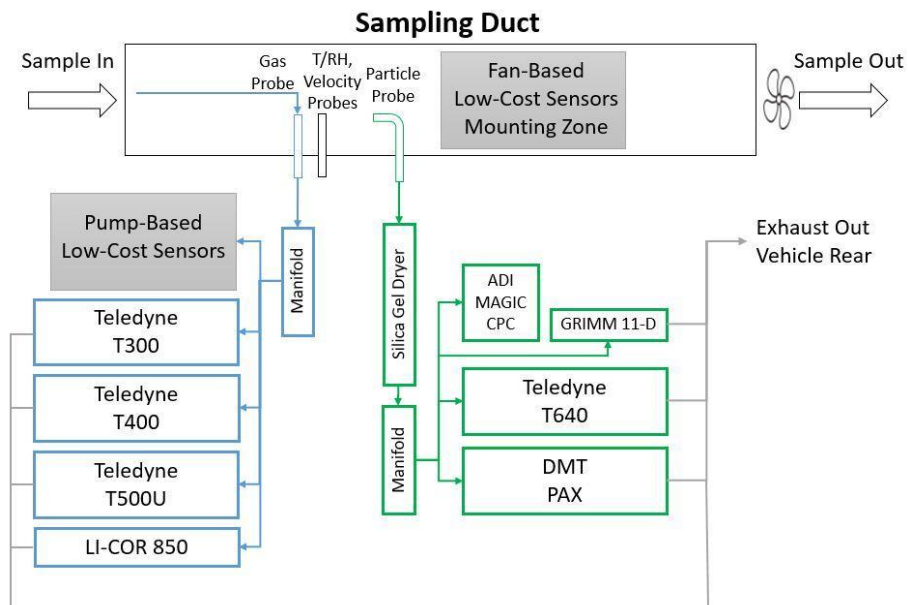

Figure 10: Pneumatic flow diagram of the mobile platform.

2.4.1 Particle Analyzers

The GRIMM 11-D spectrometer provides near-real-time measurements (more frequently than every 10 seconds) of $PM_{10/2.5/1.0}$. The measurements are based on single-particle laser light scattering to determine particle counts in 31 size channels from 0.253-35.15 μm . There is a $\pm 3\%$ uncertainty in the measurement from the sample flow rate regulation, according to the vendor.

The Teledyne T640 particulate analyzer provides near-real-time measurements of $PM_{10/2.5}$. The measurements are based on single-particle broadband light scattering to determine particle counts in 256 size channels from 0.18-20 μm . This instrument has a precision of $\pm 0.5 \mu g/m^3$, according to the vendor. This instrument is designated as US EPA $PM_{2.5}$ Federal Equivalent Method EQPM-0516-236 (see Appendix A).

It should be noted that although the GRIMM 11-D and Teledyne T640 analyzers output a value for PM_{10} , further work is needed to improve the sampling system for PM_{10} . Currently, PM_{10} is not a pollutant that will be evaluated on the mobile platform.

The ADI MAGIC CPC returns real-time measurements (every 1 second or faster) of ultrafine particle counts and employs a condensational growth system with a continuous water-wetted Durapore wick to enlarge ultrafine particles that are then optically detected. This instrument is unaffected by orientation or mechanical vibration. The working fluid (water) is stored in an exterior reservoir and the wick is wetted through transport of the water through a Nafion tube, eliminating the possibility of optics flooding.

The DMT PAX measures both particle light scattering and absorption to quantify real-time black carbon concentrations. The sample flow is split between a nephelometer (to measure scattering) and a photoacoustic cell (to measure absorption). A laser beam heats up absorbing particles, producing pressure waves that are detected in a microphone in the photoacoustic cell. The sum of the scattering

and absorption signals provides a total extinction measurement. This instrument performs automatic zeroing at regular intervals to minimize drift.

2.4.2 Gas Analyzers

The Teledyne T400 measures near-real-time O₃ concentrations using ultraviolet (UV) absorption with a mercury vapor lamp directed through alternating volumes of sample and ozone-free scrubbed gas. The uncertainty in the measurement is ±10% from the sample flow rate and 0.5% from noise, according to the manufacturer. The Teledyne T400 is designated as a US EPA O₃ Federal Equivalent Method EQOA-0992-087 (see Appendix A).

The Teledyne T500U measures near-real-time NO₂ concentrations using cavity attenuated phase shift spectroscopy. UV light is transmitted into a sample gas-filled cell with mirrors on both ends to create an extensive path length. A photodiode detector receives the light, and the relative change in light frequency (rather than intensity) is used to determine the NO₂ concentration. The uncertainty in the measurement is ±10% from the sample flow rate and 0.2% + 20 ppt from noise; the precision is 0.5%; and the lower detectable limit is 40 ppt, according to the manufacturer. The Teledyne 430 is designated as a US EPA NO₂ Federal Equivalent Method EQNA-0514-212 (see Appendix A).

The Teledyne T300 measures near-real-time CO concentrations using infrared (IR) light transmitted through a multi-pass cell containing the sample gas. A photodetector measures the light intensity remaining at the end of the cell, which is converted to a CO concentration. To correct for water vapor interference, a reference gas cell is incorporated into the IR light path. The uncertainty in the measurement is ±10% from the sample flow rate and 0.5% from noise; the precision is 0.5%; and the lower detectable limit is 0.04 ppm, according to the manufacturer. The Teledyne 300 is designated as a US EPA CO Federal Reference Method RFCA-1093-093 (see Appendix A).

The LI-COR 850 measures real-time CO₂ concentrations using IR light absorption through a gold-plated optical path. This analyzer also accounts for the interfering effect of water vapor by making simultaneous H₂O concentration measurements to provide a more accurate CO₂ concentration. This instrument has an accuracy of ±1.5%; an uncertainty from noise of <1 ppm; and a lower limit of detection of 1.5 ppm, according to the manufacturer.

2.4.3 Supporting Instrumentation

The Extech Instruments 407119 hot wire anemometer measures the real-time velocity in the sampling duct to screen for turbulent flow conditions. The instrument can measure air velocity up to 17 m/s with a 0.1 m/s resolution and ±5% of reading (+ 0.5 m/s) accuracy.

The Fisherbrand Traceable Humidity Meter monitors the near-real-time temperature and RH in the sampling duct to provide ambient meteorological parameters important for post-analysis of the data collected. The temperature range is -18 to +93°C, with 0.1°C resolution and accuracy of ±1°C in the ambient range. The RH range is 10 to 95% with 0.1% resolution and ±2% accuracy at mid-range and ±4% accuracy near the ends of the range. The response time is <10 seconds. This meter is NIST-traceable and calibrated by an ISO 17025 laboratory.

The GlobalSat SiRF Star IV BU-353S4 is a GPS receiver with a horizontal positioning accuracy of less than 2.5 m.

FINAL DRAFT**2.5 Reference Analyzer Data Collection**

The data collection for the reference analyzers, instruments, and equipment is performed by an Agilaire 8872 data logger over serial/RS-232 and Modbus connections. Instruments with data collected via serial/RS-232 ports include the GRIMM 11-D, ADI MAGIC CPC, DMT PAX, Extech duct anemometer, Fisherbrand temperature and humidity meter, and GlobalSat SiRF Star GPS Receiver. Instruments with data collected via Modbus connection include the Teledyne T640, Teledyne T500U, Teledyne T400, and Teledyne T300 analyzers.

Data collection for the serial protocol and Ethernet via virtual serial occurs at a rate of once per second, except for the GRIMM 11-D. Data collection for the GRIMM 11-D occurs at a rate of once per 6 seconds since that is the highest reporting frequency for that instrument. Data collection for instruments connected via Modbus occurs at a rate of once per 3 seconds. Coupled with the data logger is an on-board monitor which provides access to the 8872 while viewing data in real-time during on-road monitoring. Additionally, a Red Lion BT-6721 cellular modem is also installed to allow for remote access capabilities to monitor real-time data of the on-road sampling from a headquarters. Table 2 summarizes the instrument data communications properties.

Table 2: Summary of instrument data communications properties

Instrument	Parameter ⁴	Connection Type	Data Frequency	Baud Rate	Data Bits	Parity	Stop Bits	Flow Control
GRIMM 11-D	PM _{10/2.5/1.0}	Serial	6-sec	19200	8	None	1	None
Teledyne T640	PM _{10/2.5}	Modbus	3-sec	—	—	—	—	—
Teledyne T400	O ₃	Modbus	3-sec	—	—	—	—	—
Teledyne T500U	NO ₂	Modbus	3-sec	—	—	—	—	—
Teledyne T300	CO	Modbus	3-sec	—	—	—	—	—
LI-COR LI-850	CO ₂	Serial	1-sec	9600	8	None	1	None
ADI MAGIC	Particle Count	Serial	1-sec	115200	8	None	1	None
DMT PAX	Black Carbon	Serial	1-sec	115200	8	None	1	None
Extech 407119	Duct Flow Velocity	Serial	1-sec	9600	8	None	1	None
Fisherbrand Traceable Humidity Meter	Duct Temperature and RH	Serial	1-sec	1200	7	None	1	None
GlobalSat SiRF Star GPS Receiver	GPS	Serial	1-sec	9600	8	None	1	None

⁴Although reference analyzers may output a value for PM₁₀, further work is needed to improve the sampling system for PM₁₀. Currently, PM₁₀ is not a pollutant that will be evaluated on the mobile platform.

FINAL DRAFT

2.6 Duct Sampling System

A transverse sampling duct was constructed for reference analyzers and LCS to sample from under controlled, non-turbulent flow conditions. The principle design basis for the transverse sampling duct is as follows: under the condition of zero flow from the inline duct fan, the pressure at both ends of the transverse sampling duct are equal since the duct is perpendicular to the vehicle direction of travel. Assuming no wind field external to the vehicle, this equilibrium pressure condition holds true regardless of the vehicle velocity. Following this reasoning, the inline duct fan can then be run to induce a constant pressure differential, and therefore constant air flow rate, across the sampling duct regardless of the vehicle speed.

This sampling duct flow rate immunity to vehicle speed does not hold in a non-transverse sampling duct configuration (e.g. a longitudinal sampling duct, or a forward-facing sampling duct inlet). In these configurations, the flow velocity inside the duct, and therefore sensor response, would be influenced to a great degree by the dynamic pressure at the sampling duct inlet caused by the vehicle velocity.

2.6.1 Duct Construction

To minimize electrostatically-induced particle losses, the sampling duct is constructed of galvanized steel duct segments. The segment of duct inside the vehicle cabin is 48 inches (1.22 m) in length with a square cross-section measuring 8 inches (0.2 m) per side, resulting in a volume of 1.77 ft³ (0.05 m³). A square cross-section sampling duct was chosen for ease of mounting sampling probes and LCS (with fan-based sampling) inside the duct. Both ends of the main duct segment transition to 11-inch (0.28 m) long, 4-inch (0.1 m) diameter round duct ends that protrude out opposite sides of the vehicle. The duct ends terminate with round aluminum weather caps adjusted to slip onto a 4-inch (0.1 m) diameter duct (Versa 3050 Type B Gas Vent). The weather caps have four 7-inch (0.18 m) diameter louvers to prevent rain from entering the sampling duct as well as break up turbulent eddies that could propagate into the sampling duct and affect flow turbulence. Due to vehicle modification constraints, the sampling duct inlet is located at a height of 54 inches (1.4 m) above the ground. Figure 11 shows the assembled sampling duct before integration into the mobile platform.

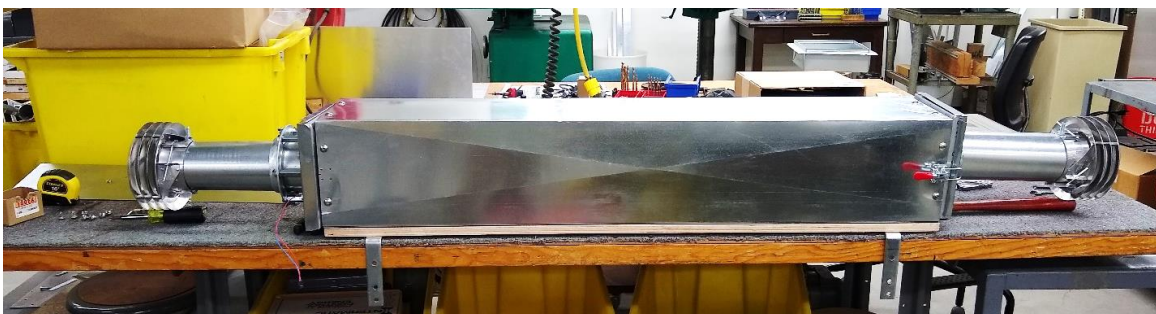

Figure 11: Assembled transverse sampling duct.

An inline axial fan capable of providing up to 7 ft³/min (0.003 m³/s) of air flow is installed on the port-side end of the duct, just outside the main sampling duct segment and concentric with the round termination segment protruding out the window. The voltage supplied to the fan can be controlled to adjust the flow rate induced by the fan and verify non-turbulent flow conditions using measurements from the duct velocity probe. The inline fan is oriented such that outside air is pulled into the sampling duct from the starboard (passenger) side of the vehicle and exhausted through the port (driver) side of the vehicle. This flow direction was chosen since the mobile platform will usually drive in the rightmost lane on a multilane

FINAL DRAFT

roadway; sampling from the starboard side of the vehicle also reduces the chances of localized influence from vehicle tailpipe emissions. Figure 12 shows the interior of the sampling duct with the inline fan.

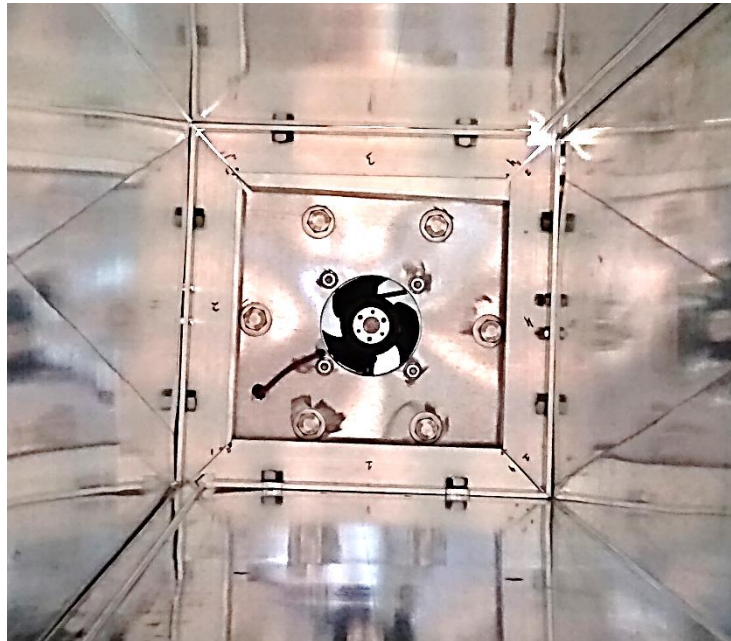

Figure 12: Interior view of the sampling duct inline fan

2.6.2 Particle Analyzers

2.6.2.1 *Line Material*

Particles are susceptible to losses from parasitic electric fields that result from static charge buildup on ungrounded and dielectric materials. To minimize electrostatic particle loss, the particle sampling probe is constructed from aluminum and stainless steel, and all tubing and fittings connecting the probe to particle reference analyzers are made of conductive material (stainless steel, aluminum, or conductive silicone tubing). Tubing from any exhaust ports of particle reference analyzers can be of any material since particle losses after the point of detection are not important. Furthermore, the entire conductive sampling line and the particle reference analyzer must be electrically grounded to the vehicle frame to eliminate voltage potential buildup.

2.6.2.2 *Representative Sampling*

To obtain a representative particle sample on a mobile platform, the following conditions should be met [4, 5, 6]:

- Isoaxial sampling;
- Isokinetic sampling;
- Minimization of turbulent losses;
- Minimization of gravitational losses;
- Minimization of inertial losses;
- Minimization of electrostatic losses; and
- Minimization of diffusional losses.

Isoaxial sampling must be satisfied to ensure that flow streamlines into the particle sampling probe are not bent and thus supermicron particles are accurately represented in the acquired sample. If the probe

is anisoxial, the flow streamlines into the sampling probe are bent and supermicron particles will generally be underrepresented in the acquired sample. The reference analyzer particle sampling probe inlet is a pipe elbow with a 90° bend, oriented to be isoaxial with the centerline of the duct flow and positioned near the midpoint of the sampling duct.

Isokinetic sampling requires that flow streamlines are not biased into or away from the probe inlet. If the sampling velocity is anisokinetic, the flow streamlines are also bent and supermicron particles in the sample will not be representative of the ambient air. If the sampling velocity is less than the duct flow velocity, flow streamlines will be biased away from the probe inlet, leading to oversampling of supermicron particles; conversely, if the sampling velocity is greater than the duct flow velocity, flow streamlines will be biased into the probe inlet, leading to undersampling of supermicron particles. Isokinetic sampling on a mobile platform is achieved through designing the sampling probe so that the probe inlet cross-sectional area and the sample flow rate result in an air sampling velocity at the probe inlet that matches the duct flow velocity. The total sample flow rate of all particle analyzers combined is 7.5 lpm (0.000125 m³/s). To match a non-turbulent duct velocity of 0.15 m/s, the particle sample probe inlet diameter is 0.0326 m. The mobile platform isokinetic sampling probe is shown in Figure 14c.

Note that isokinetic probe design is a technically advanced topic – simply calculating the probe inlet diameter such that the sampling velocity will match a given outside flow velocity is the bare minimum requirement. There are additional considerations to minimize particle losses once they enter the probe. Furthermore, an isokinetic sampling probe will only be isokinetic at a certain flow velocity; if the flow velocity in the duct varies due to poor fan speed control or excessive outside wind, some of the particle sampling performed during a test could be anisokinetic.

Turbulence deposits particles onto walls, as well as re-suspends deposited particles; both mechanisms lead to measurement error. Achieving non-turbulent flow in the sampling duct generally requires transporting ambient air through the duct such that the Reynolds number, Re , does not exceed 4000. The Reynolds number is a dimensionless quantity represented by the ratio of the inertial forces to viscous forces within a fluid, and the condition for non-turbulence is expressed in Equation 1:

$$Re = \frac{\rho UL}{\mu} < 4000 \quad (1)$$

where ρ is the fluid density, U is the fluid velocity, L is a characteristic length dimension (in this case, the hydraulic diameter of the square duct), and μ is the fluid dynamic viscosity. To achieve $Re < 4000$, the duct axial fan is operated to provide a nominal flow velocity of 0.15 m/s in the sampling duct. The flow velocity is monitored by a velocity probe mounted inside the sampling duct (Figure 14b), with the probe tip positioned at the flow centerline. The flow velocity results in a duct flow rate and residence time of approximately 371 lpm (0.0062 m³/s) and 8.1 seconds, respectively. Turbulent losses in sampling lines are avoided by using sampling line diameters large enough for the flow rate through the line such that $Re < 4000$.

Gravitational particles losses occur when particles are transported upward or horizontally. Gravitational losses impact supermicron particles more than submicron particles, especially as the time spent traveling upward or horizontally increases.

Inertial losses are those due to deviations of particles from bending flow streamlines, and therefore supermicron particles are particularly impacted due to their inability to rapidly adapt to changing flow conditions. Inertial losses will mainly result from bends in the sampling probes and lines. Sampling lines

are kept as straight as possible with sweeping bend radii if necessary. In the case of the sampling probe, the 90° bend is unavoidable to transport particles from the duct flow centerline into the vehicle cabin. The minimization of inertial losses in the sampling probe is achieved by ensuring that the probe bend radius is at least 10 times the stopping distance for the largest expected particles. For the largest particle diameter included in measurements by the GRIMM 11-D of 35.15 μm , the stopping distance is 0.57 mm; the bend radius of the sampling probe far exceeds 10 times the stopping distance, or 5.7 mm.

Electrostatic particle losses can occur in sampling lines because charges can accumulate on dielectric materials, resulting in localized parasitic electric fields. Electrostatic losses impact submicron particles more than supermicron particles. To eliminate electrostatic particle losses all probes, fittings, manifolds, and sampling lines consist of conductive materials, such as stainless steel, aluminum, or conductive flexible silicone tubing.

Diffusional losses result from random Brownian motion transporting particles toward walls. This phenomenon has a larger impact on submicron particles, with the most pronounced effect on ultrafine particles. This loss mechanism is minimized by reducing particle transport time as much as possible, mainly through the avoidance of excess tubing length and diameter.

Tools used to estimate anisoaxial, anisokinetic, turbulent, gravitational and inertial particle losses from the sampling probe include Aerocalc [7] and the Particle Loss Calculator [8] tools. Figure 13 shows the modeled particle efficiencies at different vehicle velocities, accounting for sampling effects, diffusion, sedimentation, turbulent inertial deposition, and inertial deposition due to bends and contractions through the sampling duct and PM probe combined using the Particle Loss Calculator tool. Even at freeway vehicle speeds, 2.5 μm particles can be sampled at up to ~70% efficiency, while 10 μm particles cannot be sampled at over 10% efficiency when traveling faster than ~5 mph. These results suggest that further work is needed to improve the sampling system for PM_{10} , and therefore PM_{10} is not currently a pollutant that will be evaluated on the mobile platform. Note that only a portion of the 0 mph velocity scenario returned values based on parameter inputs that are within the range of applicability for equations used to model efficiencies; results for all other velocities are likely overestimates of efficiency. Particle aspiration and penetration efficiencies for the sampling duct and the PM probe are in Appendix B.

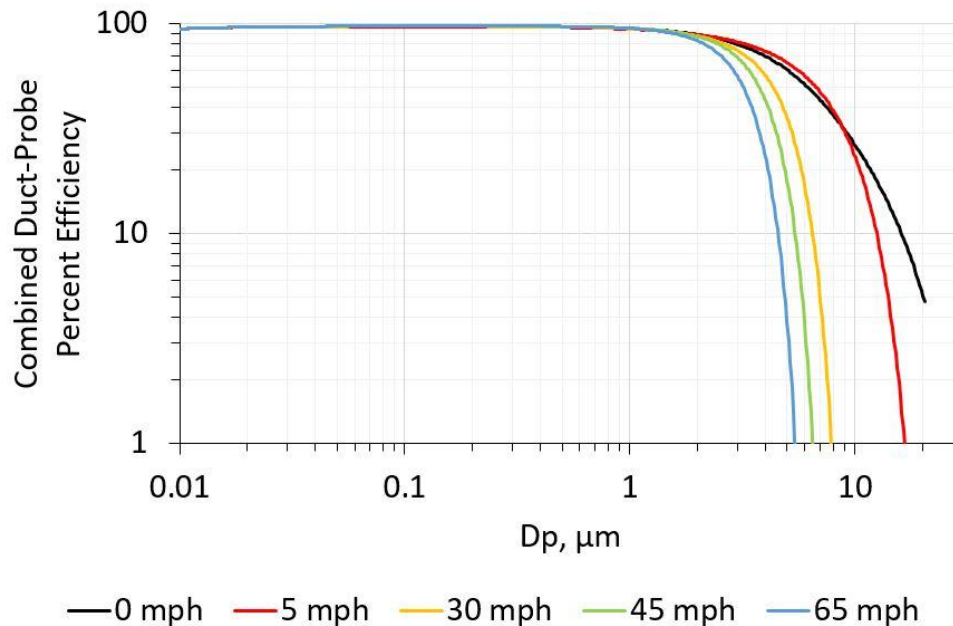

Figure 13: Modeled particle total efficiency (product of aspiration and penetration efficiencies) for particles through the combined sampling duct and PM probe at different vehicle velocities. Results obtained using the Particle Loss Calculator tool [8]. Note that only a portion of the 0 mph velocity scenario returned values based on parameter inputs that are within the range of applicability for equations used to model efficiencies; results for all other velocities are likely overestimates of efficiency.

2.6.2.3 *Aerosol Conditioning*

Particle samples need to be conditioned (dried), especially if sampling from humid air or air that is much warmer than the vehicle cabin air (the vehicle air conditioning system is run in recirculation mode and maintained at 21-24°C with slight variation due to the heat load from the outside temperature). Humid particle samples have two negative effects on particle analyzers. First, humid particle samples may have enough water vapor pressure to condense water onto particles and enlarge particle diameters, which will result in an overestimation of particle mass and particle size distribution parameters. Second, excess water vapor in the sample can condense onto sampling lines and internal instrument components, causing instrument damage or erroneous measurements.

Aerosol conditioning can be achieved through several means, including heating, desiccation, dilution, or membrane water exchange. Heating tubes decrease the RH of an air sample and can vaporize water from particles. However, there are three drawbacks of using heating tubes for aerosol drying, which are 1) risk of vaporizing volatile organic particle components, 2) moisture recondensation in instrument lines if they are at a lower temperature, and 3) high power consumption. Desiccation involves flowing sample through a volume packed with hygroscopic material (such as silica gel) to remove water vapor from the air via diffusion, with the drawback being high maintenance costs involved in monitoring and changing out the hygroscopic material. Dilution involves simply adding dry air to the sample to decrease the humidity, at the expense of the signal-to-noise ratio. Membrane water exchange employs polymers that are selectively and highly permeable to water (such as Nafion), with dry air flowing on one side of the membrane and humid sample air on the other side; the water vapor differential results in a transfer of water from the sample air. For both dilution and membrane exchange, a source of dry air and additional power to move the dry air must be provided.

FINAL DRAFT

In the mobile platform, a silica gel drying tube is used to condition the sample for all particle analyzers. The silica gel employs water vapor-indicating color changes to alert users when the silica gel's water absorptive capacity has declined and needs to be replaced with regenerated silica gel. The silica gel typically needs to be replaced every 10-15 test drives, or 2-3 weeks of daily testing.

2.6.3 Gas Analyzers

2.6.3.1 *Line Material*

Probe and sampling line material used for transporting air samples to gas reference analyzers should be as chemically inert as possible. An ideal material would be fused silica-coated stainless steel (e.g. Silonite), but stainless steel, glass, perfluoroalkoxy (PFA), and polytetrafluoroethylene (PTFE; "Teflon") are also reasonably chemically inert. In the mobile platform, air samples for gas reference analyzers are transported from the steel sample duct inlet through a PTFE line and probe, followed by a stainless-steel manifold, with PTFE tubing leading to the analyzer inlets. Tubing from exhaust ports of gas reference analyzers can be of any material since gas reactivity after the point of detection is not important.

2.6.3.2 *Representative Sampling*

Since gas molecules readily adapt to changing flow streamlines, isokinetic (and for that matter, isoaxial) sampling is not necessary. Of greater concern for representative sampling is minimizing reaction losses of the gas species of interest, which is achieved primarily through minimizing sample transport time and sampling line material reactivity. In practice, this means using stainless steel or PTFE sampling line material and eliminating unnecessary sampling line length, as well as thorough cleaning of probes, manifolds, and sampling lines with isopropanol, and then conditioning with high concentrations of O₃ if necessary. The reference gas analyzers obtain sample through PTFE tubing from a stainless-steel manifold; the manifold is fed by a 3/8" PTFE pipe segment inserted into the steel sample duct; the pipe segment is connected to a 3/8" PTFE tubing segment that extends to the inlet of the sampling duct. The gas sampling probe is shown in Figure 14a. The PTFE tubing segment that allows the gas analyzers to sample as close as possible to the sampling duct inlet is shown in Figure 15.

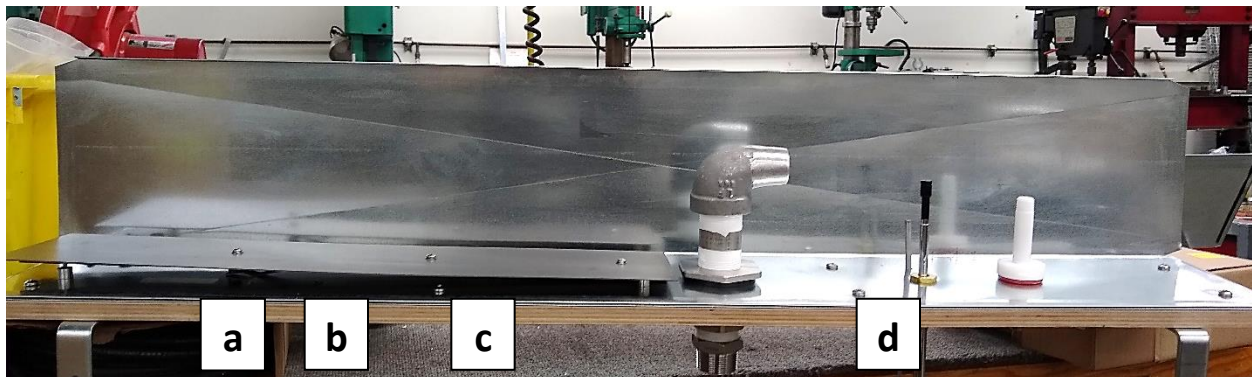

Figure 14: Key components inside the sampling duct, from left to right: a) PTFE sampling probe for reference gas analyzers, b) temperature/RH and flow velocity probes, c) isokinetic sampling probe for reference PM analyzers, and d) LCS mounting platform on sliding rail for units with fan-based sampling.



Figure 15: PTFE line connected to PTFE pipe segment for gas analyzer sampling. This line allows for acquisition of gas sample as close as possible to the sample duct inlet to minimize gas contact and reaction with sampling duct surfaces.

2.7 Exhaust Flows

All reference analyzers are connected to a common exhaust line that is vented through the starboard side rear window. This exhaust line is directed toward the rear of the vehicle and is of sufficient length to reach the rear end of the vehicle, minimizing the possibility of analyzer exhaust being resampled into the duct, especially when the vehicle is traveling forward.

2.8 Window Pass-Through Panels

The reference analyzers and LCS are housed inside the vehicle. To obtain outside ambient air samples, ducting is passed across the width of the vehicle and through the vehicle's rear windows. This sampling design choice was selected to address the safety concerns posed by Google about having multiple, sharp-edged sampling probes protruding from the vehicle (risk of equipment damage, pedestrian strikes, and interference in Street View imagery). To reduce cabin noise, maintain a constant interior temperature, and minimize pollutant exposure to the driver, window pass-through panels for the sampling duct are installed into the window openings. The window pass-through panels are constructed of clear Plexiglas to allow for visibility of the reference analyzer displays from the outside and to maximize visibility for the driver (Figure 16).

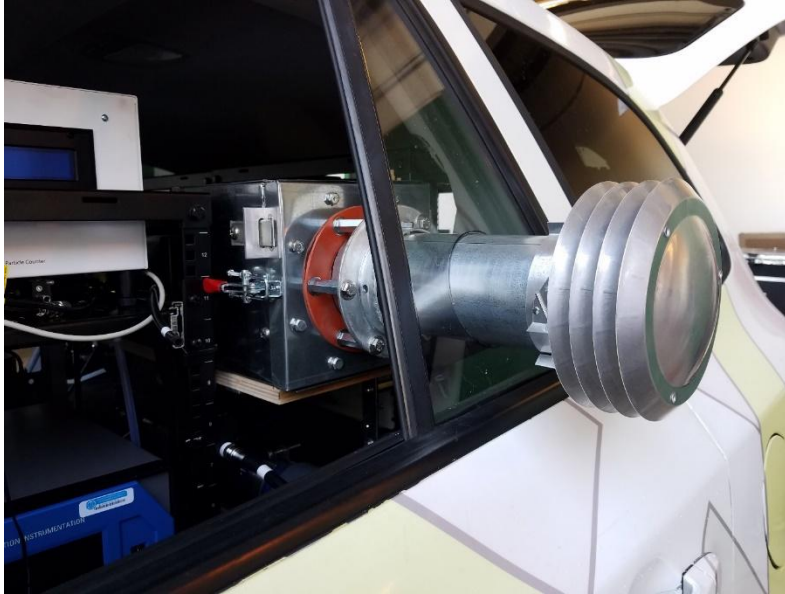

Figure 16: Clear Plexiglas window passthrough with sampling duct.

2.9 Low-Cost Sensor Installation

LCS often have the following characteristics that make obtaining high-quality data a challenge in a mobile application:

- Fan-based sampling: For cost and noise reduction, some LCS employ fans to transport sample toward a sensor. Consequently, fan-based LCS may not be able to control the incoming air flow rate to the design flow rate when the unit is subjected to turbulent winds, resulting in erroneous readings.
- Lack of sampling port: In contrast to reference analyzers, some LCS do not have a clearly-defined sampling port with which to connect gas fittings and tubing. As a result, such units need to be wholly surrounded by the sample air.
- Sensitivity to temperature and RH: LCS response can be sensitive to the sample temperature and RH. On a moving platform, this problem is aggravated by the potential for rapidly changing sun exposure, temperature, and RH conditions as the vehicle enters different microclimates (e.g. inland to coast, crossing over a mountain range into a different valley, etc.).

LCS are evaluated in the mobile platform in three phases, in order of decreasing degree of control of environmental conditions:

- 1) Sampling from a controlled flow environment;
- 2) Sampling from a sheltered, but uncontrolled flow environment; and
- 3) Sampling from an unsheltered, uncontrolled flow environment.

In the first case, LCS are installed such that they sample from the controlled flow transverse duct. If an LCS has a pump-based sampling mechanism and the LCS inlet can connect to gas fittings, then the LCS will sample from either the gas or PM manifold (depending on what the LCS measures), and the LCS would be secured to the instrument racks. Otherwise, the LCS are installed in the transverse duct on the sliding tray downstream of the reference analyzer sampling probes, such that they are wholly enveloped in the ambient sample. If LCS are small enough, they are mounted radially around the duct flow centerline; otherwise, they are mounted in series along the duct flow path. In any case, LCS are installed such that

FINAL DRAFT

their sample inlets are perpendicular to the duct flow path. Further details on LCS installation in the controlled flow environment are in Section 3.7.1.

In the second case, LCS are installed inside of a polyethylene tote box, with adjustable openings to change the path of ambient air through the box as the vehicle moves, which is mounted on the vehicle rooftop (Figure 17). While the box shelters the LCS from direct sun exposure and rain, only partial protection from high-velocity wind is provided. LCS are installed such that their sample inlets are perpendicular to the ambient air flow path in the box. An initial investigation mounts LCS in different positions in the box to determine the installation location that results in best correlation of LCS data with reference analyzer observations, for each air flow path. LCS are then installed in a cluster in the determined optimal location for a given air flow path for evaluation. Further details on LCS installation in the sheltered but uncontrolled flow environment are in Section 3.7.2.

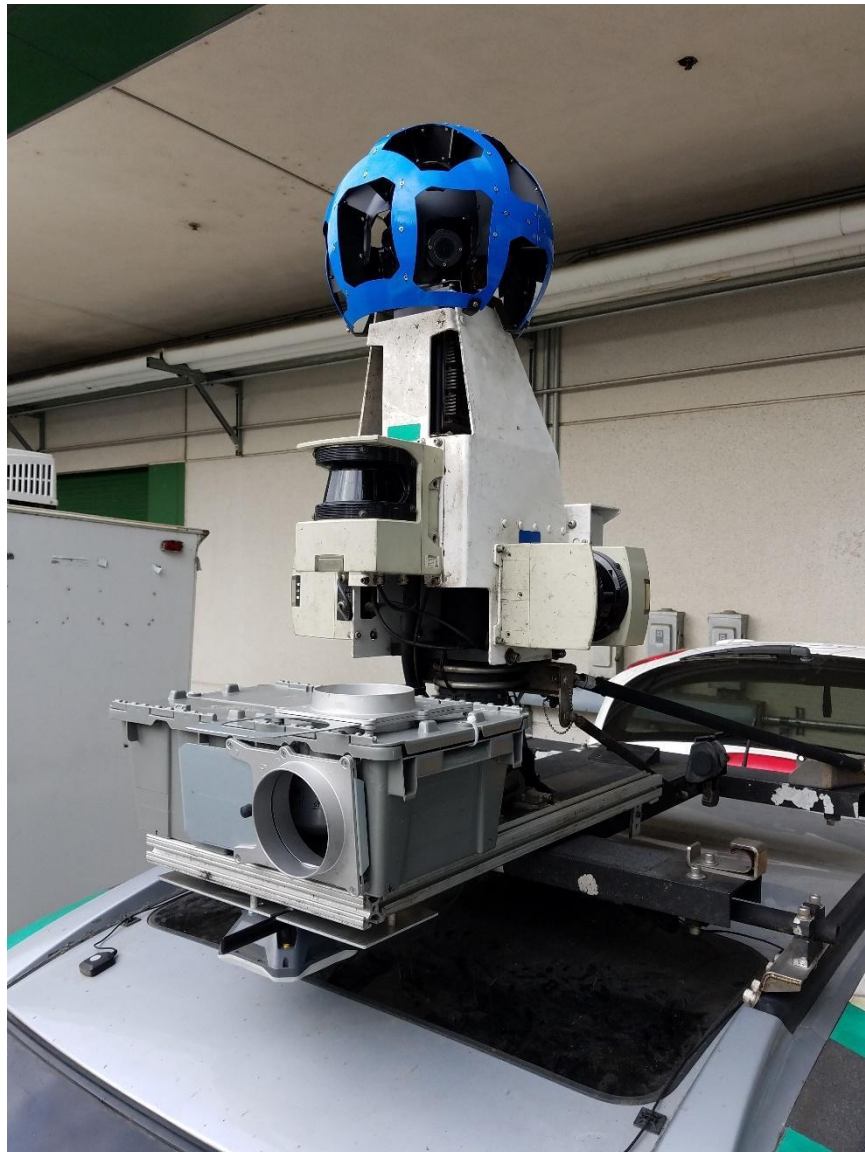

Figure 17: Mobile platform rooftop enclosure box for evaluation LCS under partially-controlled conditions. This method represents a simplified approach to mobile monitoring.

FINAL DRAFT

In the third case, LCS are installed directly on the vehicle rooftop, with no protection from sun, rain, or wind. If an LCS is not weatherproofed, or the vendor states the LCS is only for indoor use, they will not be tested on days when rain is expected. The Google Technical team developed a T-slotted framing on the rooftop of the vehicle in front of the Street View camera that was not within the frame of view of their imagery system (Figure 18). LCS are evaluated in three different orientations in this phase: a) with the LCS oriented in the “default” position that is specified or suggested by vendor marketing materials or user manuals, b) with the LCS inlet facing forward relative to the direction of travel, and c) with the LCS inlet facing backward relative to the direction of travel. Further details on LCS installation in the unsheltered, uncontrolled flow environment are in Section 3.7.3.



Figure 18: Mobile platform rooftop framing allowing for mounting of additional equipment and LCS.

2.10 Low-Cost Sensor Data Collection

LCS vendors design their products such that there is a wide variety of how data can be retrieved from the sensors. For LCS that require Bluetooth or wired connections (e.g. Ethernet, USB, or serial cables), the sensors are connected to a laptop inside the vehicle with the necessary software required to log the data. Many other LCS require an internet connection to transmit data to a cloud-based server, from which data can be later downloaded. An Alcatel Linkzone 7537 mobile hotspot in the mobile platform allows for LCS internet access for data transmission.

FINAL DRAFT**3 Test Procedures**

Mobile platform testing procedures are conducted in three phases that evaluate LCS under a range of controlled and uncontrolled mobile deployment conditions. A high-level summary of the testing procedure is shown in Figure 19.

The first phase subjects the sensors to mobile sampling *in controlled, constant non-turbulent flow conditions*; this removal of wind speed influence allows for any difference in readings between sensors and reference analyzers to be due only to mechanical vibration and signal smearing from sensor delay time. For LCS that transmit data to a cloud-based server, this first phase also tests the ability of the sensor to reliably send data via the internet while in movement (mobile data recovery).

The second phase subjects sensors to mobile sampling *in partially uncontrolled flow conditions* and involves installing the units inside of a polyethylene enclosure box attached to the roof of the mobile platform, with partial exposure to fluctuations in wind speeds while the vehicle is in transit. This allows for determination of sensor performance degradation due to subjecting the sensor to a turbulent flow environment from a partially sheltered/protected mobile deployment scenario.

The third phase also subjects sensors to mobile sampling *in completely uncontrolled flow conditions* and involves installing the units on the roof of the mobile platform, completely exposed to the outside environment and fluctuations in wind speeds while the vehicle is in transit. This allows for determination of sensor performance degradation due to subjecting the sensor to a turbulent flow environment from an unsheltered/unprotected mobile deployment scenario.

To avoid any bias effects due to sensor aging from the field and/or laboratory evaluations, new and unused sensor units are used for the mobile platform evaluation. Intentional testing of the sensors in different temperature and RH conditions on the mobile platform is not conducted, since it would be impractical to attempt to control these factors. Furthermore, these efforts would only duplicate the climate susceptibility evaluation that sensors would have previously undergone in the AQ-SPEC laboratory evaluation [9], while not revealing anything about sensor performance that is *specific* to mobile deployment.

FINAL DRAFT

Mobile Platform Evaluation of Low-Cost Air Quality Sensors

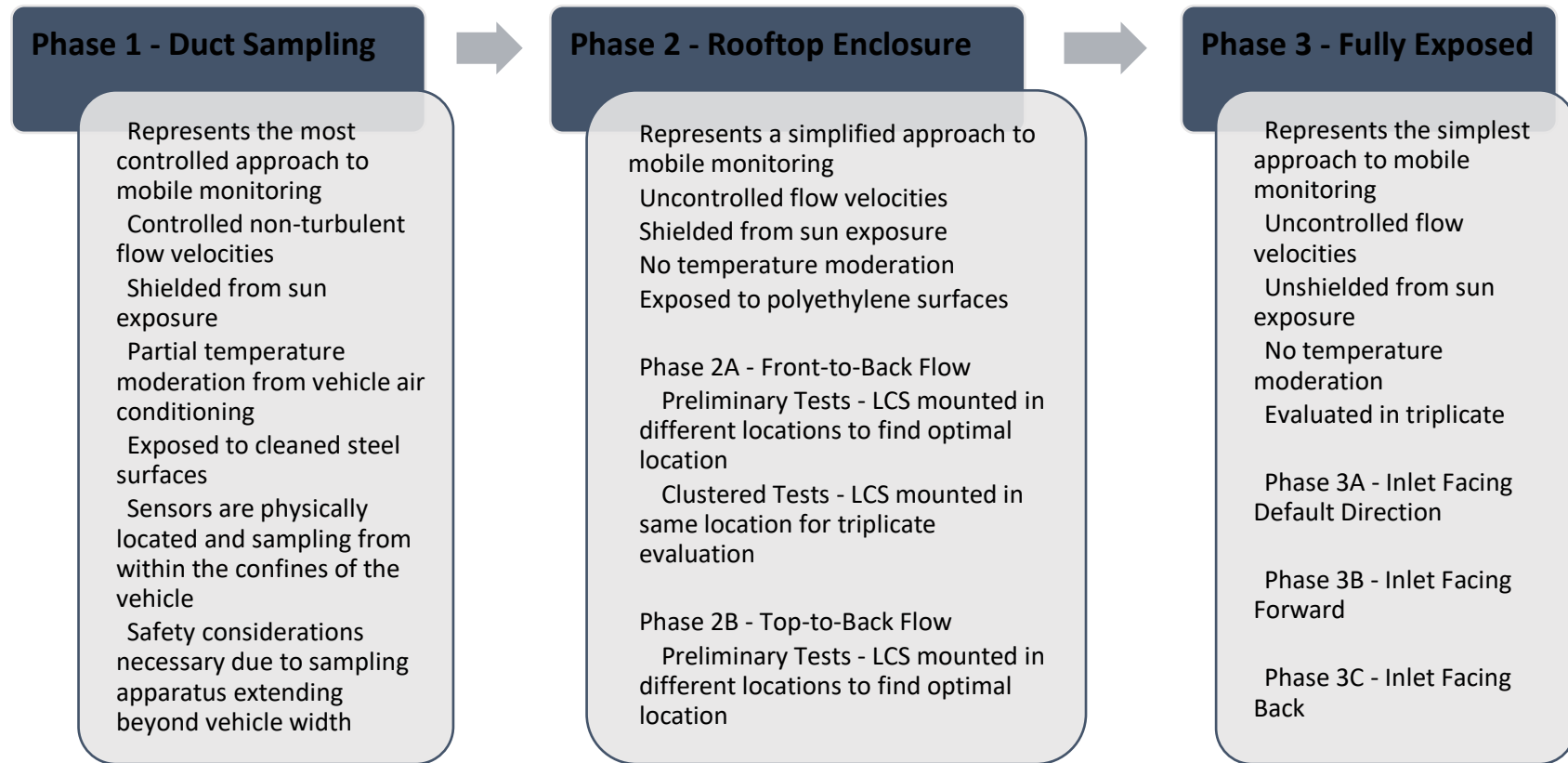

Figure 19: Mobile platform LCS evaluation phase summary.

3.1 Safety

Safety is the top priority while operating the mobile platform.

The following precautions were taken during development of the mobile platform:

- Not modifying or tampering any safety features of the vehicle itself;
- Leaving the driver and front passenger seating areas as off-limits to instrumentation;
- Bolting the instrumentation racks to the vibration-dampening platforms, which are secured to the vehicle chassis;
- Anchoring the instrumentation racks to the vehicle frame with ratchet tie-downs to restrict rack movement during a sudden stop;
- Using a flow duct design that does not interfere with the front and side views from the driver's perspective;
- Using a flow duct design that does not block the driver or front passenger from exiting the vehicle in an emergency;
- Allowing for a clear rear-view sight for the driver by limiting instrumentation rack height;
- Providing electrical power to all instrumentation and equipment through a power system separate and independent from the vehicle;
- Providing adequate clearance between the instrumentation rack and vehicle laboratory power system batteries;
- Placing the laboratory power system batteries on vibration-dampening pads, covering the battery terminals with heat shrink tubing and specialized tape, and securing the batteries to the chassis via insulated cross beams to avoid movement during driving;
- Electrically grounding all instrumentation and equipment to the vehicle frame;
- Restricting rooftop components to a maximum height of 14 feet above ground during on-road tests to clear overpasses; and
- Restricting rooftop components to a maximum height of 8 feet above ground when driving in parking garage structures.

The following precautions are taken by staff involved in operating the mobile platform:

- Distracted driving is prohibited; the driver must be solely focused on driving;
- Observations can be noted by the driver when safely pulled over or parked, such as prior to a break;
- Always obey laws, street signs, and speed limits;
- Use defensive driving techniques to safely conduct tests (e.g. maintain safe distances from vehicles, avoid unnecessary lane changes);
- Avoid sudden maneuvers to protect humans and instruments;
- Do not drive into areas with a clearance height lower than the height of the vehicle with the Google Street View mounted camera system;
- Perform vehicle checks periodically (tire pressure, tire degradation, fluid levels);
- Do not leave the vehicle parked or charge the laboratory power system in an uncovered area during rain events; and
- Vent the vehicle cabin during battery recharging to prevent H₂S accumulation.

3.2 Test Route Design

Many factors must be considered when designing a test route. The routes must be designed with spatiotemporal variations in mind to provide data in areas of focus or concern, as well as the time of day the sampling will be performed within that area.

Areas of interest will depend on the goal of the test route. For example, if a test route is being designed to include a detailed screening/sweep within a specific community, then the route must be designed to gather a concentrated amount of data collection within the community's boundaries. However, the test route does not have to be composed of just the area of interest as adding other regions within the same route can provide for a desired variation of pollutants and concentrations, providing data with a range of varying values. The drive to and from the area of focus should be included as sectors of the test route.

Test routes can oftentimes become confusing and lengthy. To ease the workload on the driver as well as maximize efficiency, a few key things must be kept in mind when designing a new route:

- Routes should run along major roads and highways (unless driving onto small/backroads is imperative for the goal of the test). This effectively would add certainty that even though unforeseen setbacks can occur, such as road construction, at least to one open lane is likely to remain;
- Intersections are a key component to an efficient route. When designing routes, running the vehicle through intersections with traffic lights is key. Avoid guiding a driver through intersections that hold the vehicle at stop signs and forces the driver to find an opening on a busy street to turn into. Oftentimes, such an intersection can be stressful and dangerous for a driver and can set the test schedule back by minutes at a time. Additionally, attempt to design routes that typically make right turns at traffic light intersections, as left turns can open possibilities of being stuck at a traffic light for many cycles;
- Dividing the route into designated sectors can help produce more categorized data results. For example, if a route runs from South Coast AQMD headquarters to an area of interest (like a specific community), then around the adjacent county (on freeways), then back to South Coast AQMD headquarters, having multiple sectors could be helpful in displaying the analyzed results. One sector can be the drive from South Coast AQMD headquarters to a specific community, another sector can be the data collected while driving through the community itself, a third sector can be the data collected during the drive through an adjacent county, and a fourth sector can be the drive back to South Coast AQMD headquarters. This can effectively help present categorized data that can hone in on areas of interest while excluding less desired data;
- Time of day is important to consider. While designing a route, be mindful of the estimated time a driver will reach/drive through a given area. Consider the typical traffic in that location at that time of day, or day of the week. Heavy traffic can set back the testing schedule;
- Do not design routes that will run outside of the South Coast AQMD jurisdiction area without approval of upper management;
- Driver breaks and meals are important to consider. Design routes that allow for plenty of options for a driver to stop the vehicle and take a break or meal. Breaks and meals must be taken at locations which allow for safe parking of the mobile platform vehicle, provide the driver with a restroom option, and allow for direct line-of-sight between the driver and the vehicle to ensure safety. Again, design routes with time of day in mind so that the driver will be in an area with plenty of options during a time range in which a meal will be taken;
- Feedback from a driver should be solicited to improve the test routes. Of course, designing a route on a computer can hide more detailed issues that arise in real-world driving. Such issues can

include not enough distance to merge safely and make a turn, or too many left turns at intersections that are forcing the driver to stop at many intersection traffic lights.

Test routes should be open to adaptation and modification. Improvements should always be sought after. The guidelines listed above are starting points, however a combination of driver feedback and changes in test route goals (spatiotemporal data types) must also be considered and implemented. An example of a test route is shown in Figure 20.

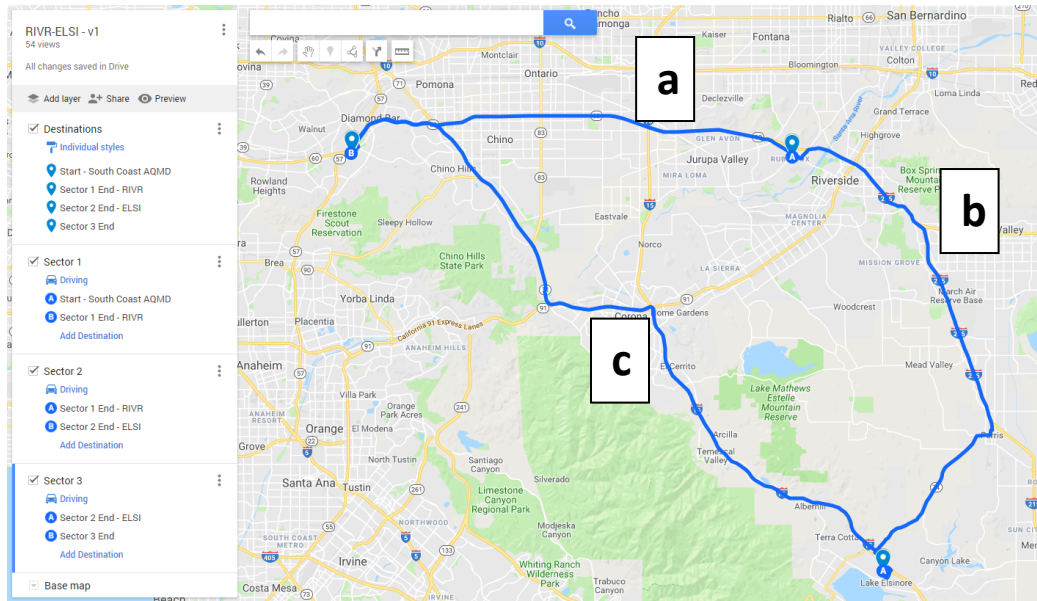

Figure 20: An example test route designed to include two co-location stops at two South Coast AQMD Air Monitoring Stations. The route is divided into three sectors: a) one to the RIVR station, b) one to the ELSI station, and c) one back to South Coast AQMD headquarters

Each route is designed with specific goals in mind, be it driving through a community or passing by known sources of emissions (like a refinery). Due to this, a driver must follow the route exactly with minimal to no deviations. This is also the primary reason a “polygons” concept would not work for such a focused drive (the “polygons” concept is when an area is highlighted with boundaries and the driving within the boundaries is generalized without any specified route). On the road, a driver cannot be distracted by searching for directions or improvising/driving in a general direction. Turn-by-turn navigation is critical for a driver to utilize to minimize distractions, maximize safety, and ensure specific areas of interest are sampled from.

Designing test routes requires utilization of Google My Maps (<https://www.google.com/mymaps>), a feature that allows for creating extended driving routes and export of the information in a keyhole markup language (KML) or zipped keyhole markup (KMZ) format. The export file is utilized, after conversion to a GPS exchange (GPX) file, in a third-party app to display the turn-by-turn navigation during test routes. The proper setup and configuration of turn-by-turn navigation is explored in the following section.

3.3 Evaluation Routes

During a test, the driver is to safely operate the vehicle and navigate through predetermined routes. The driver is to take notes of interest prior to and after driving, and during breaks. A copy of the Test Log Forms is in Appendix C.

Several possible test routes were evaluated in the summer of 2019 and observed pollutant concentrations are summarized in Table 3.

Table 3: Observed pollutant concentration ranges on piloted test routes.

Route Name	Route Geographic Focus	PM _{2.5} Range* (µg/m ³)	PM ₁₀ Range* (µg/m ³)	O ₃ Range* (ppbv)	NO ₂ Range* (ppbv)
DTLA	Downtown Los Angeles	5-15	8-25	2-60	10-70
LA-SFV	Central Los Angeles and San Fernando Valley	5-30	5-50	1-70	10-60
LB	Long Beach	5-15	5-30	1-60	5-60
PCH	Pacific Coast Highway and Orange County	3-15	5-25	15-50	3-40
IE-SGV	Inland Empire and San Gabriel Valley	3-30	5-50	1-70	5-60
RC-PS-Crest	Riverside County, Palm Springs, and Crestline	3-20	5-40	1-100	1-80

*Expected approximate concentration ranges based on drives conducted in summer 2019; tests conducted in a different season or year may report significantly different pollutant concentrations.

The IE-SGV test route was selected as being the optimal route for PM/O₃/NO₂ concentration ranges and ability to complete the test route within working hours. This route reliably provides a large range of several on-road pollutant concentrations (Figure 21).

In addition, a Co-location route was selected for checking mobile platform reference analyzer readings against stationary air monitoring station (AMS) observations. This route co-locates the vehicle at the RIVR (Riverside-Rubidoux) and ELSI (Lake Elsinore) AMS. The two AMS locations generally possess different air pollutant profiles and are equipped with PM₁₀, PM_{2.5}, O₃, NO₂, and CO analyzers.

Figure 22 and Figure 23 show the IE-SGV and Co-location routes, respectively. Other routes may be created and tested that also provide different ranges of pollutant values. For certain pollutants, such as CO or black carbon, special routes may be created in the future to expose LCS to concentrations much greater than those typically found in ambient air, e.g. tunnels, parking garages, near wildfires, or following diesel trucks.

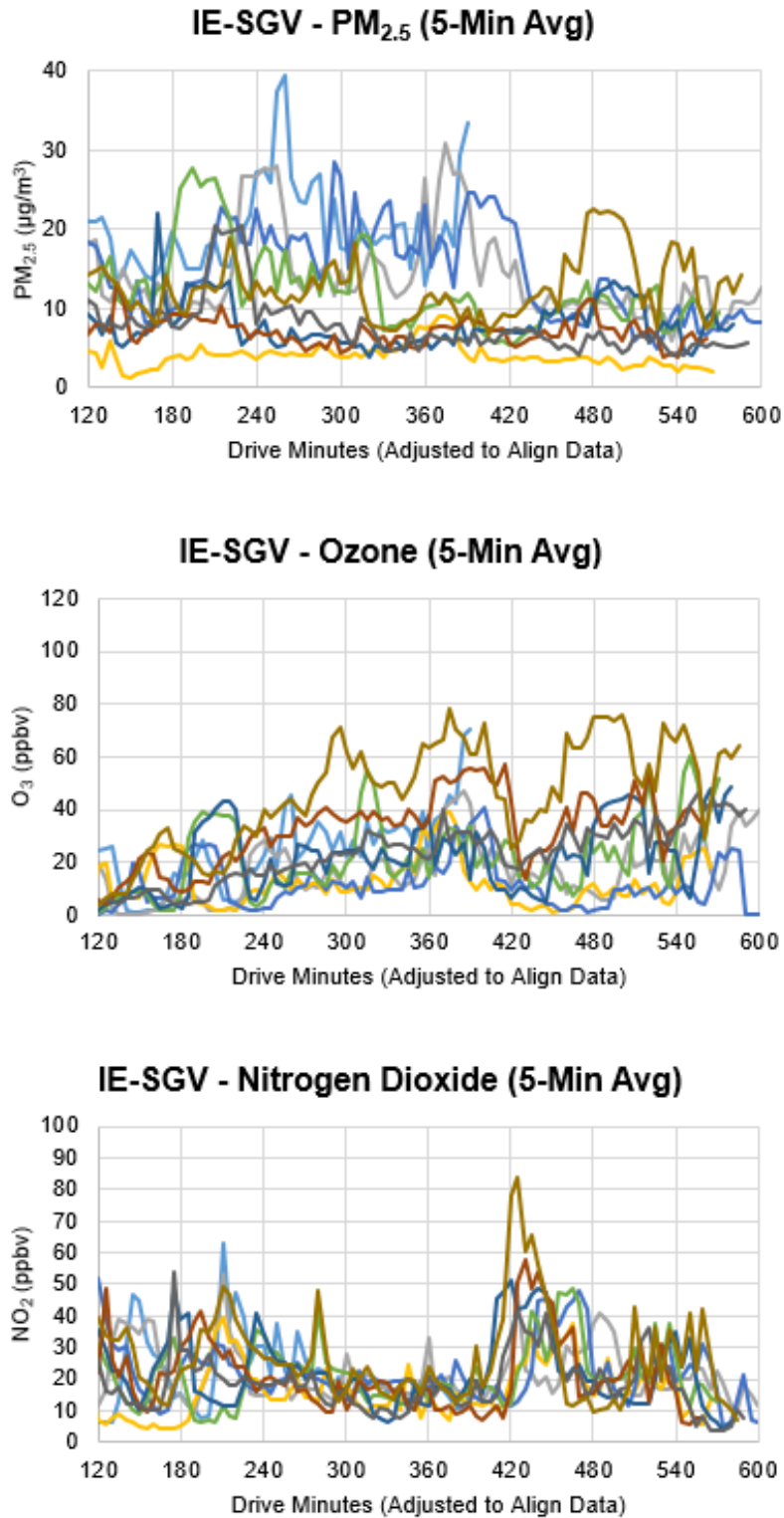

Figure 21: Representative pollutant profiles obtained from the IE-SGV route. Data obtained from various drives conducted in the months of June through August 2019. Concentrations of pollutants observed on a route can be significantly different from those shown in this figure.

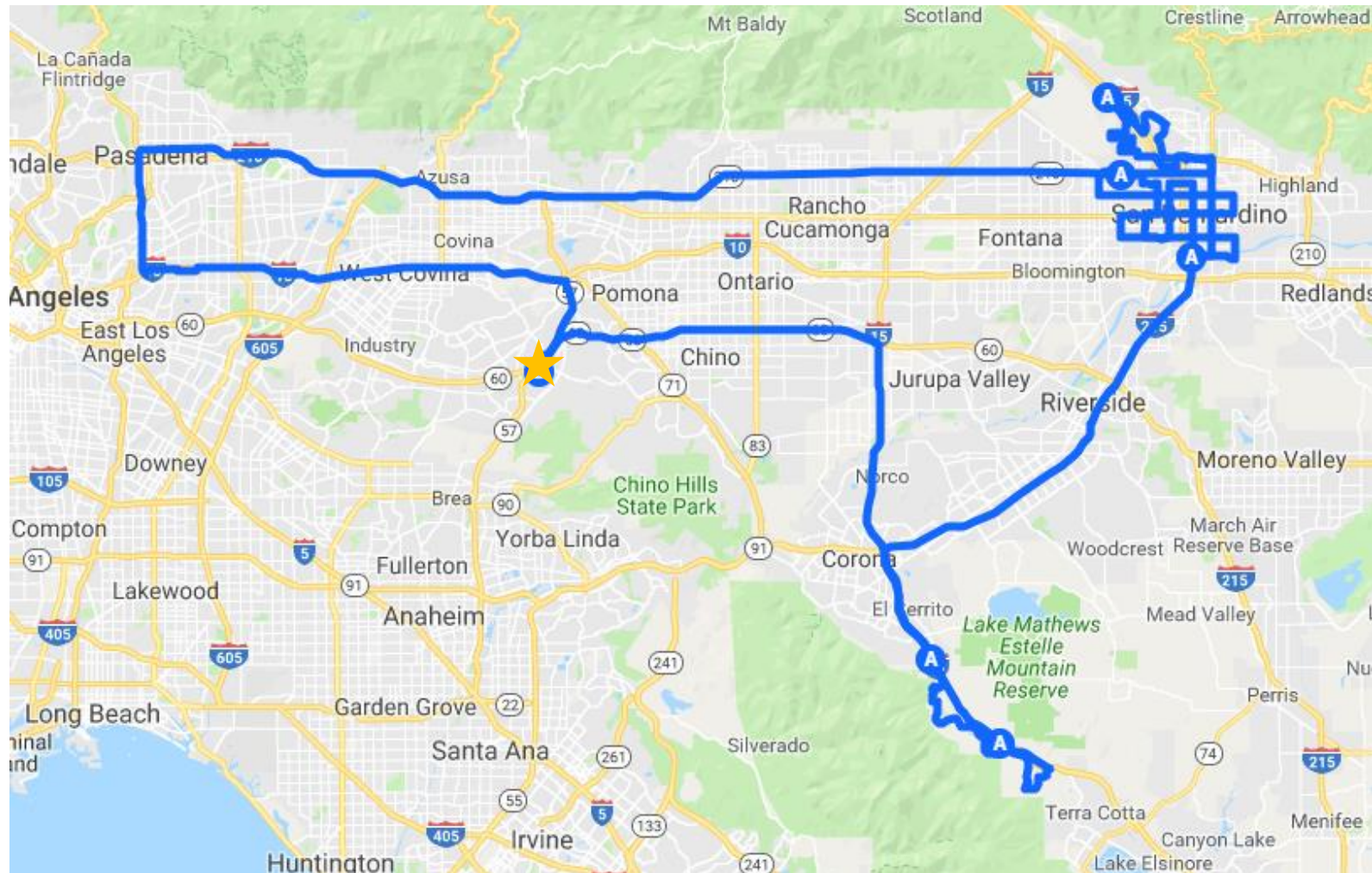

Figure 22: Overview of the IE-SGV route. The mobile platform performs a detailed mapping of the San Bernardino community as part of this route, while passing through Chino, Corona, Temescal Valley, Riverside, and the San Gabriel Foothill cities. This route has characteristics of having a large span of PM, NO₂, and O₃ values. The star marker indicates South Coast AQMD Headquarters. Route is subject to change.

FINAL DRAFT

Mobile Platform Evaluation of Low-Cost Air Quality Sensors

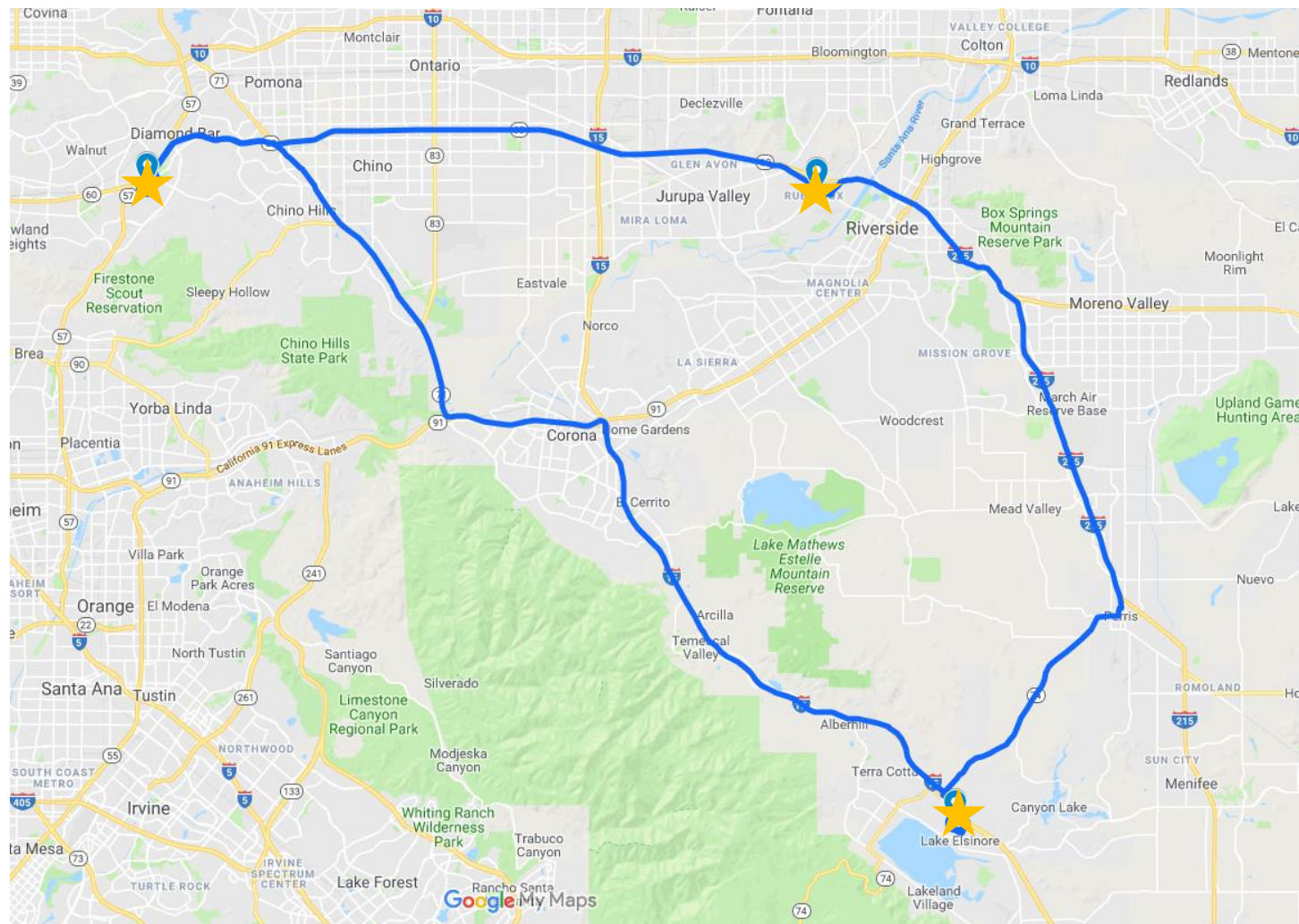

Figure 23: Overview of the RIVR/ELSI Co-location route. The mobile platform co-locates with the RIVR AMS for at least two hours followed by co-location with the ELSI AMS for at least two hours, passing through the Moreno and Temescal Valleys. The star markers indicate South Coast AQMD Headquarters, Riverside-Rubidoux AMS (RIVR), and Lake Elsinore AMS (ELSI). Route is subject to change.

3.4 Navigation

As safety is always first, a driver must always focus primarily on driving with limited distractions. Thus, navigation throughout the test routes must be hands-free and easy for the driver. Visual and audible turn-by-turn navigation is essential for safe and efficient test route guidance. To do so, the test routes designed by AQ-SPEC staff in Google My Maps must be displayed through a third-party source. Utilizing a mobile phone application called OsmAnd (<https://osmand.net>), an app that provides offline maps and navigation, is a helpful platform for this. Using OsmAnd or any other similar software/service allows for effectively visualizing the test routes created by AQ-SPEC staff in Google My Maps, along with audible turn-by-turn navigation.

To import the test routes into OsmAnd requires a series of steps:

- Export the test routes:
 - From Google My Maps, select the map you would like to upload to the OsmAnd app;
 - Select the Settings icon (next to the map title) and select “Export to KML/KMZ”;
 - Select “Download” and save it to your designated location.
- Convert and transfer the test routes:
 - Go to GPS Visualizer (<https://www.gpsvisualizer.com>), a website that can be used to convert map file formats;
 - In the “Get started now!” window, select “Choose File” and select the saved KML or KMZ file;
 - In the same window, select the drop-down menu, select “GPX file” and select “Map it”;
 - In the new page, select “Click to download [unique file name]” and save it to your designated location;
 - Transfer the saved GPX file to a cellular phone by use of USB connection to your computer or by emailing the file and downloading it.
- Import the test routes:
 - Launch the OsmAnd mobile application on the cellular phone;
 - Select the Menu icon (bottom left of the screen) and select “My Places”;
 - Select the “TRACKS” tab, select the “+” icon (bottom left of the screen), navigate through the documents on your cellular phone, and select the downloaded GPX file.

To properly set-up the OsmAnd app to work for the greater Log Angeles area requires a few steps:

- While displaying the map, select the Menu icon (bottom left of the screen) and select “Download maps”;
- Select “North America” then “United State of America” then “California”;
- On the displayed page, download the following by selecting then:
 - Standard map;
 - Los Angeles;
 - Los Angeles North;

Once the test route(s) are imported and the regional maps are downloaded, the turn-by-turn navigation can be started. To do so:

- While displaying the map, select the navigation icon (arrow sign, bottom left of the screen);

- Select “Options” under the “To:” field, select the “GPX route” drop-down menu, and then select “Select GPX...”;
- In the pop-up window, select the desired route;
- In the displayed window, enable “Pass along entire track” then select “CLOSE”;
- Select “Start” and the navigation will begin.

3.5 Reference Analyzer Preparation

3.5.1 Calibration and Zero-Span Checks

Prior to integration into the mobile platform, reference analyzers are checked for acceptable performance.

Reference analyzers without a feasible calibration procedure that could be performed in-house, but are otherwise calibrated by the vendor prior to receipt, only have checks performed as recommended by the user manual (e.g. flow rate and zero checks). These instruments include the Teledyne T640, GRIMM 11-D, DMT PAX, and ADI MAGIC CPC. These instruments are shipped back to the vendor for recalibration per the manufacturer-specified schedule or those specified in Appendix A.

The Teledyne T400 ozone analyzer is calibrated in-vehicle against an ozone certified transfer standard (Thermo 49i) at multiple points from 0 to 450 ppbv.

The Teledyne T500U is calibrated in-vehicle at multiple points using a 90.96/91.11 ppmv NO/NO_x gas standard cylinder mixed with ozone to stoichiometrically create NO₂ at known concentrations using a Teledyne T700U dilution calibrator.

The Teledyne T300 is calibrated in-vehicle at a zero and span point from a zero-air and CO gas standard cylinders.

The LI-COR LI-850 is calibrated in-vehicle at a zero and span point from a zero-air and CO₂ gas standard cylinders.

After integration, zero-span checks are performed for all reference analyzers while they remain in the instrument rack prior to the start of evaluation of any new LCS model. Any particle reference analyzers that measure a mass concentration of more than 0.1 µg/m³ or a number concentration of more than 10 particles/cm³ on a zero check are removed from the vehicle for diagnosis and corrective actions. Any gas reference analyzers that deviate more than ±10% from a span check concentration are recalibrated in-vehicle, or by the frequency specified in Appendix A.

3.5.2 Leak Check

Following integration into the mobile platform, sampling probes and lines leading to and exiting from each reference analyzer were checked for leaks with a vacuum leak detector. Lines must be able to hold -15 inches Hg of vacuum for at least 30 seconds.

3.5.3 Particle Instrument Correction Factor

Following leak checking, vehicle particle reference analyzer loss correction factors are determined while the vehicle is stationary and with windows open. First, the particle analyzers are disconnected from the PM manifold and sample the ambient air until there is at least a 120-second steady-state period observed, from which a mean value for the *i*th measurement period is determined, $\bar{x}_{off,i}$. Next, the particle analyzers are reconnected to the PM manifold and sample the ambient air for another 120-second period, from

which a mean value for the i^{th} measurement period is determined, $\bar{x}_{on,i}$. These measurements are repeated three times. The ratio $f = \frac{\sum_{i=1}^3 \left(\frac{x_{off,i}}{\bar{x}_{on,i}} \right)}{3}$ is the loss correction factor for a given particle analyzer that is applied to the data during analysis.

3.5.4 Co-locations

The mobile platform is co-located with the South Coast AQMD Riverside-Rubidoux (RIVR) and Lake Elsinore (ELSI) Air Monitoring Stations (AMS) at least once per evaluation phase. The co-location involves siting the mobile platform at each AMS for at least 2 hours to sample. This co-location is used as a check that the ambient pollutant concentrations measured by the reference analyzers are consistent with those from a reference AMS. During this co-location, the vehicle engine is turned off to avoid self-contamination, and the laboratory battery bank is connected to an electrical outlet if possible to minimize battery drain. Additionally, sunshade curtains are deployed to cover the windows and the trunk is left ajar to minimize heat buildup in the vehicle while the engine and air conditioning are off. Periodic co-locations are necessary to detect major accuracy issues with the reference analyzers in the mobile platform.

The RIVR AMS is a fully instrumented air quality station that is part of the [EPA National Core Network \(NCORE\)](#). NCORE is a multi-pollutant network that integrates advanced measurement systems for particles, pollutant gases, and meteorology. The station features FRM instrumentation for the NAAQS gas pollutants and FRM and FEM instrumentation for NAAQS particulate matter. The air quality station is also equipped with BAT for particle number, organic/elemental carbon, and other air toxics. Elevation at the site is 248 meters with GPS coordinates: Latitude: 33° 59' 58"N Longitude: 117° 24' 57"W. For a complete report on the RIVR site, view the [Quality Assurance Site Survey Report for Riverside-Rubidoux](#).

The ELSI AMS is another air quality station equipped with FRM/FEM instrumentation for PM₁₀, O₃, NO₂, and CO, and non-FEM instrumentation for PM_{2.5}. Elevation at the site is 410 meters with GPS coordinates: Latitude: 33° 40' 35"N Longitude: 117° 19' 51"W. For a complete report on the ELSI site, view the [Site Survey Report for Lake Elsinore-W Flint Street](#).

If the average concentration ± 1 standard deviation for an individual mobile platform reference analyzer is not within the average concentration ± 1 standard deviation reported by a South Coast AQMD AMS analyzer measuring the same pollutant over the entire co-location period for a given AMS, the analyzer will undergo a zero-span check as described in Section 3.5.1.

3.5.5 Delay Time

There are two possible methods to determine delay times and synchronize measurements from the reference and LCS data in the mobile platform, being 1) signal "fall time" measurement and 2) time delay cross-correlation. The first method is employed for gas reference analyzers, as the duct gas sample probe can be connected to a three-way valve. Since the duct isokinetic PM sample probe cannot be connected to a three-way valve, it is not feasible to create a zero-particle step change condition in the entire sampling duct volume, and thus the second method is used for particle reference analyzers.

3.5.5.1 *Signal Fall Time Measurement*

The first method to determine delay times is measurement of signal fall times and requires extensive equipment and experimentation. The overall probe-tubing-instrument delay time can be determined by imposing steady-state concentrations *at the instrument sampling probe inlet* and measuring the times required for the instrument to report steady concentrations. The parameter used to determine instrument delay time is the fall time from 90% to 10% of the steady-state concentration (t_{90-10}). Fall time

FINAL DRAFT

experiments were repeated three times each, and the mean of all values was averaged to obtain an instrument delay time.

For reference gas analyzers, a three-way valve can be connected to the sampling probe. A zero-air gas cylinder is connected to the three-way valve. First the reference analyzers sample from ambient air to allow for concentrations to reach a steady-state. The valve is then switched to sample from the zero-air cylinder and the concentrations are allowed to reach zero. The fall time for each gas analyzer is determined from these results. Fall times have been measured for all reference gas analyzers *as configured* in the vehicle (Table 4).

Due to the challenge of supplying a step change of either filtered air or a steady particle concentration into the entirety of the duct, fall times are not determined for PM analyzers. Instead, time delay cross-correlation is used to determine the delay times for PM analyzers.

Table 4: Gas analyzer delay times from ambient-to-zero air fall time measurements.

Instrument	Parameter	t_{90-10} , s
Teledyne T400	O ₃	4
Teledyne T500U	NO ₂	13
Teledyne T300	CO	36
LI-COR LI-850	CO ₂	2

3.5.5.2 *Time Delay Cross-Correlation*

The second method would employ post-processing of collected data to determine the delay time between reference equipment and LCS data using cross-correlation [10]. This method is efficient and rapid and can be applied for each individual test drive. Additionally, it can be used to determine the delay time of LCS in all three evaluation phases.

A common or related parameter would have to be measured by two instruments and would ideally show a large range through the test duration. Usually, most reference equipment and LCS measure temperature and/or RH. The reference T/RH meter in the sampling duct (Fisherbrand Traceable Humidity Meter) would provide the temporally-fixed signal against which all other reference equipment and LCS T/RH signals would be synchronized against. Depending on the time span covered by a driving test, either temperature or RH may be the more favorable signal in terms of range. Subsequent cross-correlation can be performed on equipment that does not measure T/RH, but still shares a common parameter (e.g. GlobalSat SiRF Star GPS and GRIMM 11-D GPS). For some LCS, the T/RH values reported, if any, are more reflective of conditions inside or near the sensor measurement volume as opposed to ambient T/RH, in which case near-stationary LCS and reference pollutant measurements (those collected while the mobile platform is traveling at 0-3 mph) are used for the time-delay cross-correlation synchronization. These near-stationary data points would be omitted for purposes of comparing sensor performance against the reference analyzer.

In short, time delay cross correlation involves shifting a reference or LCS signal forwards and backwards in time, and then computing the correlation with the temporally-fixed signal. The time shift that results in the greatest correlation determines the delay time of the reference equipment or LCS and allows for all data to be spatially synchronized. This procedure is conducted in *R* using the *ccf* function in the *stats* package [11, 12].

FINAL DRAFT3.6 Pre-Test Steps

Prior to any testing event, the following procedures are conducted:

- Power on the uninterruptible power supply for the Agilaire 8872
- Ensure all instruments have their switches on the On position. Note that the switch for the 8872 is always in the On position, even when the mobile platform is not in use.
- Ensure that a monitor is connected to the Agilaire 8872 via HDMI
- Prepare the Agilaire 8872 to collect data
 - Login to Agilaire 8872 laptop
 - Open the AV Trend software
 - Reports > Internal Reports > Table Size Info
 - Check that “All Tables Reserved” is < 1,000,000
 - If it exceeds 1,000,000, Utilities > Archive/Purge Data > Purge Journal Messages
 - Choose Data Older than 1 second
 - Choose Purge Data as the action
 - Click on the Process Data button
 - Close the tab and refresh the table
 - Home > Utilities > Site Node Logger Toolbox
 - Change Refresh Interval to 1 second
 - Enable the Collection checkbox for each desired parameter
- Power on each instrument and equipment one-at-a-time (note time on the Test Log Form; see Appendix C) by switching on all the rack-mount power distribution unit switches. The rack-mount switch for the Agilaire 8872 should always remain in the On position, even when the vehicle is parked overnight.
- Ensure each instrument is streaming data to the 8872 correctly by watching for new values to be displayed on the Site Node Logger Toolbox
- Power on the Alcatel LINKZONE Wi-Fi hotspot
- Power on the LCS
- Power on the GPS unit by pressing and holding the power button on the unit for 5 seconds
- Power on the laptop and log in with the AQ-SPEC login name and password
- Ensure all required units are connected to the mobile platform laptop via USB-to-serial cable plugged into the USB hub
- Start data logging for the connected instruments
 - Exttech Instruments Anemometer (COM 7)
 - Launch the Tera Term software
 - Select Serial and the corresponding Port in the drop-down menu
 - Setup > Terminal...
 - In the “New-line” section, select “CR+LF” for both “Receive” and “Transmit”
 - Select Ok
 - Ensure the unit is streaming data to the Tera Term software
 - File > Log...
 - Select the box next to “Timestamp”
 - Input the file name
 - Select the location to save the file
 - Select Save
 - Fisherbrand Hygrometer (COM 8)
 - Launch the Tera Term software
 - Select Serial and the corresponding Port in the drop-down menu

- Setup > Serial port...
- In the “Baud rate:” drop-down menu, select “1200”
- In the “Data:” drop-down menu, select “7 bit”
- Select OK
- Ensure the unit is streaming data to the Tera Term software
- File > Log...
- Select the box next to “Timestamp”
- Input the file name
- Select the location to save the file
- Select Save
- GlobalSat SiRF Star GPS Receiver (COM 24)
 - Launch the Tera Term software
 - Select Serial and the corresponding Port in the drop-down menu
 - Ensure the unit is streaming data to the Tera Term software. If GPS coordinates are zeros, try pulling the vehicle forward from out under the roof eave so that the GPS antenna has direct line-of-sight with the sky.
 - File > Log...
 - Select the box next to “Timestamp”
 - Input the file name
 - Select the location to save the file
 - Select Save
- GRIMM 11-D
 - On the desktop, right click on the GRIMM Spectrometer software, select “Run as administrator” and select “Yes” when prompted to provide authorization to run
 - Select Port
 - In the drop-down menu, select “COM6”
 - Select “Connection to device”
 - Once the device is connected, select “Exit X” to close the window
 - Time Interval
 - If the selection is not set to 6 seconds, select “6 seconds” in the drop-down menu
 - Select “Initialize”
 - Select “Ok” to close the window
 - Synchronization
 - Select “Get current PC and OPC time”
 - If there is a variation between the PC and OPC times, select “Set OPC to PC time”
 - If there still is a variation between the PC and OPC times, repeat the process until the two times match exactly
 - When they match, select “Exit X” to close the window
 - User Settings
 - “Result file path:” – select “C:\Grimm\Grimm_Measurement_Data” by using the folder icon on the right
 - “File name prefix:” – input a name for the data files that follows the template “YYYY.MM.DD – vehicle – route code and version”
 - The “Comment,” “User name,” and “Location” fields are voluntary to fill in and can be left blank
 - Select “Ok”

- Start Device
- Start Data Storage
- Ensure the “Next cycle [s]” bar is filling to 6 seconds and repeating with new values in the “Port telegram” box after each cycle
- LI-COR LI-850
 - On the desktop, right click on the LI-850 software, select “Run as administrator” and select “Yes” when prompted to provide authorization to run
 - Select “Connect”
 - In the “Connect to:” drop-down menu, select “1 – COM14 LI-850”
 - In the “Data rate:” drop-down menu, select “1.0” second
 - Select “Connect”
 - Select “Setup Logging”
 - In the “Logging to file:” field, select “Select File”
 - Select the desired test folder location
 - Select “Save”
 - Leave all selections as-is (all boxes checked-in)
 - Select “Start Logging”
 - Exit the window
 - Ensure the values are refreshing each second
- Ensure the silica gel dryer(s) are blue in overall color
- Ensure the water reservoir for the ADI MAGIC is filled
- Ensure the duct fan is powered on
- Ensure the collective instrument exhaust tube is exhausting out of the vehicle
- Ensure all LCS are connected to the Wi-Fi hotspot and uploading data to their respective platforms as necessary
- Ensure all LCS that connect via cable communications are connected and logging as necessary
- Ensure the duct end pieces are securely attached
- Close all windows and seal any gaps
- Close the rooftop enclosure box, if sensors are mounted inside. Open appropriate blast gates for flow path desired. Secure the rooftop enclosure box lid with zip ties if necessary.
- Power on dashboard cameras, if applicable
- Ensure all items on the Test Log Form checklist have been addressed and all blank fields have been filled
- Note the time for the start of the test
- Begin drive

3.7 Low-Cost Sensor Evaluation Phases

3.7.1 Phase 1 – On-Road Controlled Flow Velocity Sampling

The LCS Phase 1 evaluation period is the time during which LCS units are installed *inside* the mobile platform in triplicate and obtain sample from the controlled flow, transverse sampling duct. This phase represents a complex approach to mobile monitoring with LCS, requiring significant capital and technical resources. The LCS are protected from sun exposure, and the vehicle cabin environment is maintained at 21-24°C with the vehicle air conditioning controller.

If the LCS units being evaluated have a sample intake driven by a pump, and their inlets can connect to gas fittings and tubing, they are evaluated by mounting on any available space on the instrumentation racks and sampling from the reference gas or PM analyzer manifold, depending on what type of pollutant the LCS units measure. Minimal, but equal lengths of PTFE (for gas pollutants) or conductive silicone (for

particles) tubing are used for connecting the LCS units to the respective reference analyzer manifold to maximize sample representativeness. Sampling from the same manifold as the reference analyzers also reduces measurement biases between the reference analyzers and the LCS.

If LCS units have a sample intake driven by a fan, or their inlets cannot be easily connected to tubing, they are mounted in the transverse sampling duct so that the units are wholly enveloped in the sample. A mounting table on a sliding rail is integrated into the duct to allow for flexibility in positioning the LCS inside the sampling duct. Due to the variety of sizes and sampling intake configurations of fan-based LCS, there is no single mounting position or orientation appropriate for all LCS. Therefore, fan-based LCS are mounted in the duct such that their sample intake is perpendicular to the duct flow centerline and as near to the duct flow centerline as practicable. If the sensor units are compact enough, they may be mounted in a radially symmetric pattern around the duct flow centerline. If this is not possible due to space constraints, then the sensor units are mounted in series along the duct longitudinal axis. The flow velocity surrounding the sensor units, monitored with an Extech 407119 hot wire anemometer, is controlled to be non-turbulent (Reynolds number < 4000).

Figure 24 shows schematically how LCS units are mounted in the vehicle or sampling duct, depending on sample inlet characteristics of the LCS, while Figure 25 shows an example LCS mounted serially in the duct.

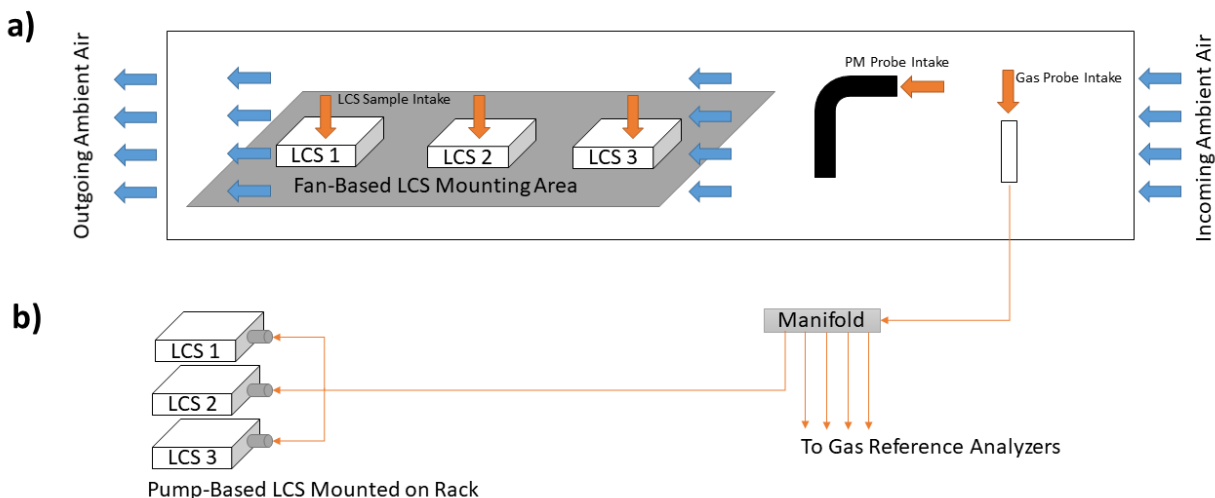

Figure 24: Schematic of Phase 1 LCS mounting for a) fan-based sampling LCS units and b) pump-based sampling LCS units. Fan-based LCS units must be mounted in the sampling duct in series such that their sample intake is perpendicular to the duct flow centerline. Pump-based LCS units can be mounted at any convenient location on the instrumentation racks, as long as each unit has an equivalent and practicably minimal sampling line length from the manifold.



Figure 25: Example Phase 1 mounting configuration of fan-based LCS inside sampling duct downstream of reference analyzer probes.

If the sensor units cannot fit inside the sampling duct, they will not undergo Phase 1 testing. If the LCS is already designed by the manufacturer for mobile sampling and direct mounting to a vehicle rooftop, the unit will not undergo Phase 1 testing.

The Co-location route is performed at least once during the Phase 1 evaluation period. The IE-SGV route is performed at least three times during the Phase 1 evaluation period. A Phase 1 evaluation period typically lasts 1 week, exclusive of mobile platform maintenance or repair activities required.

3.7.2 Phase 2 – On-Road Partially Uncontrolled Flow Velocity Sampling

The LCS Phase 2 evaluation period is the time during which LCS units are installed *outside* the mobile platform, but *inside* an enclosure mounted on the vehicle roof. This phase represents a simplified approach to mobile monitoring with LCS. The LCS are protected from sun exposure, but the temperature is not maintained or moderated; in addition, the LCS now potentially experience exterior turbulent flow conditions while housed in the enclosure on the vehicle rooftop.

The enclosure consists of a polyethylene tote box with a lid, with exterior dimensions of 19.75 x 11.75 x 7.25 inches (0.5 x 0.3 x 0.2 m) and interior dimensions of 16.25 x 8.63 x 6.75 inches (0.4 x 0.2 x 0.2 m). The enclosure box has various openings that can be opened or closed to allow for different air flow configurations when the vehicle is in motion. Three holes were created in the enclosure, each measuring 4 inches (0.1 m) in diameter, and a blast gate was mounted over each hole so that individual holes can be left open or closed to influence the ambient air flow path through the enclosure. There are concentric holes on the front and back faces of the enclosure, both centered 5 inches (0.127 m) from one side of the enclosure and 3.6 inches (0.092 m) from the bottom of the enclosure. There is also one hole on the top face of the enclosure, centered at 5 inches (0.127 m) from one side of the enclosure and 4 inches (0.102 m) from the front of the enclosure (Figure 26a). The enclosure is configurable for two different flow paths to interact with the LCS mounted inside: 1) a “front-to-back” path (Figure 26b) in which the front and back blast gates are open and 2) a “top-to-back” (Figure 26c) in which the top and back blast gates are open.

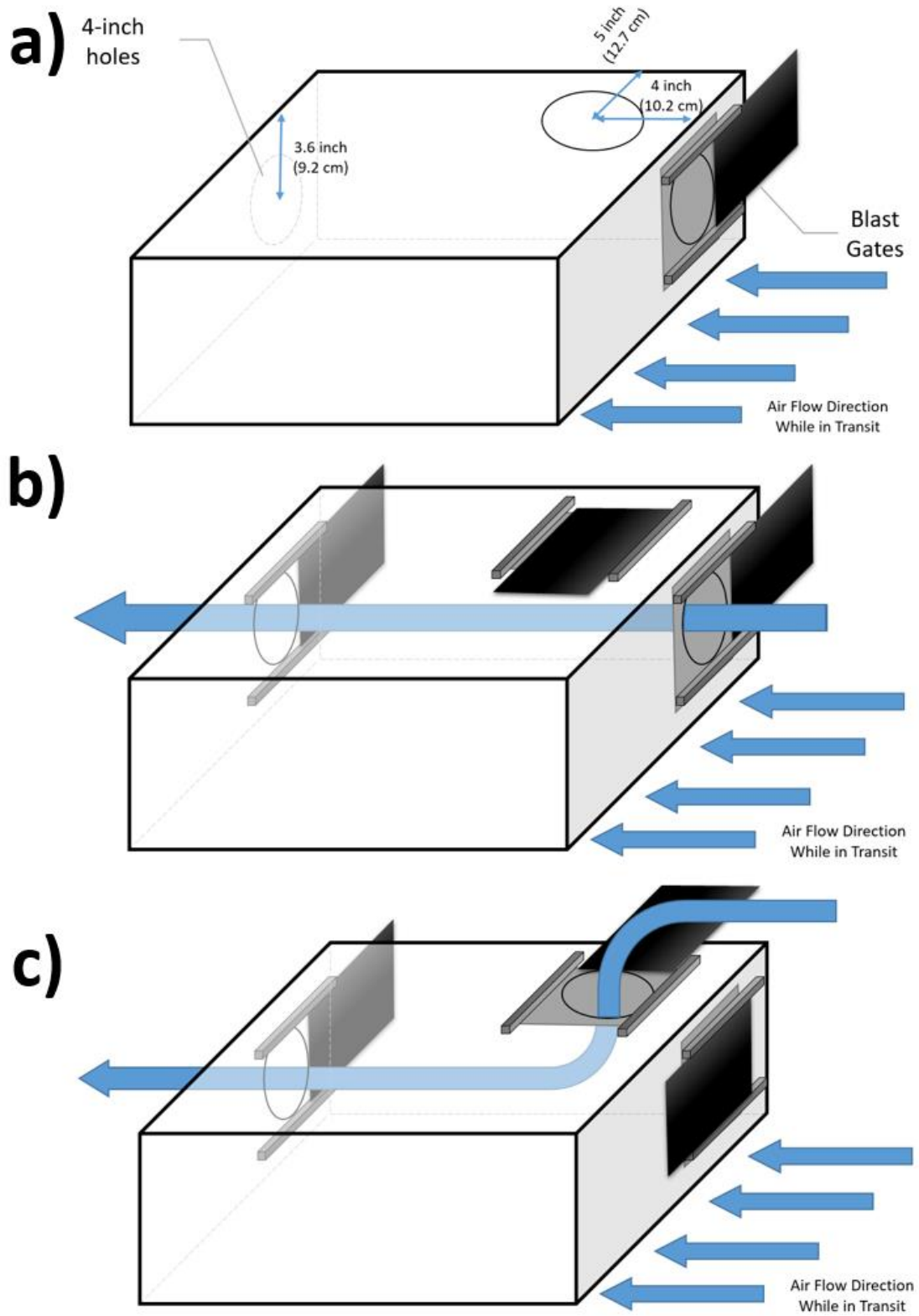

Figure 26: Diagram of Phase 2 polyethylene tote box enclosure, showing a) relative positions of openings, b) blast gate configuration for a "front-to-back" sample flow path, and c) blast gate configuration for a "top-to-back" sample flow path.

Phase 2 has “preliminary” and “clustered” subphases. The preliminary subphase probes for the optimal LCS mounting location inside the enclosure, while the clustered subphase evaluates LCS in triplicate in the optimal location identified from the preliminary subphase. Reference analyzers still sample from the sampling duct. A Phase 2 evaluation period typically lasts about 6 weeks, exclusive of mobile platform maintenance or repair activities required.

3.7.2.1 Preliminary Subphase

The preliminary subphase of Phase 2 is to test LCS units in different locations in the rooftop enclosure to identify the mounting location that results in the optimal performance of the LCS. In each flow configuration (front-to-back or top-to-back), LCS are initially mounted on the transverse centerline of the enclosure, spaced equidistantly, with the sensor inlet facing perpendicular to the flow path (note that units are not tested in triplicate in this preliminary subphase, since each unit experiences a different surrounding flow velocity). Preliminary subphase test drives are repeated until each LCS unit has had an opportunity to be mounted in each location for at least one IE-SGV route drive, for each flow configuration. Results from this initial sensor mounting pattern are analyzed, and the location of the sensor showing the highest correlation with a reference analyzer is identified (the possible “optimal” location) for a given flow configuration.

If no mounting location is obviously optimal over other locations from the initial Phase 2 testing, the sensors will be positioned in the center of the enclosure box for the subsequent clustered subphase. If the sensor units are too large such that only one unit can be mounted inside the enclosure box, then this preliminary subphase investigation is not conducted. If the LCS is already designed by the manufacturer for mobile sampling and direct mounting to a vehicle rooftop, the unit is not subjected to this preliminary subphase.

3.7.2.2 Clustered Subphase

The clustered subphase of Phase 2 is to test LCS units in triplicate in the optimal location in the rooftop enclosure identified from the preliminary subphase, for a given flow configuration. In each flow configuration (front-to-back [“Phase 2A”] or top-to-back [“Phase 2B”]) LCS are mounted in a tight cluster in the optimal location identified for that flow configuration, with the sensor inlet facing perpendicular to the flow path. Clustered subphase IE-SGV test drives are repeated at least three times, for each flow configuration. The Co-location route is performed at least once during each clustered subphase evaluation period.

If the sensor units are too large such that three units cannot be mounted inside the enclosure box, then only a single unit with the highest correlation to the reference data from Phase 1 will be tested in Phase 2; this unit will be mounted in the center of the enclosure box. If the LCS is already designed by the manufacturer for mobile sampling and direct mounting to a vehicle rooftop, the unit is not subjected to this clustered subphase.

Figure 27 and Figure 28 show schematically how LCS units are mounted in the rooftop enclosure box for the preliminary and clustered subphases, for both the front-to-back and top-to-back flow configurations, respectively. Figure 29 shows an example LCS mounted in the rooftop enclosure box for a preliminary subphase evaluation, while Figure 30 shows an example LCS mounted in the box for a clustered subphase evaluation.

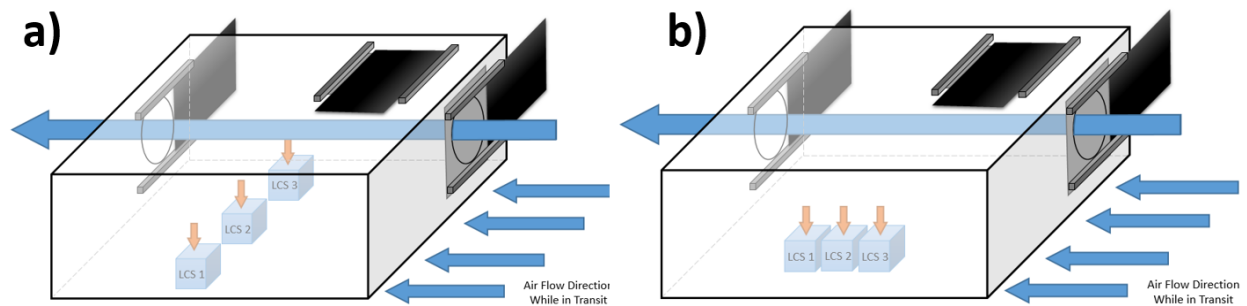

Figure 27: Illustration of sensor unit testing in Phase 2 with a front-to-back flow configuration. The front and back blast gates are open, and all other blast gates are closed. Ambient air moves through the enclosure from the front to the back, at velocities related to the vehicle speed, assuming no external wind field. a) Initially LCS are mounted along the enclosure depth centerline, equidistantly along the enclosure width, to identify the optimal location for the front-to-back flow path. b) Finally, LCS are mounted in triplicate in the optimal location for this flow path (“Phase 2A”); the optimal location shown in this figure is for exemplary purposes.

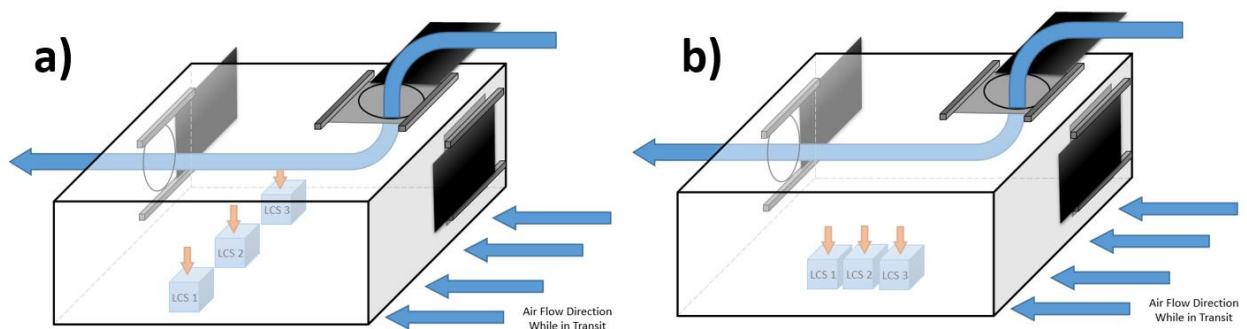

Figure 28: Illustration of sensor unit testing in Phase 2 with a top-to-back flow configuration. The top and back blast gates are open, and all other blast gates are closed. Ambient air moves through the enclosure from the top to the back, at velocities that may be related to the vehicle speed, assuming no external wind field. a) Initially LCS are mounted along the enclosure depth centerline, equidistantly along the enclosure width, to identify the optimal location for the top-to-back flow path. b) Finally, LCS are mounted in triplicate in the optimal location for this flow path (“Phase 2B”); the optimal location shown in this figure is for exemplary purposes.



Figure 29: Example preliminary subphase mounting of LCS, in which sensor units are mounted equidistantly along the width of the enclosure box, to probe for the optimal sensor location for enclosure box sampling. After identification of optimal sensor location, the sensor units are then mounted in a tight cluster in that location for additional Phase 2 testing.



Figure 30: Example clustered subphase mounting of LCS, in which sensor units are mounted in a tight cluster at the optimal sensor location for enclosure box sampling, identified from the preliminary subphase. In the case of this LCS, the sample inlet tubes are bound together to sample from the same location in the enclosure box.

3.7.3 Phase 3 – On-Road Uncontrolled Flow Velocity Sampling

The LCS Phase 3 evaluation period is the time during which LCS units are installed *fully exposed on the exterior* of the mobile platform. This phase represents the simplest approach to mobile monitoring with LCS. The LCS are not housed or covered, and thus the units are exposed to sun, inclement weather, and turbulent flows.

A rack constructed of T-slotted aluminum framing rails on the vehicle rooftop allows for mounting of LCS units. Depending on the sensor unit dimensions, geometry, or existing threaded holes, the units may be strapped or bolted to the rooftop frame. LCS are mounted in triplicate, equidistantly along the width of the aluminum slotted rooftop rack of the vehicle just above the windshield. Phase 3 testing involves three sub-phases in which the LCS are mounted on the rooftop rack such that sensor sample inlets are in a different orientation relative to the direction of travel (Figure 31):

- Sub-phase A: LCS positioned in the same “default” manner as the LCS would be in a stationary application (as instructed, recommended, or suggested based on user manuals, brochures, or marketing photographs)
- Sub-phase B: LCS sample inlet facing toward the direction of travel
- Sub-phase C: LCS sample inlet facing away from the direction of travel

Reference analyzers still sample from the sampling duct. The Co-location route is performed at least once during each Phase 3 sub-phase evaluation period. The IE-SGV route is performed at least three times during each Phase 3 sub-phase. A Phase 3 evaluation period typically lasts about 3 weeks, exclusive of mobile platform maintenance or repair activities required.

If the LCS is already designed by the manufacturer for mobile sampling and direct mounting to a vehicle rooftop, the unit will not be tested in different orientations; instead it will be only tested in the mounting configuration and sample inlet orientation that is instructed, recommended, or suggested by user manuals, brochures, or vendor images of the unit.

Figure 31 shows schematically how LCS units are mounted on the rooftop rack for Phase 3 testing, while Figure 32 shows an example LCS mounted on the rooftop rack for Phase 3 evaluation.

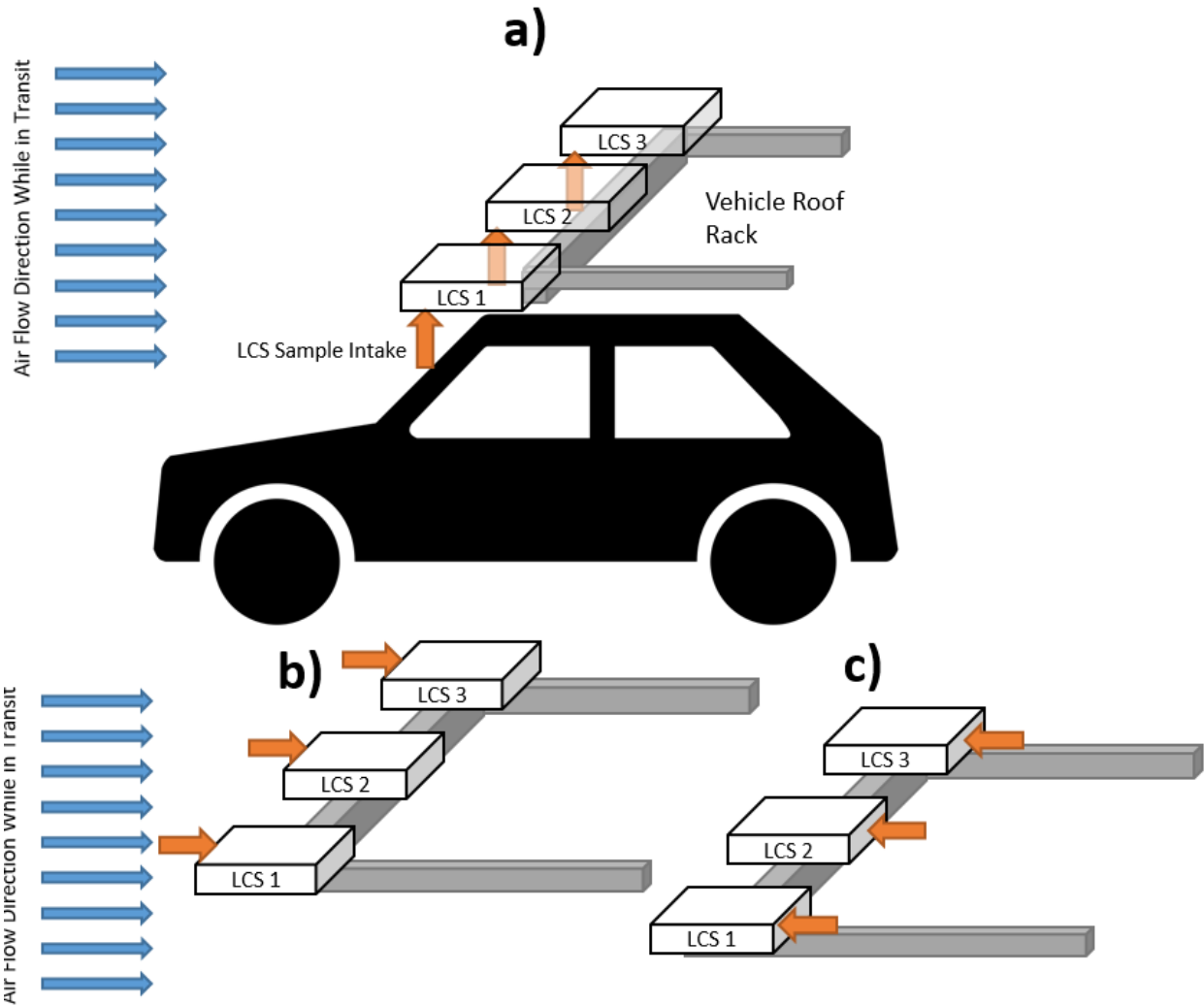

Figure 31: Phase 3 evaluation LCS mounting orientation for a) sub-phase A where the unit is positioned as if it were conducting stationary sampling and the sample inlet faces the “default” direction required, recommended, or suggested by the vendor, b) sub-phase C where the sample inlet faces toward the direction of travel, and c) sub-phase D where the sample inlet faces away from the direction of travel.



Figure 32: Example Phase 3 mounting configuration of LCS on vehicle roof rack with sensor units oriented “default” orientation consistent with a stationary application. This method represents the simplest approach to mobile monitoring.

3.8 Post-Test Steps

At the end of any testing event, the procedures in the following sub-sections are conducted.

3.8.1.1 Laboratory

- Complete the Test Log Form.
- Check the GRIMM 11-D condensation bottle for any liquid and empty if necessary.
- Check the ADI MAGIC CPC humidifier block water level and refill with distilled water if necessary.
- Check the color of the silica gel in the dryers and exchange with regenerated silica gel if necessary.
- Charge the laboratory battery bank and ensure that the vehicle cabin has a small opening for ventilation of H₂S gas.
- Close any opened blast gates on the rooftop enclosure box.
- Power off the mobile hotspot by holding the power button until the LED lights turn off.

3.8.1.2 Instruments

- Stop data logging for the connected instruments
 - Extech Instruments Anemometer
 - Exit the Tera Term program
 - Fisherbrand Hygrometer
 - Exit the Tera Term program
 - GlobalSat SiRF Star GPS Receiver
 - Exit the Tera Term program
 - Power off the GPS device by holding the power button for 5 seconds until the LED light blinks.
 - GRIMM 11-D

- Stop Device
- Open Files
 - Select file if not auto-filled with desired test data file
 - Select “Data transfer to Excel” (allow time for all worksheets to process)
 - Check for data completion
 - File > Save As > Select desired test folder > Save
 - Close Excel
 - Select “Exit” to close the “Open Files” window
- Select “Stop & Exit”
- Select “Stop system and exit program”
- LI-COR LI-850
 - Select “Stop”
 - Exit the program

3.8.1.3 Data Download

- Agilaire 8872
 - On the Site Node Logger Toolbox tab, disable all enabled parameters by selecting the cells that are “ON”
 - Home > Reports > Average Reports > Basic Data Export
 - Select desired date/time range (time in PST and 24-hour format)
 - Select time interval
 - Select parameters
 - Click “Generate Report” and allow for the software to generate a report
 - Click “Excel”
 - Deselect “Export hyperlinks”
 - Select “Raw data mode”
 - Click “OK”
 - Select save location and input file name
 - Save
 - Select “No” when asked to “Open file now?”
 - Repeat as necessary for all desired data time intervals.
 - Exit the AV Trends software
 - Shut down the 8872 by following the typical Windows shutdown procedures
 - Windows Start > Power > Shut down
 - Power off the uninterruptible power system serving the Agilaire 8872 and its monitor off after proper shutdown procedures have been executed. Do not switch off the rack-mount power switch for the Agilaire 8872.
- Laptop
 - Open the test data folder (where all instrument data was saved for that day’s testing)
 - Copy the files to a USB drive
 - Open the Grimm_Measurement_Data shortcut on the desktop
 - Copy the four .dat files generated by the Spectrometer software to a USB drive
- Upload all copied files from the 8872 and laptop to the network shared drive

3.8.1.4 Data Purge

- Power on the Agilaire 8872
- Select the Santa Fe profile
- Input the required password

- Double-click the AV Trends software on the desktop
- Utilities > Archive/Purge Data > Purge Average Data
- Select desired date/time range
- Select “Purge Data”
- Select Average Interval in the designated drop-down menu
- Select “All Parameters”
- Select “Process Data Archive/Purge”
- Repeat as necessary for all desired Average Intervals.

3.8.1.5 Database Backup

The database backup procedures are completed every 3-4 weeks.

- Power on the Agilaire 8872
- Select the Santa Fe profile
- Input the required password
- Double-click the AV Trends software on the desktop
- Turn off all parameter data collection
 - Utilities > Site Node Logger Toolbox
 - Click on all “ON” cells for each parameter that is on
- Purge all historical data
- Status Displays > Task Status
- Select the box to enable Refresh Status Automatically
- Select [Local Drive Database Backup Task]
- Select “Execute Scheduled Task Now”
- Wait for “Success” to display as the status
- Repeat the process for [USB Drive Database Backup Task]
- Check the backup folders to confirm backup files were updated
 - (C:) > AVData Backup for SQL > AVData.bak
 - (Z:) > SQLServerBackups
- Compress the backup file on the (C:) drive
 - Right-click on the AVData.bak file
 - Select “Sent To”
 - Select “Compressed (zipped) folder”
 - Name the new compressed backup file with the following format:
 - AVData_YYYYMMDD.zip (input date for YYYYMMDD)
- Copy the compressed backup file to a USB
- Upload the backup file to the AQ-SPEC shared drive

FINAL DRAFT**4 Data Treatment**

The mobile platform evaluation of the sensors is based on a side-by-side comparison between the LCS being tested and the reference instrument(s) measuring the same pollutant(s). A series of performance-related parameters which would affect actual air quality measurements of LCS deployed on vehicles are tested with a series of carefully designed mobile platform experiments. These parameters include:

- Mean
- Absolute and relative standard deviations (SD, RSD)
- Mean bias, mean absolute, and root mean square errors (MBE, MAE, RMSE)
- Range-based intra-model variability (IMV)
- Data recovery
- LCS lag times
- Coefficient of determination (R^2) as a function of velocity
- Phase 2 preliminary subphase optimal enclosure mounting location

In general, an experiment consists of three phases; 1) an on-road evaluation phase under controlled non-turbulent flow conditions, 2) an on-road evaluation phase under partially-controlled turbulent flow conditions at different flow path configurations, and 3) an on-road evaluation phase with uncontrolled turbulent flow conditions at different sample inlet orientations relative to the direction of travel. Table 5 summarizes the evaluation parameters derived from each testing phase.

Table 5: Summary of evaluation parameters for each phase of mobile platform testing

Evaluation Parameter	Phase 1 – Sampling Duct	Phase 2 – Rooftop Enclosure	Phase 3 – Fully Exposed
Mean	✓	✓	✓
SD, RSD	✓	✓	✓
MBE, MAE, RMSE	✓	✓	✓
IMV	✓	✓	✓
Data recovery	✓	✓	✓
LCS lag time	✓	✓	✓
LCS vs. Reference R^2 by velocity	✓	✓	✓
Optimal LCS location in enclosure		✓	

4.1 Quality Control

Reference analyzers and sensor data are first validated following basic QA/QC procedures (e.g., obvious outliers, negative values, and invalid data points are eliminated from the dataset).

4.1.1 Limits of Detection

Reference analyzer data that falls below the instrument limit of detection (LOD) is also flagged and not considered for the analysis dataset. Reference analyzers sampled zero air for at least 30 minutes, and then calculating the average and standard deviation of the reported values for the next 15 minutes; the LOD was calculated as the average plus three standard deviations during the 15-minute period. Table 6 lists the LOD for each reference analyzer. As the LOD for the Teledyne T300 CO analyzer and DMT PAX black carbon analyzer are quite high relative to typical ambient concentration, LCS that measure CO or black carbon will require special evaluation procedures, which may include mobile sampling inside tunnels, parking garages, and driving near wildfires or diesel trucks, to sample high enough concentrations.

Valid reference data (which is collected at 1- to 6-second intervals) is matched to the sensor data by timestamp, after time synchronization adjustments have been applied. The averaging time interval used shall be the longer reporting interval from the reference analyzer and LCS being compared. For example, if a reference analyzer reports every 3 seconds but the LCS reports every 60 seconds, then the reference analyzer data shall be averaged across 60 second intervals for comparison against the LCS. Statistical analysis is then conducted to quantitatively evaluate the parameters as described in Section 4.4.

Table 6: Limit of detection levels for each reference analyzer in the mobile platform.

Instrument	Parameter ⁵	LOD
GRIMM 11-D	PM _{10/2.5/1.0}	0.0 µg/m ³
Teledyne T640	PM _{10/2.5}	0.1 µg/m ³
Teledyne T400	O ₃	2.7 ppb
Teledyne T500U	NO ₂	0.19 ppb
Teledyne T300	CO	0.109 ppb
LI-COR LI-850	CO ₂	1.5 ppm
ADI MAGIC	Particle Count	0 cm ⁻³
DMT PAX	Black Carbon	0.755 µg/m ³

4.1.2 Near-Stationary Data

Reference analyzer and LCS data collected while the mobile platform is traveling at a velocity of less than “walking speed”, or 3 miles per hour (1.34 m/s), are discarded from further analysis. Data collected while the mobile platform is traveling at near-stationary speeds is not considered in the evaluation because this data is not representative of mobile sampling and can convolute the performance of an LCS in a *mobile* evaluation.

4.1.3 Local Vehicle Tailpipe Emissions

Of special consideration for mobile collection of sample air is the matter of local, transient tailpipe emissions from vehicles introducing spikes in the readings during testing. While tailpipe emissions are typically diluted by ~2-3 orders of magnitude at a downwind distance of several vehicle heights [13], high-polluting vehicles can still introduce non-representative levels of pollutants that influence the data.

Reference analyzers can typically provide a much greater temporal resolution than LCS, allowing for transient tailpipe emissions to possibly be discerned in the reference data time-series. In contrast, LCS typically provide observations at intervals of at least 60 seconds, thereby subduing the prominence of transient tailpipe emissions in the sensor data time-series.

Since the LCS are sampling the same ambient air as the reference analyzers from the duct and the presence of transient tailpipe emissions should affect both time-series in a similar manner, if the time-series are adjusted to account for measurement delay times. Due to the typically longer reporting intervals

⁵Although reference analyzers may output a value for PM₁₀, further work is needed to improve the sampling system for PM₁₀. Currently, PM₁₀ is not a pollutant that will be evaluated on the mobile platform.

of LCS compared to reference analyzers, transient tailpipe signals may appear more prominently in reference data.

4.1.4 Anisokinetically-Sampled Particle Data

Of special consideration unique to mobile collection of particles is the matter of data validity for anisokinetic collection of particles by reference analyzers.

For the Teledyne T640 and DMT PAX analyzers, data is invalidated when the rolling 1-hour averaged monitored duct flow velocity is not within $\pm 10\%$ of the duct flow velocity required for isokinetic sampling by the PM probe. Since the GRIMM 11-D provides particle size mass distributions, the data may be corrected to account for anisokinetic sampling using the Particle Loss Calculator tool [8] if the duct flow velocity is significantly above that required for isokinetic sampling for the majority of the test drive.

4.1.5 Reference Analyzer Sample Relative Humidity

In the case of reference analyzers making particle measurements, proper aerosol conditioning must be achieved for high-quality data. There is the possibility that the silica gel diffusion drying system may be overwhelmed by the ambient relative humidity and the sample is not sufficiently dried at the point of measurement.

For some single-component salt particles, the efflorescence relative humidity (ERH) ranges from 35-45%. However, urban aerosol composition is complex and variable, and therefore the maximum RH for a sufficiently conditioned sample is unclear. In the case of particles that are very acidic or have significant amounts of ammonium nitrate, particles may remain liquid at low RH values. Salt particles with soot inclusions may also remain liquid at low RH values since soot does not contain regular atomic arrays that encourage salt crystallization; on the other hand, mineral inclusions can increase the ERH by providing a well-ordered atomic array for crystallization. [14, 15]

For the Teledyne T640 and GRIMM 11-D analyzers, data may be invalidated when the respective instrument sample RH exceeds 50%.

4.1.6 Reference Analyzer Warnings

If a reference analyzer has a logged temperature or flow rate excursion, the data collected from that analyzer may be invalidated during the warning period.

4.2 Data Adjustments

Particle reference analyzer data are adjusted by their PM loss correction factors (see Section 3.5.3) by multiplying the raw data by the particle loss correction for that analyzer. All reference analyzer data is also synchronized against fixed measurements (e.g. GPS or duct T/RH) using either measured t_{90-10} values or using the time delay cross-correlation technique (see Section 3.5.5). In addition, LCS data is synchronized against the reference analyzer that also measures the same pollutant using the time delay cross-correlation technique; the time shift required for the LCS units is recorded for determination of LCS lag time.

4.3 Post-Test Data Preparation

Following mobile surveys, the files are processed to create a single comprehensive data file containing all parameters recorded by the instruments on the vehicle as well as relevant metadata and QA/QC information. In addition to the comprehensive data file, other outputs of this processing include a "Log file" containing metadata and completeness data for each reference instrument on board the vehicle, a

“Statistics file” containing basic statistics (e.g., mean, median, 5th, and 95th percentile values) for each reference instrument, and an interactive Leaflet map in which each point displays the associated timestamp. These additional output fields provide quantitative metrics by which to easily assess and compare drives at a high level. The availability of the single comprehensive data file facilitates more efficient analysis of mobile surveys and sensor evaluations as it allows for additional programs to be written with which these data files will be consistently compatible. Furthermore, consistent data formatting for each survey makes possible aggregate analysis of multiple surveys. This data processing is achieved using a program coded in the statistical language *R*, according to the steps outlines below.

Overview of post-survey processing of mobile platform data:

- Select all files available from a drive (program can process all possible files available, but is also robust to missing files)
- Import all available files and format for merging
- Build new complete data frame based on the earliest and latest time observed across available files, with 1-second resolution (i.e. the highest temporal resolution from the instruments on the mobile platform); this ensures that no collected data will be excluded from the final data file
- Process all available sets of GPS data and select the most complete version to be utilized as the main set of GPS data for the current survey
- Add metadata (route name, route version), define the “testing period” as when the vehicle left and returned to South Coast AQMD headquarters according to the GPS data, note whether a co-location occurred (if so, flag data collected at co-location sites, also based on GPS data)
- Calculate vehicle velocity and cumulative distance using the main set of GPS data
- Add data from the sampling duct (flow, temperature, and humidity), add interpolated data for these parameters
- Based on the flow rate in the duct, calculate the Reynolds number and flag periods of high turbulence
- Add humidity data from the PM reference instruments, add interpolated data for these two parameters, flag periods of high RH for the PM reference instruments
- Merge all pollutant data from all reference instruments (add interpolated versions of these data sets where appropriate)
- Merge all sample temperature and humidity data from all reference instruments, that has not been added already (add interpolated versions of these data sets where appropriate)
- Given that the data are logged to different files in different locations (e.g., on different laptops for instance), timestamps may not be perfectly synced, to correct for this a cross correlation function is applied to relative humidity signals to determine the lag (in seconds) that results in the highest correlation amongst these two signals, the data is then shifted accordingly and these shifts are noted in the “Log file”
- Generate an interactive, Leaflet map illustrating the path of the drive and with each point’s label containing the related timestamp
- Create Log file – with metadata and completeness data (as a percent, based on the maximum amount of data possible from a given instrument, based on test length and sampling frequency)
- Create Statistics file – with mean, median, minimum, maximum, 5th and 95th percentile values for each reference instrument
- Save the complete/merged data file, the Log file, the Statistics file, and the overview map

An example “Log file” and “Statistics file” are shown in Table 7 and Table 8. Figure 33 shows an example Leaflet map. The complete list of parameters in the comprehensive data file is found in Appendix E.

Table 7: Parameters available in "Log file" with example outputs.

Parameter	Response
Route Name	LA - SFV
Route Version	1
Test Start Time	2019-07-09 08:35:39 PDT
Test End Time	2019-07-09 17:00:55 PDT
Co-location (Y/N)	N
GPS Signal Used (res.)	GRIMM (6s)
Total Distance (km)	275.58
GPS Completeness (%)	16.65
T640 Completeness (%)	100.01
Magic CPC Completeness (%)	100
T400 O3 Completeness (%)	100.01
T500 NO2 Completeness (%)	100.01
T300 CO Completeness (%)	0
Licor CO2 Completeness (%)	0
PAX BC Completeness (%)	0
Inst. 1 lag (s)	28
Inst. 2 lag (s)	-51
Inst. 3 lag (s)	90

Table 8: Parameters available in "Statistics file" with example outputs.

	Mean	Median	Min	Max	Per 5 th	Per 95 th
T640 PM2.5	10.666	9.767	4.327	22.705	5.489	17.14
T640 PM10	16.711	15.259	6.139	34.839	8.299	29.39
GRIMM PM1.0	0	0	0	0	0	0
GRIMM PM2.5	0	0	0	0	0	0
GRIMM PM10	15.36	14.8	3.6	36.4	5.8	26.2
Magic CPC	NA	NA	NA	NA	NA	NA
PAX BC	NA	NA	NA	NA	NA	NA
T400 O3	23.776	25.1	0.8	57.5	4.4	41.9
T500 NO2	21.826	16.991	3.518	161.255	6.637	50.052
T300 CO	NA	NA	NA	NA	NA	NA
Licor CO2	573.644	542.778	411.514	1749.54	429.629	790.343

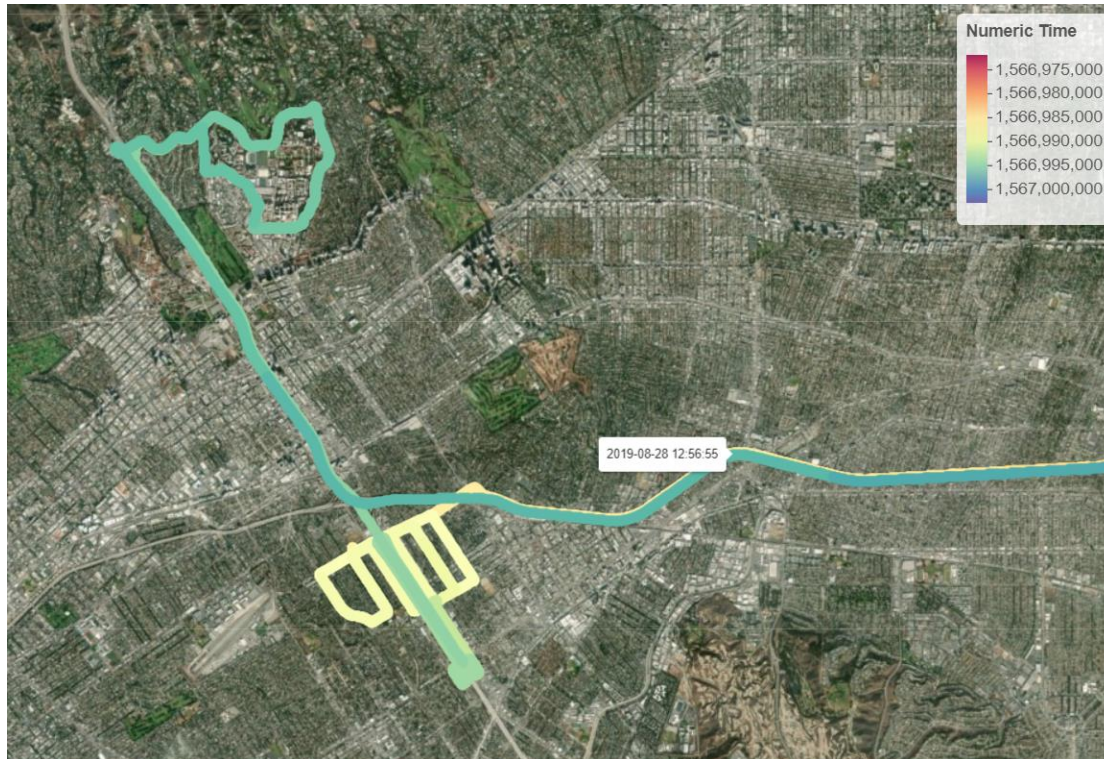

Figure 33: Example interactive Leaflet overview map.

4.4 Evaluation Parameter Calculations

4.4.1 Mean

The intra-unit arithmetic mean of all measurements, for each sensor unit, for each test drive, and for each test phase, reported by the LCS and the relevant reference analyzer(s) will be reported.

The intra-model grand mean across all units in the triplicate, for each test drive, and for test phase, will also be reported.

4.4.2 Absolute and Relative Standard Deviations

The intra-unit absolute standard deviation of each LCS's measurements, for each test drive, will be reported. These intra-unit absolute standard deviations will also be divided by the corresponding arithmetic means to report the relative standard deviations for each sensor unit, for each test drive.

The intra-model absolute standard deviation of the triplicate of LCS' measurements, for each test drive, will be reported. The intra-model absolute standard deviation for each test drive is calculated as the standard deviation of individual sensor means about the grand mean of the triplicate. These intra-model absolute standard deviations will also be divided by the corresponding arithmetic means to report the intra-model relative standard deviation across the triplicate, for each test drive.

4.4.3 Mean Bias, Mean Absolute, and Root Mean Square Errors

The intra-unit mean bias error (MBE) of LCS measurements, for each sensor unit, for each test drive, and for each test phase, will be calculated as:

$$MBE_j = \frac{1}{n} \sum_{i=1}^n (LCS_{j,i} - R_i)$$

where j is the individual LCS identifier, i is the time point during the test, $LCS_{j,i}$ is the jth LCS reading averaged across a common time base at the ith time point during the test, R_i is the reference analyzer reading averaged across a common time base at the ith time point during the test, and n is the number of time-matched data pairs during the test.

The intra-model MBE of the triplicate of LCS' measurements, for each test drive, will be calculated as:

$$\underline{MBE} = \frac{1}{n} \sum_{i=1}^n (\underline{LCS}_i - R_i)$$

Where i is the time point during the test, \underline{LCS}_i is the average reading of the triplicate of sensors averaged across a common time base at the ith time point during the test, R_i is the reference analyzer reading averaged across a common time base at the ith time point during the test, and n is the number of time-matched data pairs during the test.

The intra-unit and intra-model mean absolute errors (MAE) are calculated similarly to the intra-unit and intra-model MBE, respectively, except that the absolute value of the errors is used in the calculation.

Since MBE represents systematic errors and MAE represents random errors, the intra-unit and intra-model MBE/MAE ratios are also reported to suggest whether the errors from an LCS tend to be systematic (correctable) or random in nature.

The intra-unit root mean square error (RMSE) of LCS measurements, for each sensor unit, for each test drive, and for each test phase, will be calculated as:

$$RMSE_j = \sqrt{\frac{\sum_{i=1}^n (LCS_{j,i} - R_i)^2}{n}}$$

where j is the individual LCS identifier, i is the time point during the test, $LCS_{j,i}$ is the jth LCS reading averaged across a common time base at the ith time point during the test, R_i is the reference analyzer reading averaged across a common time base at the ith time point during the test, and n is the number of time-matched data pairs during the test.

The intra-model RMSE of the triplicate of LCS' measurements, for each test drive, will be calculated as:

$$\underline{RMSE} = \sqrt{\frac{\sum_{i=1}^n (\underline{LCS}_i - R_i)^2}{n}}$$

Where i is the time point during the test, \underline{LCS}_i is the average reading of the triplicate of sensors averaged across a common time base at the ith time point during the test, R_i is the reference analyzer reading averaged across a common time base at the ith time point during the test, and n is the number of time-matched data pairs during the test.

FINAL DRAFT

4.4.4 Range-Based Intra-Model Variability

The range-based intra-model variability (IMV) is related to how close the measurements from three units of the same sensor type are to each other. It is qualified through a set of descriptive statistical parameters, such as mean, median, and standard deviation. The intra-model variability, for each test drive, is then quantified as:

$$IMV (\%) = \frac{(\underline{LCS}_1, \underline{LCS}_2, \underline{LCS}_3) - (\underline{LCS}_1, \underline{LCS}_2, \underline{LCS}_3)}{\frac{\sum (\underline{LCS}_1, \underline{LCS}_2, \underline{LCS}_3)}{3}} \times 100\%$$

where \underline{LCS}_j is the average concentration value for the j^{th} test sensor unit of the triplicate for each test drive.

4.4.5 Data Recovery

Data recovery is calculated using a percentage ratio of the number of valid sensor data points over the total number of data points that should have been collected during the testing period (e.g. 4 hours of testing at 1-min time resolution results in up to 240 data points in total that should have been collected). Completeness is an important factor for producing reliable and representative data, as is indicated in the EPA guidelines for regulatory data collection. Data recovery is reported as follows:

$$Data Recovery (\%) = \frac{N_{valid\ data}}{N_{test\ period}} \times 100\%$$

where

$N_{valid\ data}$ is the number of valid sensor data points during the testing period and

$N_{test\ period}$ is the total number of data points that should have been collected for the testing period (from start to end) if no data was lost or invalidated

The data recovery can be calculated across each test drive and evaluation phase using all the data collected across an individual test drive or the entire testing phase, respectively.

4.4.6 LCS Lag Time

For each test drive, a record is kept of each LCS unit's time shift required to align with a reference analyzer measuring the same pollutant, using the time delay cross-correlation technique. These lag times are averaged across triplicates for Phase 1, Phase 2 clustered for each flow configuration, and Phase 3 for each sample inlet orientation. These averaged lag times represent the potential time shift that may need to be applied to a particular LCS model in a particular installation scenario to properly place the LCS measurements geographically.

4.4.7 LCS vs. Reference R^2 by Velocity

This parameter expresses the strength of the linear relationship between the measurements from the three sensors tested and the corresponding reference analyzer values. Data between reference analyzers and LCS are paired as follows:

- 3) The time averaging base for a given pollutant is determined by the data set that reports *less* frequently. For example, if the reference analyzer in question reports data every 3 seconds but

the LCS reports data every 60 seconds, then the time averaging will be based on the LCS reporting interval.

- 4) A data point from the *less* frequently reporting device is paired with the average of the data points from the *more* frequently reporting device that occur between the current and previous data timestamp of the *less* frequently reporting device. Continuing with the previous example, if an LCS data point has a timestamp at 7:01:05, and the previous LCS data point was 7:00:05, then the LCS data point at 7:01:05 will be paired with the average of the reference analyzer data that was reported between 7:00:05 and 7:01:05.
- 5) If there is clear information from an LCS manufacturer about a subsampling period within a reporting interval (when that subsampling occurs relative to the timestamp of a measurement, and how long that subsampling lasts), then only the reference analyzer data reported during LCS subsampling periods will be used.
- 6) If there is no clear information about any subsampling period within a reporting interval, then it is assumed that the LCS sampled during the entirety of the reporting interval.

The paired data set acquired from a test phase are entered into an *R* script and a best-fit linear regression curve is calculated along with the corresponding coefficient of determination (R^2), slope, and intercept values. An R^2 value approaching the value of 1 reflects a near perfect agreement between the sensors and reference analyzer readings, whereas a value of 0 indicates a complete lack of correlation.

Each of the three sensor unit datasets are treated separately, resulting in three R^2 values reported. Readings from the LCS triplicate may also be averaged at each time point to provide an intra-model R^2 value. Scatter plots are then created to visually present the correlation.

The paired reference analyzer and sensor data set acquired from each phase is entered into an *R* script. For a given installation scenario (e.g. inside a rooftop box with a top-to-back flow path), the data is segregated into speed bins, determined using vehicle GPS, of:

- 3-15 mph (walking/bicycle deployment);
- 15-30 mph (low speed vehicular deployment);
- 30-50 mph (medium speed vehicular deployment); and
- 50-80 mph (high speed vehicular deployment).

A best-fit linear regression curve of the data in each speed bin against the corresponding reference analyzer value is calculated along with the R^2 , slope, and intercept values. For each sensor unit, an orientation-speed bin matrix of correlations is presented to indicate the degradation, if any, in performance due to inlet orientation and velocity.

Table 9: Example velocity R^2 matrix for a single LCS model by testing phase. Data is artificial for example purposes.

Phase	3-15 mph	15-30 mph	30-50 mph	>50 mph
1 – Controlled Flow Duct	0.99	0.98	0.95	0.80
2A – Rooftop Enclosure, Front-to-Back	0.95	0.80	0.40	0.22
2B – Rooftop Enclosure, Top-to-Back	0.87	0.85	0.72	0.66
3A – Exposed Rooftop, Default Orientation	0.95	0.90	0.60	0.50
3B – Exposed Rooftop, Facing Forward	0.70	0.50	0.40	0.26
3C – Exposed Rooftop, Facing Backward	0.52	0.36	0.22	0.05

4.4.8 Phase 2 Optimal Location in an Enclosure

The paired reference analyzer and sensor data set acquired from the preliminary subphase of Phase 2, for a given flow configuration, is entered into an *R* script. For each sensor unit, a best-fit linear regression curve of the data against the corresponding reference analyzer value is calculated along with the R^2 , slope, and intercept values. The enclosure mounting location corresponding to the sensor unit with the best R^2 and slope closest to unity is identified for each enclosure flow path configuration. Using R^2 identifies the optimal enclosure location that reduces the influence of vehicle velocity and flow turbulence, while using another metric (such as accuracy) may result in identifying a location that masks a systematic bias due to miscalibration, sample flow effects, or drift.

5 Study Limitations

It must be recognized that the mobile platform evaluation of air quality sensors is limited in many aspects.

One of the major limitations of evaluation of LCS for mobile deployment is the sensor time resolution. Many sensor units output data at intervals of one minute or longer; at typical freeway speeds, this can mean that one data point is obtained at spatial resolutions of nearly 2 km. The time resolution of a sensor unit can suggest that its use in mobile monitoring may be more appropriate for low-speed deployment, such as neighborhood mapping, rather than regional mapping while traveling on high-speed roadways. It is expected that LCS developers will improve upon this limitation and put products in the marketplace that can report data at intervals as short as 1 second.

Although reference analyzers can be considered “real-time” due to their ability to output data at 1 Hz, the design of some instruments, especially those with an internal mixing cell, can introduce a signal smearing effect that can prolong the instrument’s response to a large concentration change.

Like field evaluations, the ambient environment is specific to its location and time of the year. The tested ambient environment can neither be controlled nor duplicated in respects including but not limited to: temperature, RH, pressure, external wind speeds, traffic volumes, traffic speeds, stop times, regional pollutant levels, particle compositions, and emissions from high-polluting vehicles and stationary sources. Therefore, the performance of the sensor under significantly different environmental conditions may not be duplicated. As a result, accuracy and precision of sensors is not quantifiable with the mobile platform.

The laboratory battery pack and power system place limitations on the duration of experiments. Therefore, the number of data points used to compare LCS to reference analyzers will be limited compared to a stationary field or laboratory evaluation.

The sheltering of the LCS inside a flow duct inside the vehicle or inside an enclosure outside the vehicle does not provide any indication of negative sensor performance due to sunlight exposure. Additionally, since LCS with fan-based sampling are mounted completely inside the sampling duct in Phase 1, their performance will be affected by temperature variations in the ambient air. LCS with pump-based sampling are mounted in the vehicle cabin and maintain a constant temperature with respect to the vehicle air conditioning system.

The limited testing duration using new sensor units does not allow for the evaluation of sensor degradation and baseline shifting.

Although evaluating LCS on the mobile platform subject the sensors to vibration, there does not yet exist a means to subject the sensors to known or controlled mechanical forces. Reproducible vibration testing may be better suited for an environmental chamber in the future.

The space constraints inside a passenger vehicle limit the mounting of most sensors in the sampling duct to a longitudinal triplicate arrangement, rather than a radially symmetric triplicate arrangement. Therefore, sensors may not experience similar pollutant concentrations and intra-model variability may be overestimated.

The need to maintain non-turbulent flow conditions inside the sampling duct *regardless* of vehicle speed favored the use of a transverse duct configuration, in which the sampling duct inlet flow is perpendicular to the direction of motion. Because of this anisoaxial sampling condition, sampling efficiencies are low for

particles above 2.5 μm in diameter, especially at high vehicle speeds. Thus, the PM_{10} concentrations reported by both reference analyzers and LCS will likely be vastly underestimated. Further work is needed to improve the sampling system for PM_{10} . Currently, PM_{10} is not a pollutant that will be evaluated on the mobile platform.

The configurations of the air flow path, LCS locations, and sensor inlet orientations explored in Phase 2 and Phase 3 of testing do not encompass all possible, or even optimal, possibilities involving the use of a rooftop enclosure box or fully-exposed rooftop mounting for sampling. The results from Phase 2 and Phase 3 testing can only provide general guidance on enclosure design and sensor positioning to provide better quality data from LCS in a mobile application.

Finally, the constraints of the Google Street View vehicle do not allow for the sampling duct inlet, rooftop enclosure box, or LCS directly mounted on the roof to be at a higher elevation above ground, nor can an anemometer be installed. Ideally wind measurements and air samples would be obtained at a height of at least 1.5 times the height of the urban canopy layer [16] (the mean height of buildings and trees in an urban area), where the wind speed profile is logarithmic in nature and the air pollutant concentrations would be more representative of ambient conditions rather than localized traffic exhaust. In many parts of SCAB, the urban canopy layer may be approximately 30 feet, meaning that measurement would ideally occur at a height of 45 feet above ground. Therefore, pollutant concentrations may be more representative of traffic emissions and road dust re-suspension. Wind direction and wind speed, if necessary components for the data analysis, are assumed to be equal to concurrent measurements from the nearest AMS.

6 References

- [1] A. Polidori, V. Papapostolou, B. Feenstra and H. Zhang, "Field Evaluation of Low-Cost Air Quality Sensors: Field Seupt and Testing Protocol," January 2017. [Online]. Available: <http://www.aqmd.gov/docs/default-source/aq-spec/protocols/sensors-field-testing-protocol.pdf?sfvrsn=0>. [Accessed 12 September 2019].
- [2] B. Feenstra, V. Papapostolou, S. Hasheminassab, H. Zhang, B. Der Boghossian, D. Cocker and A. Polidori, "Performance evaluation of twelve low-cost PM2.5 sensors at an ambient air monitoring site," *Atmospheric Environment*, vol. 216, p. 116946, 2019.
- [3] V. Papapostolou, H. Zhang, B. Feenstra and A. Polidori, "Development of an environmental chamber for evaluating the performance of low-cost air quality sensors under controlled conditions," *Atmospheric Environment*, vol. 171, pp. 82-90, 2017.
- [4] R. D. Cadle, *The Measurement of Airborne Particles*, New York: John Wiley & Sons, 1975.
- [5] W. C. Hinds, *Aerosol Technology: Properties, Behavior, and Measurement of Airborne Particles*, New York: John Wiley & Sons, 1982.
- [6] P. A. Baron and K. Willeke, *Aerosol Measurement: Principles, Techniques, and Applications*, New York: John Wiley & Sons, 2001.
- [7] P. Baron, "Aerosol calculator," available from pbaron@cdc.gov, 2001.
- [8] S.-L. Von Der Weiden, F. Drewnick and S. Borrmann, "Atmospheric Measurement Techniques Particle Loss Calculator-a new software tool for the assessment of the performance of aerosol inlet systems," 2009.
- [9] A. Polidori, V. Papapostolou and H. Zhang, "Laboratory Evaluation of Low-Cost Air Quality Sensors," 2016.
- [10] M. Rhudy, "Time Alignment Techniques for Experimental Sensor Data," *International Journal of Computer Science & Engineering Survey*, vol. 5, no. 2, pp. 1-14, 2014.
- [11] R Core Team, "R: A language and environment for statistical computing," 2019. [Online]. Available: <http://www.R-project.org/>.
- [12] P. J. Brockwell, R. A. Davis and S. E. Fienberg, *Time Series: Theory and Methods: Theory and Methods*, New York: Springer Science & Business Media, 1991.
- [13] V. W. Chang, L. M. Hildemann and C. H. Chang, "Wind tunnel measurements of the dilution of tailpipe emissions downstream of a car, a light-duty truck, and a heavy-duty truck tractor head," *Journal of the Air and Waste Management Association*, 2009.

- [14] S. T. Martin, "Phase Transitions of Aqueous Atmospheric Particles," *Chemical Reviews*, vol. 100, no. 9, pp. 3403-3454, 2000.
- [15] J. H. Seinfeld and S. N. Pandis, *Atmospheric Chemistry and Physics: From air pollution to climate change*, 2nd ed., New York: John Wiley & Sons, 2006.
- [16] T. R. Oke, "World Meteorological Organization Instruments and Observing Methods Report No. 81: Initial Guidance to Obtain Representative Meteorological Observations at Urban Sites," 2006. [Online]. Available: <http://www.wmo.int/pages/prog/www/IMOP/publications/IOM-81/IOM-81-UrbanMetObs.pdf>. [Accessed 7 June 2019].
- [17] M. Geller, S. Biswas and C. Sioutas, "Determination of Particle Effective Density in Urban Environments with a Differential Mobility Analyzer and Aerosol Particle Mass Analyzer," *Aerosol Science and Technology*, vol. 40, pp. 709-723, 2006.
- [18] H. Schade, E. Kunz, F. Kameier and C. O. Paschereit, *Strömungslehre*, Walter de Gruyter, 1989.
- [19] A. Polidori, V. Papapostolou, B. Feenstra and H. Zhang, "Field Evaluation of Low-Cost Air Quality Sensors," 2017.

FINAL DRAFT**Appendix A – Reference Methods**

Federal Reference Method (FRM): A FRM is an "EPA approved" method, sampler or analyzer that utilizes the measurement principles and calibration procedures specified in the Code of Federal Regulations (40 CFR Part 50).

Federal Equivalent Method (FEM): A FEM is an ambient air monitoring method that has been designated by EPA as an equivalent method under 40 CFR Part 53.

To be considered as a viable FRM/FEM candidate, a potential measurement technique must:

- Provide accurate and reliable measurements.
- Be relatively free of significant interference from gases or other agents that may occur in ambient air.
- Provide continuous or nearly continuous measurements in near real-time.
- Be commercially available at modest or reasonable cost.
- Be reasonably easy and convenient to operate by typical air monitoring personnel to produce measurements of good accuracy and precision.
- Be reasonably and routinely field-deployable for use as a quality assurance reference in monitoring networks.

Reference instrument:

An analyzer is calibrated (or re-calibrated):

- Upon initial installation.
 - Following physical relocation.
 - After any repairs or service that might affect its calibration.
 - Following an interruption in operation of more than a few days.
 - Upon any indication of analyzer malfunction or change in calibration.
 - At some routine interval (see below).
- a) Reference gas analyzers are calibrated using certified gas cylinders every 6 months, and span-checked before the start of testing a new sensor
 - b) The Teledyne T640 particulate analyzer is regularly maintained as indicated by the instrument manufacturer. Teledyne T640 particulate analyzer is sent back to the manufacturer for re-calibration every 12 months

It should be noted that while some of the gas and particle analyzers on the mobile platform have received US EPA FRM/FEM designations, their use in a non-stationary deployment application is among the operating conditions that are not consistent with FRM/FEM requirements. For example, there may be different averaging timescales used to attain FRM/FEM designation by an instrument (daily and annualized averages), while in this protocol the highest time frequency readings are used because 1) low-cost sensors typically report values in intervals of ~1 minute and 2) high time resolution measurements are critical for mobile applications since a large distance can be covered by the mobile platform in a few seconds. Nonetheless, FRM/FEM reference analyzers are used on the mobile platform because these instruments have an established accuracy and history of performance through their FRM/FEM designations, making them good candidates to use on a novel platform.

Appendix B – Modeling Results for the Sampling Duct and Isokinetic PM Probe

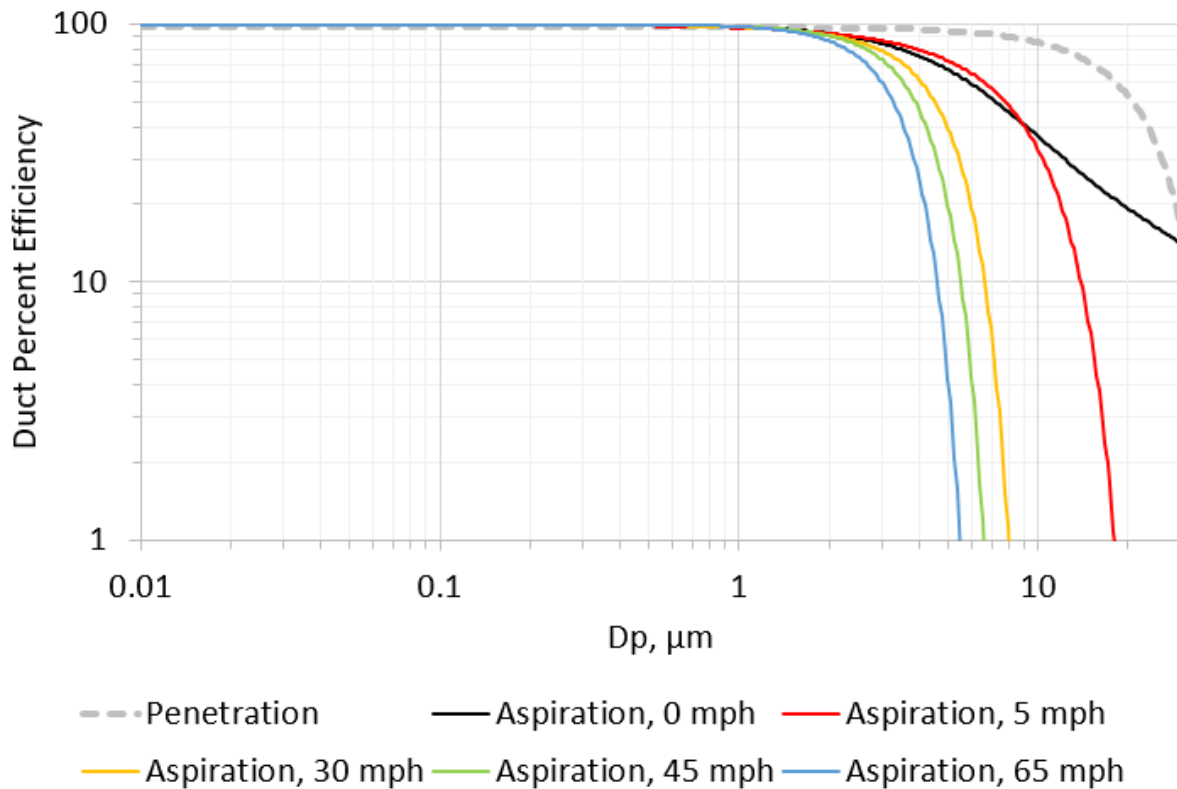

Figure 34: Modeled particle efficiencies through the sampling duct leading up to the isokinetic PM probe inlet. Note that only the penetration efficiency and portions of the 0 mph aspiration efficiency case returned values based on parameter inputs that are within the range of applicability for equations used to model efficiencies; results for all other velocities are likely overestimates of efficiency. In addition, although the duct inlet diameter is 95.25 mm, an artificial duct inlet diameter of 22 mm was used as an input value for the Particle Loss Calculator to keep the ratio of the wind velocity to probe velocity $U_0/U \leq 2$ to maintain validity of the aspiration efficiency equation for anisoaxial sampling [8] and remove false efficiency results exceeding a value of 100%. Particle density was assumed to be 1.5 g/cm^3 as an upper bound based on findings from [17].

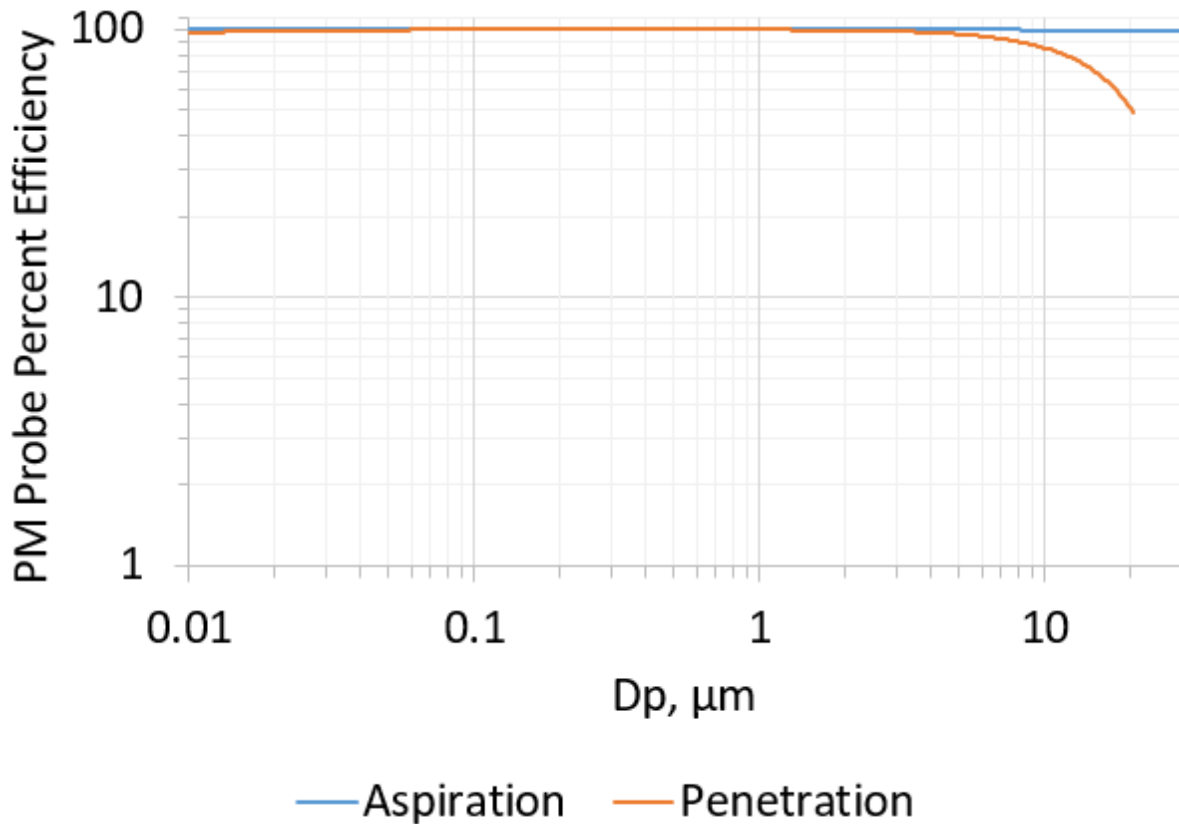

Figure 35: Modeled particle efficiencies through the isokinetic PM probe inlet. Note that parameter inputs that are outside the range of applicability for equations used to model efficiencies; results are likely overestimates of efficiency. Particle density was assumed to be 1.5 g/cm^3 as an upper bound based on findings from [17].

Appendix C – Test Log Forms

Date _____ Test Number _____ Vehicle _____
 Route _____ Odometer Start _____
 Driver _____ Odometer End _____
 Passenger _____ Vehicle SOC Start _____ End _____

Weather Conditions _____ AC AC Temperature ____ °F

Goal for Test _____

Exhaust Tube Outside
 Probes Connected
 Silica Gel Dryers Blue

LCS Duct Fan
 MAGIC Water Reservoir Filled
 DMT PAX Pre-Test Manual Zero at _____

Instruments

430	PAX	T300	T500U	MAGIC	T640	AtlasLink	WindMaster
O ₃	BC	CO	NO ₂	PC	PM	GPS	PM
<input type="checkbox"/>	<input type="checkbox"/>	<input type="checkbox"/>	<input type="checkbox"/>	<input type="checkbox"/>	<input type="checkbox"/>	<input type="checkbox"/>	<input type="checkbox"/>

Equipment

Dell	Alcatel	Rexing
Laptop	Wi-Fi	Dash Cam
<input type="checkbox"/>	<input type="checkbox"/>	<input type="checkbox"/>

Low-Cost Sensors

AQL	PA-II	POM
S/N:	S/N:	S/N:
O ₃ , NO ₂	PM	O ₃
<input type="checkbox"/>	<input type="checkbox"/>	<input type="checkbox"/>

Time (PST/PDT) _____

Instruments On _____ Station Departure Time _____
 Low-Cost Sensors On _____ Drive End _____
 Terminal Logging On _____ Terminal Logging Off _____
 Drive Start _____ Low-Cost Sensors Off _____
 Station Arrival Time _____ Instruments Off _____

Notes _____

Version 1.7

Figure 36: Example test log form for mobile sensor evaluation. Form is continuously updated and subject to change.

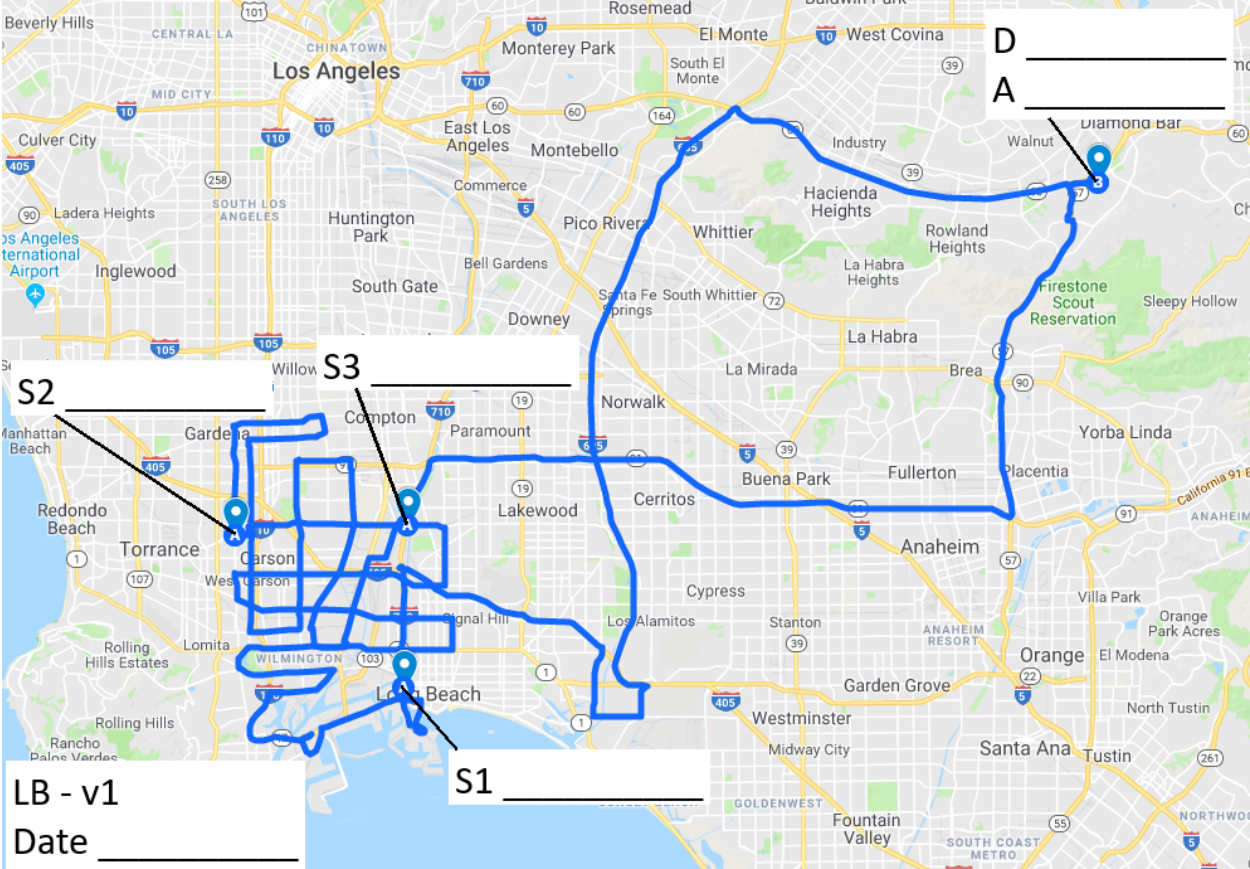

Figure 37: Example driver log map form for mobile sensor evaluation for a route. Form is continuously updated and subject to change.

Appendix D – Data Visualization

The ability to easily visualize data from the mobile platform facilitates quicker assessments of routes, faster troubleshooting of any issues with the instruments, and initial analysis of the data. Two data visualization tools were created by AQ-SPEC staff; one with the ability to visualize data in real-time during a drive and the other designed for quickly processing and viewing historical data. This was achieved by leveraging the open-source Shiny App (<http://shiny.rstudio.com/>) and Leaflet (<https://rstudio.github.io/leaflet/>) packages built for use with RStudio. Included in both visualization tools is the ability to plot data on an interactive hypertext markup language (HTML) map, as well as assign color-gradients to the pollutant concentration. Furthermore, the user can choose to view the map with data plotted chronologically or sorted by concentration. The sorting function prevents high concentration points from being obscured by low concentration points.

Both tools also include the ability to explore time series of the data. Another option available to the user, for all plots and maps, is to adjust the duration of the drive shown. The real-time tool allows the user to view the entire drive or select just the most recent hour, while the historic tool allows the user to select start and end times. In addition to the maps and time series, the historic tool also includes a scatterplot function allowing the user to compare two pollutants, as well as the ability to add data from the LCS mounted in the sampling duct. Lastly, the historic version of the tool facilitates a first look at the agreement between the LCS and corresponding reference instruments.

The purpose of this tool is to serve as a first step in analysis of mobile platform data, working with the most complete version of the data with minimal processing. This tool is intended to serve a jump-off point for more in-depth analysis of the data by quickly revealing interesting trends or events observed during the mobile survey. Figure 38 through Figure 43 show example visualizations provided by the tools.

FINAL DRAFT

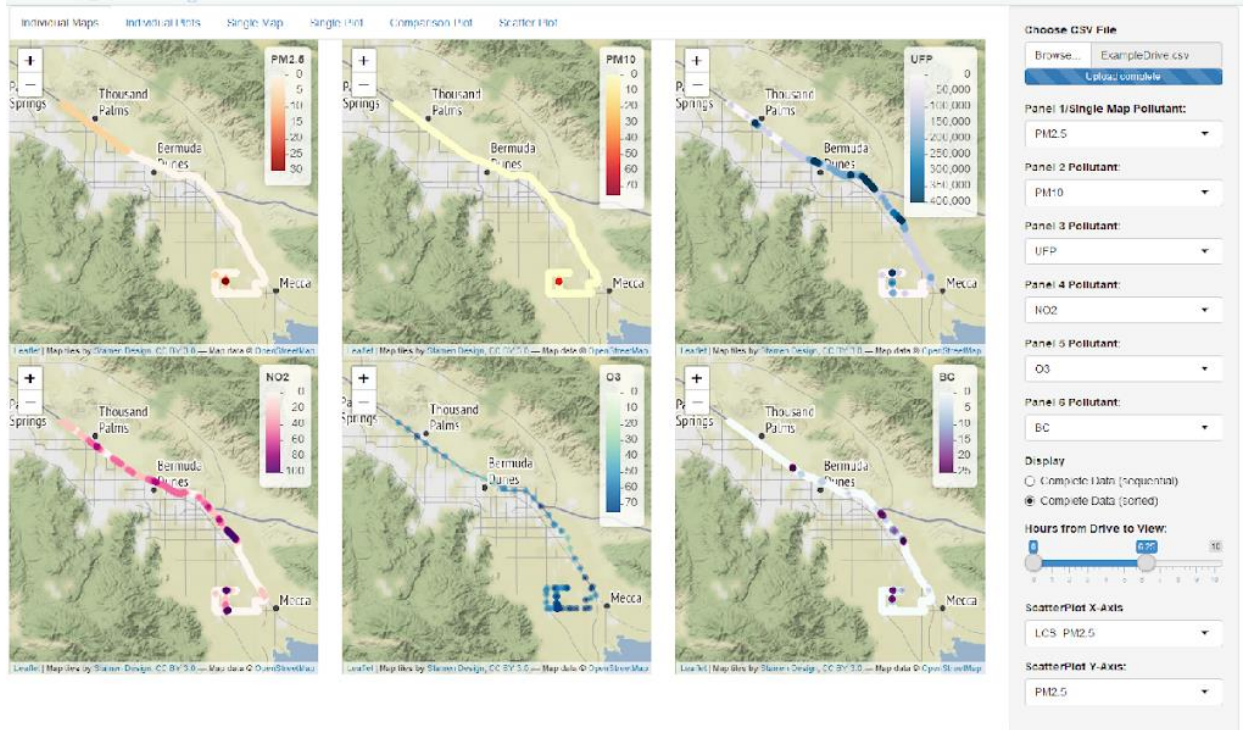

Figure 38: Data visualization tool displaying individual maps allowing for comparison of multiple pollutants.

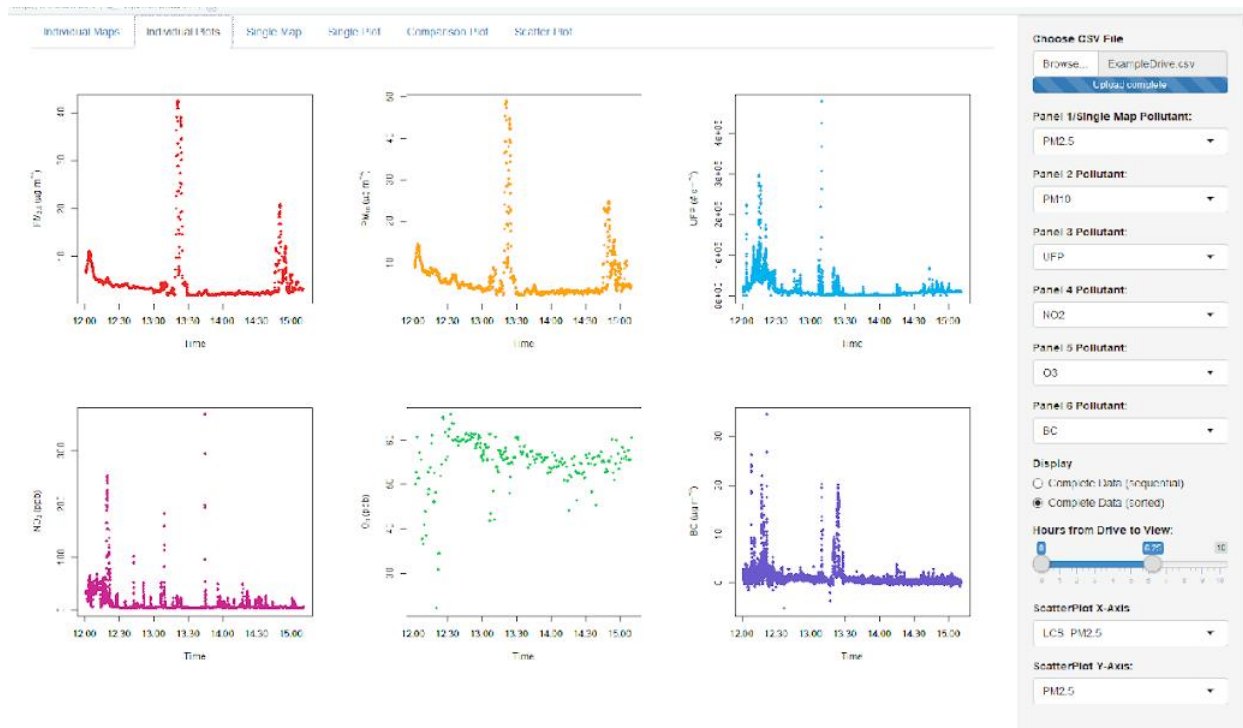

Figure 39: Data visualization tool displaying individual timeseries allowing for comparison of multiple pollutants.

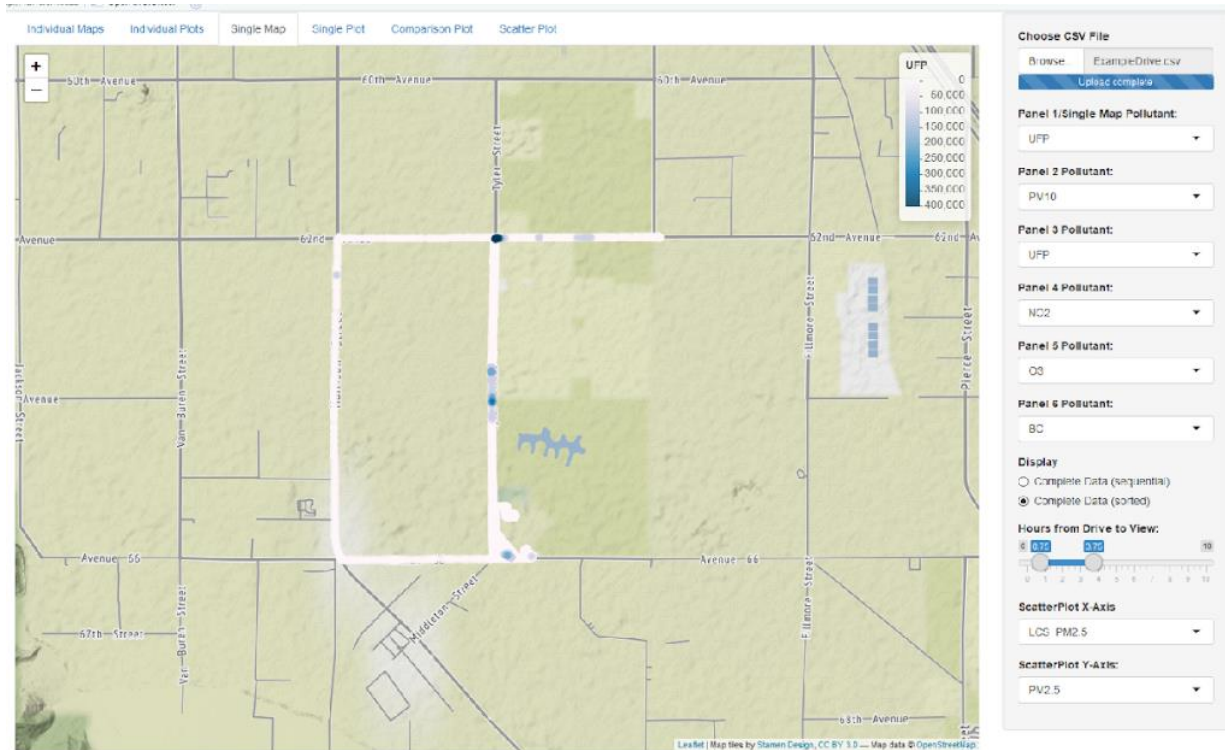

Figure 40: Data visualization tool displaying map for a single pollutant to allow for closer inspection.

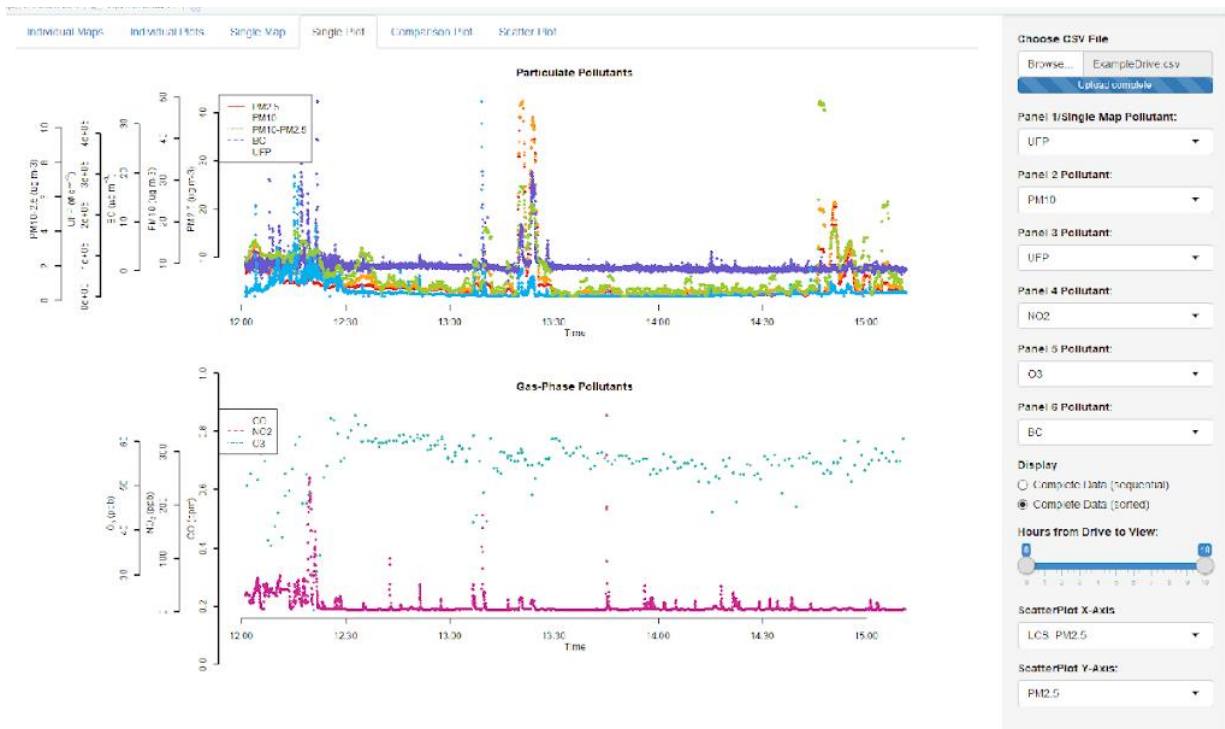

Figure 41: Data visualization tool displaying overlaid time-series from reference instruments.

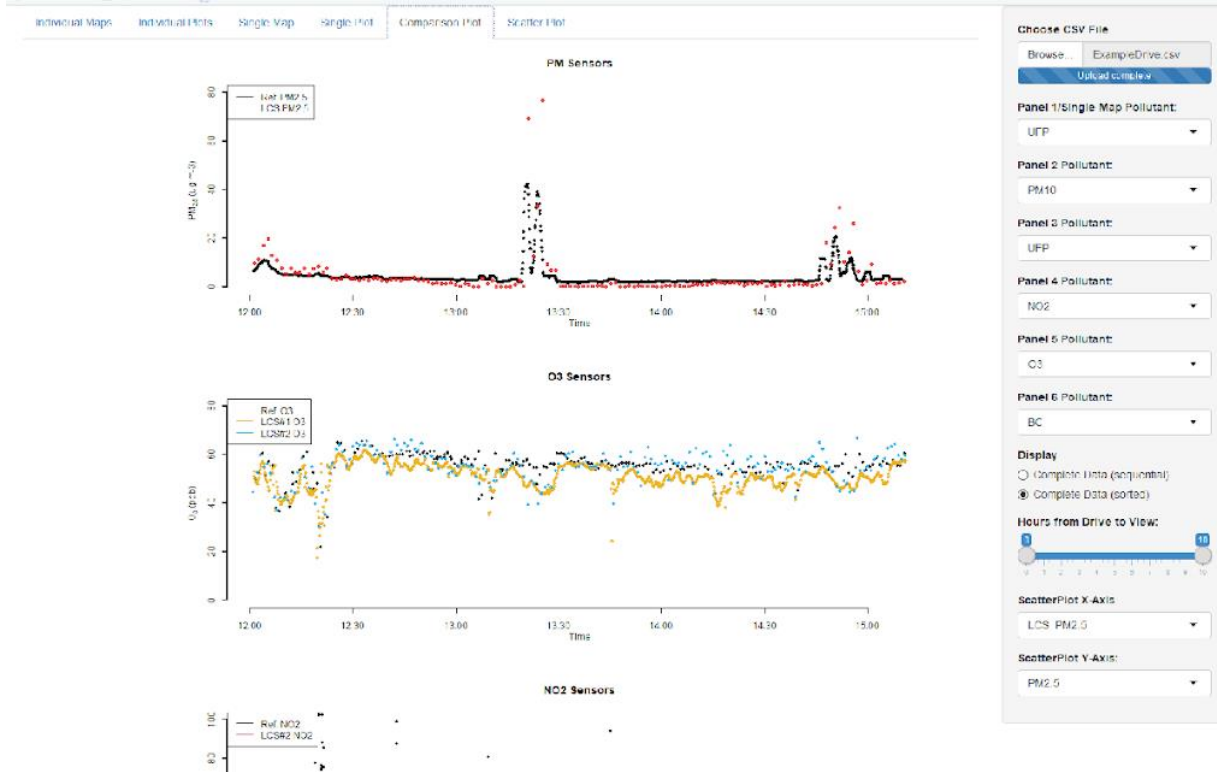

Figure 42: Data visualization tool displaying overlaid time-series from LCS and corresponding reference instruments.

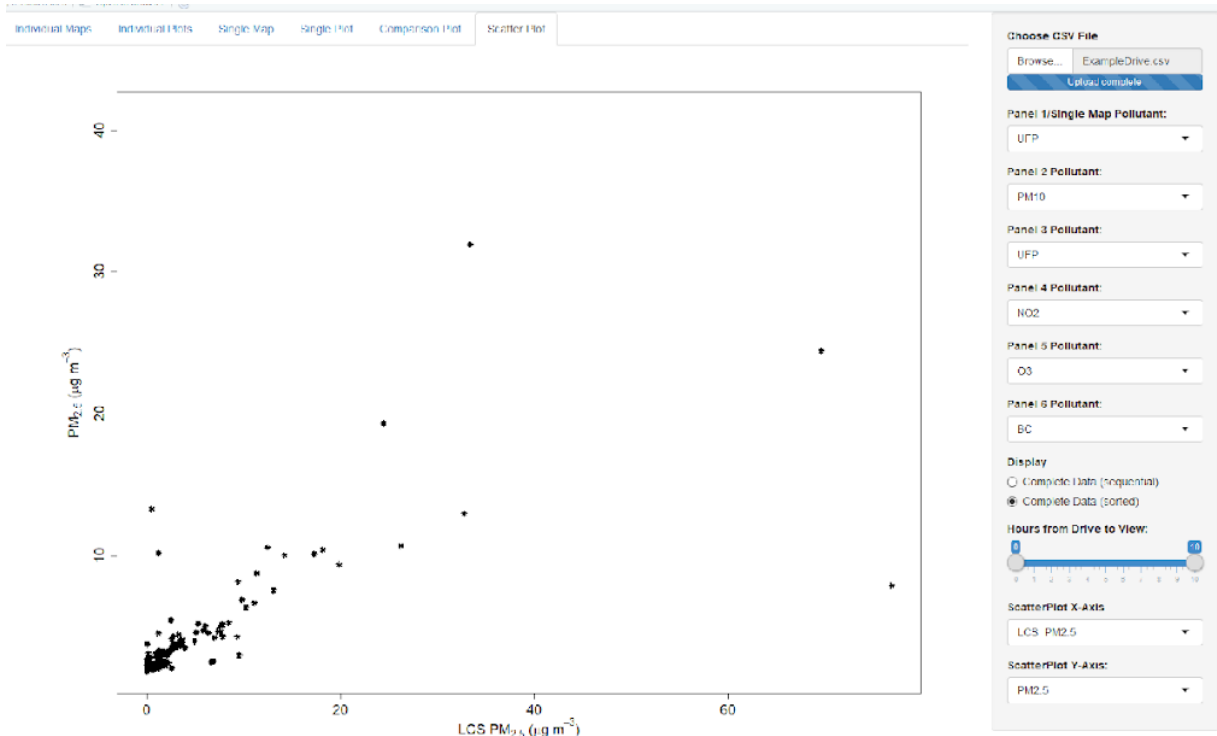

Figure 43: Data visualization tool displaying scatterplot feature allowing for preliminary assessments of correlations.

Data Flow for Viewing Historic Mobile Platform Data

At the end of a drive, the complete data from the reference instruments and GPS logged to the Agilaire 8872 data logger is exported to comma-separated values (CSV) files. There is one CSV file for 1-second resolution data, and another CSV file for 3-second resolution data. Additionally, data for the duration of the drive from the LCS is obtained. Both reference instrument and LCS data files are saved to a shared drive.

The 1-second and 3-second reference data files are merged, retaining all data. Each data point from the 3-second file is matched to the corresponding point in the 1-second data file and the gap seconds are filled in with NaNs. This process is then repeated for the LCS data files, again with each data point being matched to the corresponding point in the one-second reference data file.

If any GPS data is missing at the 1-second resolution, linear interpolation is used to fill in the missing points. At this stage additional corrections are also applied as needed, such as individual reference instrument delay times.

This merged and processed file is then saved as a CSV for use with the Shiny App.

The processed file may be loaded directly into the Shiny App and the App may be used to explore the mobile data.

Data Flow for Viewing Real-Time Mobile Platform Data

Data from the Agilaire 8872 data logger is transmitted to a shared drive. This procedure is still under development.

Utilizing reactive functions, the Shiny app continually updates the data available in the app as it becomes available. New data is appended to existing data and necessary re-processing is conducted (e.g., merging 1- and 3-second data streams and correcting for individual instrument time lags).

The most up-to-date real-time data is plotted in the app, which updates the display automatically. Furthermore, the maps in the app select the most recent GPS point as the center and thus track the vehicle's position in real-time.

FINAL DRAFT**Appendix E - Post-Processing Data File Parameters**

Column headers for the complete, merged data file:

"DateTime_PST" – based on the minimum and maximum times observed in the available data files

"Route" – route name (entered by user)

"RouteVer" – route version (entered by user)

"SectorID" – sector of the test route the vehicle is currently located in (#)

"TestPeriod" – (0/1) defined by whether the vehicle has left AQMD headquarters

"CoLocatInd" – (0, 1, 2, 3, 4) indices correspond to either no co-location (0) or a co-location occurring at one of the 4 possible regulatory monitoring sites (1, 2, 3, 4)

"Lat" – Latitude (main), from most complete set of GPS data collected

"Long" – Longitude (main), from most complete set of GPS data collected

"VehicleVel_mps" – vehicle velocity calculated based on GPS and timestamp data (meters per second)

"CDist_m" – cumulative distance traveled (meters)

"DuctTemp_C" – temperature in the sampling duct (3s sampling frequency) (deg. C)

"DuctTempInt_C" – temperature values linearly interpolated to 1 second resolution

"DuctRH_per" – percent relative humidity in the sampling duct (3s sampling frequency)

"DuctRHInt_per" – relative humidity values linearly interpolated to 1 second resolution

"DuctVel_ftpm" – velocity in the sampling duct (ft per minute)

"ReyNum" – Reynolds number, calculated based on the velocity in the duct

"ReyNumAve" – 1-hour rolling average of the Reynolds number

"DuctTurbFlag" – flag (0/1), 1 – for ReyNumAve values greater than 4000

"T640RH_per" – percent relative humidity for the T640 instrument (60s sampling frequency)

"T640RHInt_per" – relative humidity values linearly interpolated to 1 second resolution

"T640RHFlag" – flag (0/1), 1 for humidity values greater than 50%

"GrimmRH_per" – percent relative humidity for the GRIMM instrument (6s sampling frequency)

FINAL DRAFT

"GrimmRHInt_per" – relative humidity values linearly interpolated to 1 second resolution

"GrimmRHFlag" – flag (0/1), 1 for humidity values greater than 50%

"T640PM25_ug/m3" – PM2.5 data from the T640 (3s sampling frequency)

"T640PM25Int_ug/m3" – PM2.5 values linearly interpolated to 1 second resolution

"T640PM10_ug/m3" – PM10 data from the T640 (3s sampling frequency)

"T640PM10Int_ug/m3" – PM10 values linearly interpolated to 1 second resolution

"GrimmPM01_ug/m3" – PM1.0 data from the GRIMM (6s sampling frequency)

"GrimmPM01Int_ug/m3" – PM1.0 values linearly interpolated to 1 second resolution

"GrimmPM25_ug/m3" – PM2.5 data from the GRIMM (6s sampling frequency)

"GrimmPM25Int_ug/m3" – PM2.5 values linearly interpolated to 1 second resolution

"GrimmPM10_ug/m3" – PM10 data from the GRIMM (6s sampling frequency)

"GrimmPM10Int_ug/m3" – PM10 values linearly interpolated to 1 second resolution

"MagicConc_num/cm3" – ultrafine particle count data from the Magic CPC (1s sampling frequency)

"PAXBC_ug/m3" – black carbon particle count data from the PAX (1s sampling frequency)

"T400O3_ppb" – ozone data from the Teledyne T400 (3s sampling frequency)

"T400O3Int_ppb" – ozone values linearly interpolated to 1 second resolution

"T500NO2_ppb" – nitrogen dioxide data from the Teledyne T500 (3s sampling frequency)

"T500NO2Int_ppb" – nitrogen dioxide values linearly interpolated to 1 second resolution

"T300CO_ppm" – carbon monoxide data from the Teledyne T300 (3s sampling frequency)

"T300COInt_ppm" – carbon monoxide values linearly interpolated to 1 second resolution

"LicorCO2_ppm" – carbon dioxide data from the Licor-850 (1s sampling frequency)

"POMGPSLat" – GPS data available from the POM (10s sampling frequency)

"POMGPSLong" – GPS data available from the POM (10s sampling frequency)

"GrimmGPSLat" – GPS data available from the GRIMM (6s sampling frequency)

"GrimmGPSLong" – GPS data available from the GRIMM (6s sampling frequency)

FINAL DRAFT

"EmlidGPSLat" – GPS data available from the Emlid (1s sampling frequency)

"EmlidGPSLong" – GPS data available from the Emlid (1s sampling frequency)

"RecGPSLat" – GPS data available from the GlobalSat SiRF Star GPS Receiver (1s sampling frequency)

"RecGPSLong" – GPS data available from the GlobalSat SiRF Star GPS Receiver (1s sampling frequency)

"NearestRefSite" – nearest regulatory monitoring site (accessed via PWFSL R-package)

"RefPM25_ug/m3" – corresponding hourly average for PM2.5 from nearest regulatory monitoring site (accessed via PWFSL R-package)

"RefPM10_ug/m3" – corresponding hourly average for PM10 from nearest regulatory monitoring site (accessed via PWFSL R-package)

"RefO3_ppb" – corresponding hourly average for O3 from nearest regulatory monitoring site (accessed via PWFSL R-package)

"RefNO2_ppb" – corresponding hourly average for NO2 from nearest regulatory monitoring site (accessed via PWFSL R-package)

"RefCO_ppm" – corresponding hourly average for CO from nearest regulatory monitoring site (accessed via PWFSL R-package)

"QAQCFlag1" – open QA/QC channel (currently empty)

"QAQCFlag2" – open QA/QC channel (currently empty)

"QAQCFlag3" – open QA/QC channel (currently empty)