



South Coast Air Quality Management District



21865 Copley Drive, Diamond Bar, CA 91765-4178
(909) 396-2000 • www.aqmd.gov

December 5, 2014

County Clerk, Brandy Evans
County of Los Angeles
12400 E. Imperial Hwy, Room 2001
Norwalk, CA 90650

Dear Ms. Evans:

Re: Notice of Determination – Final Mitigated Negative Declaration For The Toxic Air Contaminant Reduction for Compliance with SCAQMD Rules 1420.1 and 1402 at the Exide Technologies Facility in Vernon, CA - SCH No. 2014101040

Enclosed are two copies of a Notice of Determination (NOD) for the above project, which is located in Los Angeles County. The California Environmental Quality Act (CEQA) document for the proposed project was certified on December 5, 2014. Please record and post according to the provisions of CEQA.

The Notice of Determination contained herein is for a permit to construct for which the SCAQMD has prepared the Final Mitigated Negative Declaration (MND). The SCAQMD has determined that the project, for which the Final MND was prepared, will have no impact on wildlife and the habitat upon which it depends. Therefore, the project is exempt from the Department of Fish and Game filing fee pursuant to Fish and Game Code 711.4(c), Title 14, CCR. A no effect determination form is also included for this project as required pursuant to Section 753.5 (c), Title 14, CCR.

Please confirm receipt of one copy and return to the undersigned. Self addressed envelopes have been provided for your convenience. If you have any questions, you can call me at (909) 396-2706 or Cynthia Carter at (909) 396-2431.

Sincerely,

Michael Krause
Program Supervisor, CEQA

NOTICE OF DETERMINATION

To: County Clerk, Brandy Evans
County of Los Angeles
12400 E. Imperial Hwy., Room 2001
Norwalk, California 90650

From: South Coast Air Quality Management District
21865 Copley Drive
Diamond Bar, California 91765

SUBJECT: FILING OF NOTICE OF DETERMINATION IN COMPLIANCE WITH SECTION 21152 OF THE PUBLIC RESOURCES CODE

Project Title: Final Mitigated Negative Declaration for the Toxic Air Contaminant Reduction for Compliance with SCAQMD Rules 1420.1 and 1402 at the Exide Technologies Facility

SCH Number: 2014101040 **Date Certified:** December 5, 2014

Contact Person: Michael Krause **Telephone Number:** (909) 396 - 2706

Project Location: 2700 South Indiana Street, Vernon, CA 90058

Project Description: Exide Technologies is proposing a project to reduce toxic emissions of arsenic, benzene and 1,3-butadiene to comply with the recent amendments made to SCAQMD Rule 1420.1 - Emission Standards for Lead and Other Toxic Air Contaminants from Large Lead-Acid Battery Recycling Facilities, as well as to assure compliance with requirements in SCAQMD Rule 1402 - Control of Toxic Air Contaminants from Existing Sources including the Proposed Revised Final Risk Reduction Plan. Compliance will be accomplished with the installation of air pollution control equipment including two regenerative thermal oxidizers, two scrubbers, and dust collectors.

This is to advise that the *South Coast Air Quality Management District* has approved the above described project and has made the following determinations regarding the above described project:

1. The proposed project will not have a significant adverse impact on the environment.
2. The Final Mitigated Negative Declaration was prepared for this project pursuant to the provisions of CEQA.
3. Mitigation measures were made a condition of the approval of this project.
4. A mitigation reporting or monitoring plan under PRC Section 21081.6 was adopted for this project.
5. A Statement of Overriding Considerations was not adopted for this project because the potential environmental impacts were not significant.
6. Findings were not made pursuant to the provisions of CEQA.

This is to certify that the Final Mitigated Negative Declaration, supporting documentation, and record of project approval may be examined at: SCAQMD, 21865 Copley Drive, Diamond Bar, CA 91765

Date Received for Filing

Signature: 

Barry R. Wallerstein, D. Env.
Executive Officer

NOTICE OF DETERMINATION

To: County Clerk, Brandy Evans
County of Los Angeles
12400 E. Imperial Hwy., Room 2001
Norwalk, California 90650

From: South Coast Air Quality Management District
21865 Copley Drive
Diamond Bar, California 91765

SUBJECT: FILING OF NOTICE OF DETERMINATION IN COMPLIANCE WITH SECTION 21152 OF THE PUBLIC RESOURCES CODE

Project Title: Final Mitigated Negative Declaration for the Toxic Air Contaminant Reduction for Compliance with SCAQMD Rules 1420.1 and 1402 at the Exide Technologies Facility

SCH Number: 2014101040 **Date Certified:** December 5, 2014

Contact Person: Michael Krause **Telephone Number:** (909) 396 - 2706

Project Location: 2700 South Indiana Street, Vernon, CA 90058

Project Description: Exide Technologies is proposing a project to reduce toxic emissions of arsenic, benzene and 1,3-butadiene to comply with the recent amendments made to SCAQMD Rule 1420.1 - Emission Standards for Lead and Other Toxic Air Contaminants from Large Lead-Acid Battery Recycling Facilities, as well as to assure compliance with requirements in SCAQMD Rule 1402 - Control of Toxic Air Contaminants from Existing Sources including the Proposed Revised Final Risk Reduction Plan. Compliance will be accomplished with the installation of air pollution control equipment including two regenerative thermal oxidizers, two scrubbers, and dust collectors.

This is to advise that the *South Coast Air Quality Management District* has approved the above described project and has made the following determinations regarding the above described project:

1. The proposed project will not have a significant adverse impact on the environment.
2. The Final Mitigated Negative Declaration was prepared for this project pursuant to the provisions of CEQA.
3. Mitigation measures were made a condition of the approval of this project.
4. A mitigation reporting or monitoring plan under PRC Section 21081.6 was adopted for this project.
5. A Statement of Overriding Considerations was not adopted for this project because the potential environmental impacts were not significant.
6. Findings were not made pursuant to the provisions of CEQA.

This is to certify that the Final Mitigated Negative Declaration, supporting documentation, and record of project approval may be examined at: SCAQMD, 21865 Copley Drive, Diamond Bar, CA 91765

Date Received for Filing

Signature: 

Barry R. Wallerstein, D. Env.
Executive Officer

**PROPOSED EXIDE TOXIC AIR CONTAMINANTS REDUCTION
PROJECT**

**ATTACHMENT 1 - MITIGATION MONITORING AND
REPORTING PLAN**

Introduction

Summary of the Proposed Project

Significant Adverse Impacts which Can Be Reduced Below a Significant Level

Significant Adverse Impacts which Cannot Be Reduced Below a Significant Level

Mitigation Monitoring and Reporting Plan

INTRODUCTION

Exide Technologies is proposing to reduce toxic emissions of arsenic, benzene and 1,3-butadiene to comply with the recent amendments made to SCAQMD Rule 1420.1 - Emission Standards for Lead and Other Toxic Air Contaminants from Large Lead-Acid Battery Recycling Facilities, as well as to assure compliance with requirements in SCAQMD Rule 1402 - Control of Toxic Air Contaminants from Existing Sources, including the Revised Final Risk Reduction Plan. This will be accomplished by ensuring exhaust gas streams containing high levels of arsenic emissions are vented to appropriate air pollution control systems capable of controlling arsenic emissions which exist in gaseous or unfilterable form. The proposed project will also control gas streams containing gaseous organic air contaminants, carbon monoxide, and oxides of sulfur which previously escaped control because they were vented only to dry filter media or were emitted inside the building enclosure due to a lack of sufficient negative pressure in the reverberatory and blast furnaces. These modifications constitute a "project" as defined by CEQA (California Public Resources Code [PRC] §21000 et seq.). Since the SCAQMD has primary approval authority over the proposed project, SCAQMD is the appropriate lead agency under CEQA.

Pursuant to CEQA Guidelines §15070, the SCAQMD prepared a Draft Mitigated Negative Declaration (MND) and distributed a Notice of Intent to adopt the Draft MND (CEQA Guidelines §15072) to responsible public agencies and interested parties for review and comment. The Draft MND was distributed for a 30-day public review and comment period beginning on October 16, 2014, and ending on November 14, 2014. No comment letters were received from the public relative to the Draft MND. After the close of the public comment period, a Final MND was prepared for certification by the SCAQMD's decisionmaking body.

There are potentially significant adverse impacts to air quality, and greenhouse gases, and hazards and hazardous materials with construction of the proposed project. All significant adverse impacts, however, can be mitigated to less than significant levels.

Pursuant to CEQA Guidelines §15075(b) the Notice of Determination prepared for a MND project that has identified potentially significant effects that would be mitigated to a point where no significant effects would occur must include a statement indicating whether mitigation measures were made a condition of the approval of the project. Further, when changes or alterations have been required or incorporated into a project that mitigate or avoid the significant effects, the public agency is required to adopt a Mitigation Monitoring and Reporting Plan (CEQA Guidelines § 15097) for the changes made, in order to ensure compliance during project implementation.

The following sections of this document describe the proposed project and identify the significant adverse impacts that can be mitigated to below a significant level. Since all significant adverse effects can be mitigated to less than significant levels as identified in the Final MND and the Mitigation Monitoring and Reporting Plan, a Statement of Findings and a Statement of Overriding Considerations are not required for this project.

SUMMARY OF THE PROPOSED PROJECT

Exide is proposing to reduce toxic air emissions of arsenic, benzene and 1,3 butadiene by installing new equipment and modifying existing equipment, as summarized in Table 1-1.

Table 1-1 Summary of Proposed Project

Equipment Installation
<ul style="list-style-type: none"> • A new venturi and tray type wet scrubber (C203 and C202) would be installed to serve the main air pollution control system (APCS) for the blast furnace. The existing tray type (Neptune) scrubber (C43 and C42) will continue to service the reverberatory furnace. The existing Neptune scrubber stack and support structure would be replaced with a new stack and structure which would also service the new scrubber.
<ul style="list-style-type: none"> • Repurposed Baghouse No. 2 (Device C41) will be connected at the outlet of the new RTO (Device C205) and new pre-filtering baghouse to control the blast furnace charge hoods and thimble enclosure emissions. The repurposed baghouse will then be vented to the new scrubber to reduce the emissions of arsenic and SOx.
<ul style="list-style-type: none"> • Another new RTO (Device C199) would be installed on the outlet of the reverberatory furnace feed dryer APCS to reduce the emissions of toxic organic gases.
<ul style="list-style-type: none"> • Secondary high efficiency particulate air (HEPA) filtration would be installed downstream of the MAC baghouses to reduce particulate emissions containing lead, arsenic and other toxic metals.
<ul style="list-style-type: none"> • Installation of a radar-based charge level sensor within the blast furnace and temperature sensor at the top of the blast furnace to measure the feed burden within the furnace.
Equipment Modification
<ul style="list-style-type: none"> • The blast furnace thimble ventilation hoods (previously connected to the hard lead ventilation system) are being re-routed to the main APCS serving the blast furnace, which includes the new RTO (Device C205) and new scrubber (C203 and C202). The existing baghouse blower (250 brake horsepower (bhp)) would be replaced with a larger blower (450 bhp). A re-purposed baghouse, previously attached to the reverberatory furnace APCS, and now serving the blast furnace APCS, will also receive a new 450 bhp blower.
<ul style="list-style-type: none"> • The enclosure around the blast furnace charge area will be enhanced with additional ventilation air flow to serve as a secondary hood to capture any gases that could potentially escape the charge isolation door by the hoods at the top of the enclosure.
<ul style="list-style-type: none"> • The ventilation hood connected to the hard lead ventilation system serving the slag tap of the blast furnace would be enlarged and redirected to the new blast furnace baghouse that would be routed to the new scrubber.
<ul style="list-style-type: none"> • The existing ram feeding mechanisms on the reverberatory furnace would be replaced with screw feeders to reduce the potential for arsenic and organic-bearing process gases to be drawn into the soft lead ventilation system pickup hood or discharged into the smelting building atmosphere.

- The ventilation ducting serving two refining kettles would be removed from the hard lead ventilation system and redirected to the new blast furnace baghouse that would be routed to the new scrubber (C203 and C202).

In addition, because the proposed Revised Final RRP requires the new RTO, the Construction and Activity Mitigation Plan was also revised in August 2014 to include construction mitigation regarding the installation of the new RTO on the blast furnace charge hood. The applications of the measures are expected to ensure that concentrations remain within permissible levels by imposing the described requirements on the maintenance activity and the abatement of work activities, if concentrations exceed permissible levels. Mitigation measures have been added to explicitly require that the new RTO comply with the Plan. Those modified portions of the August 2014 Construction and Activity Mitigation Plan have been incorporated in the Final MND as mitigation measures MMAQ-01 and MMHAZ-01.

SIGNIFICANT ADVERSE IMPACTS WHICH CAN BE REDUCED BELOW A SIGNIFICANT LEVEL

The Final MND identified two potentially significant adverse impacts that can be reduced to a level of insignificance: 1) potentially significant cumulative adverse air quality impacts from construction activity of the new RTO on the blast furnace charge hood; and 2) potentially significant adverse impacts to hazards and hazardous materials associated with excavation and disposal of potential contaminated soil.

Air Quality and Greenhouse Gas Emissions

Due to compliance issues and as a result of an action brought by the SCAQMD in front of the SCAQMD Hearing Board, Exide prepared a Construction and Activity Mitigation Plan, dated July 2014. A July 2014 Construction and Activity Mitigation Plan was incorporated into an Order for Abatement (Case No. 3151-32) which was issued and made enforceable by the SCAQMD Hearing Board on July 10, 2014, pursuant to Health and Safety Code section 42451(b). The plan details how Exide will control and monitor fugitive metal TAC dust during construction and other plant activities. However, the August 2014 revision of the Final Risk Reduction Plan has not yet been incorporated into the Construction Activity Mitigation Plan and approved by the SCAQMD Hearing Board for inclusion into the Order for Abatement. Since the July 2014 Construction Activity Plan does not include the RTO on the blast furnace charge hood, the construction and installation requirements for this RTO are included in the Final MND as mitigation measures to ensure enforceability (the July 2014 Construction Activity Mitigation Plan is enforceable through the Hearing Board). Hence, mitigation measures, MMAQ-01 and MMAQ-02, have been crafted to reflect the August 2014 Construction Activity Mitigation Plan requirements for the blast furnace charge hood's new RTO construction.

MMAQ-01 – Prior to removal of the existing floor and underlying soil to allow installation of the foundations for the new Blast Furnace RTO and cartridge filter baghouse, Exide shall:

- A. Conduct activities within a building under negative pressure.

- B. Thoroughly clean the existing floor using HEPA vacuums followed by washing with potable water.
- C. Require the construction contractor to cut the concrete using wet methods to minimize generation of dust. The concrete being removed must be kept damp to minimize the generation of dust during the concrete demolition and removal activities.
- D. Apply a fine water mist directly on the demolition hammer point during the demolition activities and excavation activities.
- E. Capture and properly treat all water used for washing the floor and for other uses to prevent a secondary means of fugitive emissions into the air.

MMAQ-02 – Prior to the installation of the Blast Furnace RTO and cartridge filter baghouse, Exide shall:

- A. Conduct activities within a building under negative pressure.
- B. Wash all removed materials with potable water prior to placement into a container for proper offsite disposal or recycling.
- C. Place the scrap into a rolloff container that is staged inside of the total enclosure building.
- D. Cover the roll off container when not in use.
- E. Wash the exterior of the container with potable water and tarp the container prior to removal to outside of any enclosure buildings.

With the mitigation measures MMAQ-01 and MMAQ-02, construction TAC emissions are expected to be less than significant. All construction related activities to the new RTO would have the same construction controls as expected for the new RTO on the outlet of the rotary dryer, which was included in the July 2014 Construction Activity Mitigation Plan included Order for Abatement (Case No. 3151-32) and is expected to ensure that concentrations remain within permissible levels by imposing the described requirements on the maintenance activity and the abatement of work activities, if concentrations exceed permissible levels.

Hazards and Hazardous Materials

Based on DTSC's Corrective Action Consent Order and the DTSC Memo, the following mitigation measure has been created to ensure the reduction of potential hazardous materials impacts from any contaminated soil that may be encountered during excavation activities related to laying the foundations for control equipment, to a level below significance.

MMHAZ-01 – During the excavation phase of the proposed project, Exide shall:

- A. Notify DTSC at least 72 hours prior to each excavation.
- B. Identify, sample, characterize, handle, segregate, store, and dispose of excavated soils pursuant to local, state, and federal regulations and per the DTSC approved RFI Workplan (Section 9.0) and DTSC Consent Order.
- C. Remove at least five feet of soil under each slab foundation per DTSC's Memorandum on the Review of the Closure and Post Closure Care Cost Estimate

for Permit Renewal and Bankruptcy Court Claim as required by 22 CCR 66264.112(b)(4).

- D. Collect samples with the backhoe bucket after the bucket has scraped a clean surface on the area to be sampled. Excavation sidewall samples should be collected every 40 linear feet at an approximate 2.5 ft mid-point of the 5 foot excavation depth. With regard to the number of excavation bottom samples, the following DTSC guidance based on square footage should be used:

< 500 ft² – 2 samples
500 < 1,000 ft² - 3 samples
1,000 < 1,500 ft² - 4 samples
1,500 < 2,500 ft² - 5 samples
2,500 < 4,000 ft² - 6 samples
4,000 < 6,000 ft² - 7 samples
6,000 < 8,500 ft² - 8 samples
8,500 < 10,890 ft² - 9 samples

- E. Soil sample jars should be labeled properly and placed in zip-closure plastic bags in a chilled ice chest for transport to the analytical laboratory under chain-of-custody procedures pursuant to Section 9.0 of the DTSC approved RFI Workplan.
- F. Backfill per DTSC's "Information Advisory - Clean Import Fill Material" guidance, and cap the excavation areas immediately following sampling and prior to receipt of laboratory data.
- G. Dispose all excavated soil and demolished concrete foundation at a landfill licensed to handle the waste based on the results of sample characterization.

Since mitigation measure MMHAZ-01 is expected to fully remove any contaminated soils that may be found by excavating down to five feet in the disturbed area pursuant to DTSC's Memo, the proposed project is expected to be less than significant to the public and environment for hazards and hazardous material.

The August 2014 revision of the Construction Activity Mitigation Plan has not yet been approved by the SCAQMD Hearing Board for inclusion into the Order for Abatement (Case No. 3151-32). SCAQMD staff has determined that the same conditions related to soil, handling, and storage procedures from demolition for the new RTO on the reverberatory furnace feed stack should be incorporated into the Final MND to ensure enforceability. Hence, mitigation measure MMHAZ-02 has been crafted to reflect the August 2014 Construction Activity Mitigation Plan requirements for the blast furnace charge hood's new RTO soil, concrete handling, and storage procedures.

MMHAZ-02- Prior to the installation of the Blast Furnace RTO and cartridge filter baghouse, Exide shall:

- A. Transfer excavated concrete and soil into a rolloff container that is staged inside of the total enclosure building, for proper off-site disposal or recycling.

With mitigation measures MMHAZ-01 and MMHAZ-02, adverse hazards and hazardous material impacts, related to excavating the concrete and soil for the blast furnace charge hood new RTO, are expected to be less than significant because mitigation measure MMHAZ-02 uses the same construction emissions control (from the July 2014 Construction Activity Mitigation Plan) of the reverberatory furnace RTO.

SIGNIFICANT ADVERSE IMPACTS WHICH CANNOT BE REDUCED BELOW A SIGNIFICANT LEVEL

There are no potentially significant adverse environmental impacts that cannot be reduced to a level of insignificance for the proposed project.

MITIGATION MONITORING AND REPORTING PLAN

When a public agency adopts a mitigated negative declaration in conjunction with approving a project, the lead agency shall adopt a program for monitoring or reporting on the measures it has imposed to mitigate or avoid significant adverse environmental effects. PRC §21081.6 states in part:

When making the findings required by subdivision (a) of Section 21081 or when adopting a negative declaration pursuant to paragraph (2) of subdivision (c) of Section 21080, the public agency shall adopt a reporting or monitoring program for the changes to the project that it has adopted or made a condition of approval in order to mitigate or avoid significant effects on the environment. The reporting or monitoring program shall be designed to ensure compliance during project implementation. For those changes which have been required or incorporated into the project at the request of an agency having jurisdiction by law over natural resources affected by this project, that agency shall, if so requested by the lead or responsible agency, prepare and submit a proposed reporting or monitoring program.

Pursuant to the requirement of PRC §21081.6, the SCAQMD must establish a plan to monitor project compliance with those mitigation measures adopted as conditions of approval for BP's Compliance and Safety Project. The following subsections identify the specific mitigation measures identified in the MND and the public agency responsible for monitoring implementation of each mitigation measure.

AIR QUALITY AND GREENHOUSE GASES

Mitigation Measures MMAQ-01 and MMAQ-02 are required to minimize the potential short-term significant adverse air quality impacts during project construction.

IMPACT SUMMARY: Construction and installation activities for the new RTO on the blast furnace charge hood may have significant unmitigated cumulative air quality impacts. Since the July 2014 Construction Activity Plan does not include the RTO on the blast furnace charge hood, the construction and installation requirements for this RTO are included in the Final MND as mitigation measures to ensure enforceability (the July 2014 Construction Activity Mitigation Plan is enforceable through the Hearing Board).

Hence, mitigation measures, MMAQ-01 and MMAQ-02, have been crafted to reflect the August 2014 Construction Activity Mitigation Plan requirements for the blast furnace charge hood's new RTO construction.

Each element of the Mitigation Measures MMAQ-01 and MMAQ-02 are listed in Table 1, along with its Monitoring Action, Responsible Party, Enforcement Agency, and Monitoring Agency.

HAZARDS AND HAZARDOUS MATERIALS

Mitigation Measures MMHAZ-01 and MMHAZ-02 are required to minimize the potential significant adverse hazards and hazardous materials impacts during project construction.

IMPACT SUMMARY: There is a potential of hazardous materials impacts that may be encountered by ground disturbance associated with construction of the proposed project. Any such impact could be considered significant. The mitigation measures listed in Table 1 would reduce impacts to hazards and hazardous materials to less-than-significant in the event that unexpected hazardous materials were encountered.

Each element of the Mitigation Measures MMHAZ-01 and MMHAZ-02 are listed in Table 1, along with its Monitoring Action, Responsible Party, Enforcement Agency, and Monitoring Agency.

CONCLUSION

In accordance with the monitoring action items outlined in Table 1 and a sample reporting form provided in Table 2 of this Mitigation Monitoring and Reporting Plan, Exide will be required to document compliance with the mitigation measures prior to the start of construction and during the construction phase of the proposed project. The SCAQMD and Exide will evaluate the effectiveness of this Mitigation Monitoring and Reporting Plan during the construction period.

Table 1 - Mitigation Monitoring and Reporting Plan for Exide Toxic Air Contaminants Reduction Project

Mitigation Measure	Implementation Requirement	Party Responsible for Implementing Mitigation	Monitoring Action	1. Enforcement Agency 2. Monitoring Agency 3. Monitoring Phase
MMAQ-01 A.	Conduct activities within a building under negative pressure.	Exide	Maintain records to ensure the building maintains negative pressure (see sample form in Table 2).	1. SCAQMD 2. SCAQMD 3. Prior to the removal of the existing floor, underlying soil, and installation of the foundations for the new Blast Furnace RTO and cartridge filter baghouse
MMAQ-01 B.	Thoroughly clean the existing floor using HEPA vacuums followed by washing with potable water.	Exide	Maintain records to ensure the thorough cleaning (see sample form in Table 2).	1. SCAQMD 2. SCAQMD 3. Prior to the removal of the existing floor, underlying soil, and installation of the foundations for the new Blast Furnace RTO and cartridge filter baghouse
MMAQ-01 C.	Require the construction contractor to cut the concrete using wet methods to minimize generation of dust. The concrete being removed must be kept damp to minimize the generation of dust during the concrete demolition and removal activities.	Exide	Maintain records to ensure minimization of dust (see sample form in Table 2).	1. SCAQMD 2. SCAQMD 3. Prior to the removal of the existing floor, underlying soil, and installation of the foundations for the new Blast Furnace RTO and cartridge filter baghouse

Mitigation Measure	Implementation Requirement	Party Responsible for Implementing Mitigation	Monitoring Action	1. Enforcement Agency 2. Monitoring Agency 3. Monitoring Phase
MMAQ-01 D.	Apply a fine water mist directly on the demolition hammer point during the demolition activities and excavation activities.	Exide	Maintain records to ensure a fine water mist is applied directly on the demolition hammer (see sample form in Table 2).	1. SCAQMD 2. SCAQMD 3. Prior to the removal of the existing floor, underlying soil, and installation of the foundations for the new Blast Furnace RTO and cartridge filter baghouse
MMAQ-01 E.	Capture and properly treat all water used for washing the floor and for other uses to prevent a secondary means of fugitive emissions into the air.	Exide	Maintain records to ensure proper treatment of used water (see sample form in Table 2).	1. SCAQMD 2. SCAQMD 3. Prior to the removal of the existing floor, underlying soil, and installation of the foundations for the new Blast Furnace RTO and cartridge filter baghouse
MMAQ-02 A.	Conduct activities within a building under negative pressure.	Exide	Maintain records to ensure the building maintains negative pressure (see sample form in Table 2).	1. SCAQMD 2. SCAQMD 3. Prior to the installation of the Blast Furnace RTO and cartridge filter Baghouse
MMAQ-02 B.	Wash all removed materials with potable water prior to placement into a container for proper offsite disposal or recycling.	Exide	Maintain records to ensure the materials are contaminant free (see sample form in Table 2).	1. SCAQMD 2. SCAQMD 3. Prior to the installation of the Blast Furnace RTO and cartridge filter Baghouse

Mitigation Measure	Implementation Requirement	Party Responsible for Implementing Mitigation	Monitoring Action	1. Enforcement Agency 2. Monitoring Agency 3. Monitoring Phase
MMAQ-02 C.	Place the scrap into a rolloff container that is staged inside of the total enclosure building.	Exide	Maintain records to ensure scrap materials do not release fugitive contaminant emissions (see sample form in Table 2).	1. SCAQMD 2. SCAQMD 3. Prior to the installation of the Blast Furnace RTO and cartridge filter Baghouse
MMAQ-02 D.	Cover the roll off container when not in use.	Exide	Maintain records to ensure the container does not release fugitive dust emissions (see sample form in Table 2).	1. SCAQMD 2. SCAQMD 3. Prior to the installation of the Blast Furnace RTO and cartridge filter Baghouse
MMAQ-02 E.	Wash the exterior of the container with potable water and tarp the container prior to removal to outside of any enclosure buildings.	Exide	Maintain records to ensure the container does not release fugitive contaminant emissions (see sample form in Table 2).	1. SCAQMD 2. SCAQMD 3. Prior to the installation of the Blast Furnace RTO and cartridge filter Baghouse
MMHAZ-01 A.	Notify DTSC at least 72 hours prior to each excavation.	Exide	Provide written notification to DTSC	1. SCAQMD/DTSC 2. SCAQMD/DTSC 3. During the excavation phase of the proposed project

Mitigation Measure	Implementation Requirement	Party Responsible for Implementing Mitigation	Monitoring Action	1. Enforcement Agency 2. Monitoring Agency 3. Monitoring Phase
MMHAZ-01 B.	Identify, sample, characterize, handle, segregate, store, and dispose of excavated soils pursuant to local, state, and federal regulations and per the DTSC approved RFI Workplan (Section 9.0) and DTSC Consent Order.	Exide	Maintain records to ensure the proper handling of the excavated soils (see sample form in Table 2).	1. SCAQMD/DTSC 2. SCAQMD/DTSC 3. During the excavation phase of the proposed project
MMHAZ-01 C.	Remove at least five feet of soil under each slab foundation per DTSC's Memorandum on the Review of the Closure and Post Closure Care Cost Estimate for Permit Renewal and Bankruptcy Court Claim as required by 22 CCR 66264.112(b)(4).	Exide	Maintain records to ensure a sufficient depth was reached (see sample form in Table 2).	1. SCAQMD/DTSC 2. SCAQMD/DTSC 3. During the excavation phase of the proposed project

Mitigation Measure	Implementation Requirement	Party Responsible for Implementing Mitigation	Monitoring Action	1. Enforcement Agency 2. Monitoring Agency 3. Monitoring Phase
MMHAZ-01 D.	Collect samples with the backhoe bucket after the bucket has scraped a clean surface on the area to be sampled. Excavation sidewall samples should be collected every 40 linear feet at an approximate 2.5 ft mid-point of the 5 foot excavation depth. With regard to the number of excavation bottom samples, the following DTSC guidance based on square footage should be used: < 500 ft ² – 2 samples 500 < 1,000 ft ² - 3 samples 1,000 < 1,500 ft ² - 4 samples 1,500 < 2,500 ft ² - 5 samples 2,500 < 4,000 ft ² - 6 samples 4,000 < 6,000 ft ² - 7 samples 6,000 < 8,500 ft ² - 8 samples 8,500 < 10,890 ft ² - 9 samples	Exide	Maintain records to ensure the proper samples were collected (see sample form in Table 2).	1. SCAQMD/DTSC 2. SCAQMD/DTSC 3. During the excavation phase of the proposed project
MMHAZ-01 E.	Soil sample jars should be labeled properly and placed in zip-closure plastic bags in a chilled ice chest for transport to the analytical laboratory under chain-of-custody procedures pursuant to Section 9.0 of the DTSC approved RFI Workplan.	Exide	Maintain records to ensure proper soil protocols and chain of custody (see sample form in Table 2).	1. SCAQMD/DTSC 2. SCAQMD/DTSC 3. During the excavation phase of the proposed project

Mitigation Measure	Implementation Requirement	Party Responsible for Implementing Mitigation	Monitoring Action	1. Enforcement Agency 2. Monitoring Agency 3. Monitoring Phase
MMHAZ-01 F.	Backfill per DTSC’s “Information Advisory - Clean Import Fill Material” guidance, and cap the excavation areas immediately following sampling and prior to receipt of laboratory data.	Exide	Maintain records to ensure the proper backfill and cap (see sample form in Table 2).	1. SCAQMD/DTSC 2. SCAQMD/DTSC 3. During the excavation phase of the proposed project
MMHAZ-01 G.	Dispose all excavated soil and demolished concrete foundation at a landfill licensed to handle the waste based on the results of sample characterization.	Exide	Maintain records to ensure proper disposal of the soil and concrete (see sample form in Table 2).	1. SCAQMD/DTSC 2. SCAQMD/DTSC 3. During the excavation phase of the proposed project
MMHAZ-02 A.	Transfer excavated concrete and soil into a rolloff container that is staged inside of the total enclosure building, for proper off-site disposal or recycling.	Exide	Maintain records to ensure the container does not release fugitive dust emissions (see sample form in Table 2).	1. SCAQMD 2. SCAQMD 3. Prior to the installation of the Blast Furnace RTO and cartridge filter baghouse

ATTACHMENT 2

SOUTH COAST AIR QUALITY MANAGEMENT DISTRICT

Adoption of a Mitigated Negative Declaration

Title: Toxic Air Contaminant Reduction for Compliance with SCAQMD Rules 1420.1 and 1402 at the Exide Technologies Facility Project ("Exide")

Location: Exide Technologies, 2700 South Indiana Street, Vernon, CA 90058

WHEREAS, Exide has applied to the SOUTH COAST AIR QUALITY MANAGEMENT DISTRICT (SCAQMD) for the issuance of permits to construct various air pollution control equipment including two thermal oxidizers, two scrubbers and dust collectors; and

WHEREAS, the authority to approve permits and certify any associated California Environmental Quality Act (CEQA) document is granted to the Executive Officer by Health & Safety Code § 42300(a), but if delegation were required, has been expressly and implicitly delegated to the Executive Officer and his staff by the SCAQMD Governing Board pursuant to Health & Safety Code §§ 40480, 40482, and SCAQMD Regulation II and recognized under CEQA Guidelines § 15074; and

WHEREAS, as lead agency for the project under CEQA, the SCAQMD has prepared a Mitigated Negative Declaration (MND) which evaluated the potential significant adverse environmental effects of the proposed project, and by this reference, is incorporated as if fully set forth herein; and

WHEREAS, the MND concluded that implementation of the Project could result in potential significant effects on air quality (construction) and hazards, and identified mitigation measures that would reduce the significant effects to a less-than-significant level; and

WHEREAS, in connection with the approval of a project involving the preparation of an MND that identifies one or more significant environmental effects, CEQA requires the lead agency to incorporate feasible mitigation measures that would reduce those significant environment effects to a less-than-significant level; and

WHEREAS, whenever a lead agency approves a project requiring the implementation of measures to mitigate or avoid significant effects on the environment, CEQA also requires a lead agency to adopt a Mitigation Monitoring and Reporting Plan to ensure compliance with the mitigation measures during project implementation; and

WHEREAS, a Mitigation Monitoring and Reporting Plan has been prepared pursuant to Public Resources Code § 21081.6 or CEQA Guidelines § 15097 for the proposed project; and

WHEREAS, no comment letters were received on the Draft MND; and

WHEREAS, the Project will not individually or cumulatively have an adverse effect on wildlife resources, as defined in Section 711.2 of the California Department of Fish and Game Code.

NOW, THEREFORE, BE IT RESOLVED, that Exide agrees that

1. Exide (and its successor[s]) acknowledges that the SCAQMD has the authority to impose mitigation measures described in the Mitigation Monitoring and Reporting Plan, and to make them conditions of project approval.
2. Exide (and its successor[s]) acknowledges that the SCAQMD has the authority to enforce the mitigation measures contained in the Mitigation Monitoring and Reporting Plan through SCAQMD Rule 221, and to enforce conditions which require compliance with the Mitigation Monitoring and Reporting Plan or specific mitigation measures contained therein. Exide also acknowledges that the SCAQMD has the authority to enforce this Agreement by bringing an action in the appropriate court of the State of California.
3. Exide (and its successor[s]) shall comply with all mitigation measures contained in the Mitigation Monitoring and Reporting Plan adopted by the Executive Officer as a condition of approval of the Exide project.

BE IT FURTHER RESOLVED, that the Executive Officer does hereby make the following findings: (1) he has independently reviewed and analyzed the Final MND and other information in the record and has considered the information contained therein, prior to acting upon or approving the Project, (2) the Final MND prepared for the Project has been completed in compliance with CEQA and consistent with state and local guidelines implementing CEQA, and (3) the Final MND represents the independent judgment and analysis of the SCAQMD as lead agency for the Project. The Executive Officer for the SCAQMD designates the SCAQMD CEQA Supervisor at 21865 Copley Drive, Diamond Bar, California 91765, as the custodian of documents and records of proceedings on which this decision is based.

BE IT FURTHER RESOLVED, the Executive Officer does hereby approve issuance of permits for the Exide Technologies Facility Project to install new air pollution control equipment; adopt a Final MND prepared for the project; and approve the Mitigation Monitoring and Reporting Plan.

Dated: 12/4/14.

Signed: _____

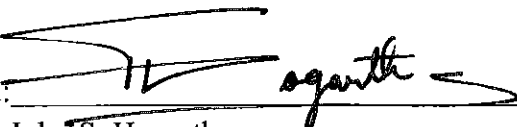
John S. Hogarth
Plant Manager
Exide Technologies

Dated: 12/5/2014

Signed: _____

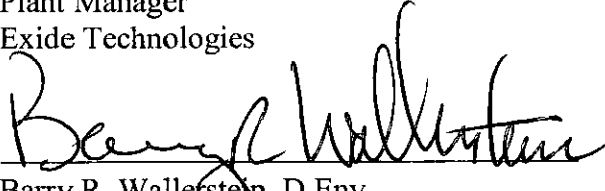
Barry R. Wallerstein, D.Env.
Executive Officer
South Coast Air Quality Management District

SOUTH COAST AIR QUALITY MANAGEMENT DISTRICT

Final Mitigated Negative Declaration for:

Toxic Air Contaminant Reduction for Compliance with SCAQMD Rules 1420.1 and 1402 at the Exide Technologies Facility in Vernon, CA

December 2014

State Clearinghouse: 2014101040
SCAQMD No. 140903JK

Executive Officer

Barry R. Wallerstein, D. Env.

Deputy Executive Officer

Planning, Rule Development and Area Sources

Elaine Chang, DrPH

Assistant Deputy Executive Officer

Planning, Rule Development and Area Sources

Philip Fine, Ph.D.

Director of Strategic Initiatives

Planning, Rule Development and Area Sources

Susan Nakamura

Author:	James Koizumi	Air Quality Engineer II
Technical Assistance:	Marco Polo Thomas Liebel Charles Tupac	Air Quality Engineer II Senior Air Quality Engineer AQ Analysis & Compliance Supervisor
Reviewed By:	Michael Krause Cynthia Carter Barbara Baird Megan Lorenz Veera Tyagi	CEQA Program Supervisor Air Quality Specialist Chief Deputy Counsel Senior Deputy District Counsel Senior Deputy District Counsel

**SOUTH COAST AIR QUALITY MANAGEMENT DISTRICT
GOVERNING BOARD**

CHAIRMAN: DR. WILLIAM A. BURKE
Speaker of the Assembly Appointee

VICE CHAIR: DENNIS R. YATES
Mayor, City of Chino
Cities Representative, San Bernardino County

MEMBERS:

MICHAEL D. ANTONOVICH
Supervisor, Fifth District
Los Angeles County Representative

BEN BENOIT
Mayor Pro Tem, Wildomar
Cities of Riverside County

JOHN J. BENOIT
Supervisor, Fourth District
Riverside County Representative

JOE BUSCAINO
Councilman, Fifteenth District
City of Los Angeles Representative

MICHAEL A. CACCIOTTI
Mayor, City of South Pasadena
Cities of Los Angeles County, Eastern Region

JOSIE GONZALES
Supervisor, Fifth District
San Bernardino County Representative

JOSEPH K. LYOU, PH.D.
Governor's Appointee

JUDITH MITCHELL
Mayor, Rolling Hills Estates
Cities of Los Angeles County, Western Region

SHAWN NELSON
Supervisor, Fourth District
Orange County Representative

DR. CLARK E. PARKER, SR.
Senate Rules Committee Appointee

MIGUEL A. PULIDO
Mayor, City of Santa Ana
Cities Representative, Orange County

EXECUTIVE OFFICER:
BARRY R. WALLERSTEIN, D.Env.

PREFACE

This document constitutes the Final Mitigated Negative Declaration (MND) for the Toxic Air Contaminant Reduction for Compliance with SCAQMD Rules 1420.1 and 1402 at the Exide Technologies Facility Project. The Draft MND was released for a 30-day public review and comment period from October 16, 2014 to November 14, 2014. No comment letters were received from the public relative to the environmental analysis in the Draft MND. The environmental analysis in the Draft MND concluded that the proposed project would not generate adverse significant air quality impacts after feasible mitigation measures are implemented.

No modifications were made to the proposed project subsequent to release of the Draft MND for public review. As a result, conclusions reached in the Draft MND do not change and thus, does not require recirculation of the document pursuant to CEQA Guidelines §15088.5. Therefore, this document now constitutes the Final MND for the Toxic Air Contaminant Reduction for Compliance with SCAQMD Rules 1420.1 and 1402 at the Exide Technologies Facility Project.

TABLE OF CONTENTS

CHAPTER 1

1.0	Introduction.....	1-2
1.1	Key Components of the Proposed Project	1-3
	1.1.1 Rule 1402 Risk Reduction Plan.....	1-3
	1.1.2 Permit Applications	1-3
1.2	California Environmental Quality Act.....	1-3
	1.2.1 Previous Rule 1420.1 CEQA Documentation	1-5
1.3	Project Location	1-5
1.4	Project Background.....	1-7
	1.4.1 Overview of Current Operations	1-7
	1.4.2 Air Toxic Regulations	1-9
	1.4.3 Other Compliance Requirements	1-11
	1.4.3.1 Mitigation Plan for Construction of Risk Reduction Measures	1-11
	1.4.3.1 Resource Conservation and Recovery Act (RCRA)	1-12
1.5	Project Description.....	1-14
	1.5.1 Rotary Dryer Air Pollution Control System Modification.....	1-16
	1.5.2 Air Pollution Control System No. 1 Modifications.....	1-16
	1.5.3 Air Pollution Control System No. 2 Modifications.....	1-16
	1.5.4 Pot Furnaces Emissions Control Modifications	1-17
1.6	Required Permits and Approvals	1-18

CHAPTER 2

2.0	Introduction.....	2-1
2.1	General Information.....	2-1
2.2	Environmental Factors Potentially Affected.....	2-3
2.3	Determination	2-4
2.4	Discussion and Evaluation of Environmental Impacts	2-5
	I Aesthetics	2-11
	II Agricultural and Forest Resources.....	2-14
	III Air Quality and Greenhouse Gas Emissions.....	2-15
	IV Biological Resources	2-47
	V Cultural Resources	2-49
	VI Energy.....	2-51
	VII Geology and Soils	2-57
	VIII Hazards and Hazardous Materials	2-60
	IX Hydrology and Water Quality.....	2-69
	X Land Use and Planning	2-78
	XI Mineral Resources	2-79
	XII Noise	2-80
	XIII Population and Housing.....	2-84
	XIV Public Services.....	2-85
	XV Recreation	2-86
	XVI Solid and Hazardous Waste	2-87
	XVII Transportation and Traffic	2-92
	XVIII Mandatory Findings of Significance.....	2-94

TABLE OF CONTENTS (CONTINUED)

LIST OF FIGURES

Figure 1-1	Exide Technologies Vernon Facility	1-6
Figure 1-2	Risk Management Plan Diagram.....	1-19
Figure 1-3	Flow Chart 1 of the Changes to the Exide Facility	1-20
Figure 1-4	Flow Chart 2 of the Changes to the Exide Facility	1-21
Figure 2-1	View of the Existing Exide Facility	2-13
Figure 2-2	Areas Where Existing Foundations and Soil Would Be Excavated.....	2-65

LIST OF TABLES

Table 1-1	Summary of Proposed Project.....	1-15
Table 2-1	Elements Analyzed in the 2014 Final EA for Rule 1420.1 and Proposed Project Elements Evaluated in This ND.....	2-7
Table 2-2	SCAQMD Air Quality Significance Thresholds.....	2-17
Table 2-3	2014 Final EA for Rule 1420.1 Peak Daily Construction Emissions	2-18
Table 2-4	Longest Distances Traveled by Hazardous Waste Haul Truck Used to Estimate Peak Emissions in Each Jurisdiction	2-22
Table 2-5	Proposed Project Peak Daily Construction Emissions in SCAQMD.....	2-23
Table 2-6	Proposed Project Construction Criteria Pollutant Emissions in the MDAQMD Jurisdiction	2-24
Table 2-7	Proposed Project Construction Criteria Pollutant Emissions in the GBUAPCD Jurisdiction	2-25
Table 2-8	Proposed Project Construction Criteria Pollutant Emissions in Arizona.....	2-26
Table 2-9	Proposed Project Construction Criteria Pollutant Emissions in Nevada.....	2-26
Table 2-10	Proposed Project Peak Daily On-site Construction Emissions	2-27
Table 2-11	2014 Final EA for Rule 1420.1 Operational Criteria Pollutant Emissions	2-28
Table 2-12	2014 Final EA for Rule 1420.1 Operational Criteria Pollutant Emissions Emissions in the MDAQMD Jurisdiction	2-29
Table 2-13	Proposed Project Peak Daily Operational Criteria Pollutant Emissions	2-30
Table 2-14	Proposed Operational Criteria Pollutant Emissions in the MDAQMD Jurisdiction	2-31
Table 2-15	Proposed Operational Criteria Pollutant Emissions in the GBUAPCD Jurisdiction	2-32
Table 2-16	Proposed Operational Criteria Pollutant Emissions in Arizona.....	2-33
Table 2-17	Proposed Operational Criteria Pollutant Emissions in Nevada.....	2-33
Table 2-18	Proposed Project On-site Peak Daily On-site Operational Criteria Pollutant Emissions.....	2-34
Table 2-19	2014 Final EA for Rule 1420.1 Health Risk from Natural Gas Combustion.....	2-40
Table 2-20	Proposed Project Health Risk from Natural Gas Combustion	2-41
Table 2-21	Power Ratings of New and Replaced Equipment	2-53
Table 2-22	Total Projected Natural Gas Demand from 2014 Final EA for Rule 1420.1	2-54
Table 2-23	Wastewater Discharge.....	2-77
Table 2-24	City of Vernon Noise Requirements	2-81
Table 2-25	Construction Noise Sources	2-82
Table 2-26	Construction Vibration Sources	2-83
Table 2-27	Metal Emissions for Reporting Years 2010 to 2012	2-90

TABLE OF CONTENTS (CONCLUDED)

APPENDIX A – Assumptions and Calculations

APPENDIX B – Proposed Revised Final Risk Reduction Plan Rule 1402

APPENDIX C – Approved Mitigation Plan for Construction of Risk Reduction Measures,
RCRA RFI Sampling and Other Plant Activities, July 2014

APPENDIX D – Proposed Revised Mitigation Plan for Construction of Risk Reduction
Measures, RCRA RFI Sampling and Other Plant Activities, August 2014

CHAPTER 1

PROJECT DESCRIPTION

Introduction

California Environmental Quality Act

Project Location

Project Background

Project Description

Required Permits and Approvals

1.0 INTRODUCTION

The proposed project is intended to reduce toxic emissions of arsenic, benzene and 1,3-butadiene to comply with the recent amendments made to SCAQMD Rule 1420.1 - Emission Standards for Lead and Other Toxic Air Contaminants from Large Lead-Acid Battery Recycling Facilities, as well as to assure compliance with requirements in SCAQMD Rule 1402 - Control of Toxic Air Contaminants from Existing Sources including the proposed Final Revised Risk Reduction Plan. This will be accomplished by ensuring exhaust gas streams containing high levels of arsenic emissions are vented to appropriate air pollution control systems capable of controlling arsenic emissions which exist in gaseous or unfilterable form. The proposed project will also control gas streams containing gaseous organic air contaminants, carbon monoxide, and oxides of sulfur which previously escaped control because they were vented only to dry filter media or were emitted into the building enclosure due to a lack of sufficient negative pressure in the reverberatory and blast furnaces.

Rule 1420.1 – Emission Standards for Lead from Lead-Acid Battery Recycling Facilities was adopted on November 5, 2010 and applies to large lead-acid battery recycling facilities that process more than 50,000 tons of lead a year. The purpose of Rule 1420.1 is to protect public health by reducing exposure to emissions of lead from these facilities and to help to ensure attainment of the National Ambient Air Quality Standard for lead. Rule 1420.1 was amended on January 10, 2014 to reduce arsenic, benzene, and 1,3-butadiene emissions from affected facilities. It was amended again on March 7, 2014 to include a multi-metals demonstration program to continuously monitor lead, arsenic, and other metals and clarify language that requires affected facilities to reimburse SCAQMD for funds spent to deploy independent third-party contractors who conduct investigations of unplanned shutdowns according to Rule 1420.1. The amendment renamed the rule as Rule 1420.1 - Emission Standards for Lead and Other Toxic Air Contaminants from Large Lead-Acid Battery Recycling Facilities, to reflect these changes.

The Exide Technologies (Exide) facility at 2700 South Indiana Street in Vernon, California 90058 is one of two facilities that currently fall within the ambit of Rule 1420.1. In March 2013, the SCAQMD staff approved a Health Risk Assessment pursuant to Rule 1402 for Exide Technologies that showed a maximum individual cancer risk of 156 in one million, a chronic hazard index of 63, and a cancer burden of 10. All of these health risk values exceed the cancer and non-cancer health risk thresholds established under the South Coast Air Quality Management District (SCAQMD) Rule 1402, which regulates toxic emissions from existing facilities. Rule 1402 requires a facility to reduce its maximum health risk to 25 in a million or less with an approved health risk reduction plan, which details a development and implementation schedule. The January 2014 amendments to Rule 1420.1 require large lead-acid battery recycling facilities to meet emission limits for arsenic, benzene, and 1,3-butadiene which are the primary contributors to the elevated health risks at large lead-acid battery recycling facilities. The January 2014 amendments to Rule 1420.1 also contain additional administrative, monitoring and source testing requirements for stack emissions.

In accordance with the California Environmental Quality Act (CEQA), the SCAQMD adopted the Final Environmental Assessment (EA) for Proposed Amended Rule 1420.1 - Emission Standards for Lead and Other Toxic Air Contaminants from Large Lead-Acid Battery Recycling Facilities (January 2014, SCAQMD No. 131010JK, State Clearinghouse No. 2013101035, <http://www.aqmd.gov/docs/default-source/ceqa/documents/aqmd->

projects/2014/par_1420_fea.pdf) on January 10, 2014. The 2014 Final EA for Rule 1420.1 evaluated the amendments and no significant environmental impacts were identified.

1.1 KEY COMPONENTS OF THE PROPOSED PROJECT

1.1.1 RULE 1402 RISK REDUCTION PLAN

Based on previous health risk assessments and source tests, Exide was required to submit a risk reduction plan pursuant to Rule 1402, with actions that assist in meeting Rule 1420.1 requirements. A detailed history of the health risk assessments, source tests and risk reduction plans are presented in the Project Background of this Chapter of the Draft MND (see below). The latest version of this plan is the August 2014 Proposed Revised Final Risk Reduction Plan, which includes a new scrubber on the blast furnace air pollution control system, a repurposed baghouse and a new RTO on the blast furnace charging enclosure; a new RTO to be placed on the reverberatory furnace feed dryer stack; replacement of the reverberatory feed mechanism; enclosure of the blast furnace charge area; installation of charge level and temperature sensors in the blast furnace; changes to hoods and ducting; and installation of a secondary HEPA filtration system downstream of the hard lead ventilation system baghouse and MAC feed room baghouse.

1.1.2 PERMIT APPLICATIONS

Exide submitted permit applications to modify equipment according to the proposed August 2014 Revised Final Risk Reduction Plan, which is designed to comply with Rules 1420.1 and 1402.

This CEQA analysis evaluates potential environmental impacts from the issuance of permit applications for the equipment associated with the August 2014 Revised Final Risk Reduction Plan and all other activity required by the plan.

1.2 CALIFORNIA ENVIRONMENTAL QUALITY ACT

CEQA (Public Resources Code §21000 et seq., and Title 14 California Code of Regulations §15000 et seq. (CEQA Guidelines)), requires that the environmental impacts of proposed projects be evaluated and that feasible methods to reduce, avoid or eliminate significant adverse impacts of these projects be identified and implemented, if feasible. The lead agency is the public agency that has the principal responsibility for carrying out or approving a project that may have a significant effect upon the environment (Public Resources Code §21067). The proposed project requires discretionary approval from the SCAQMD for air quality permits for modifications to existing stationary source equipment and installation of new stationary source equipment and, therefore, it is subject to the requirements of CEQA. Because the SCAQMD has the primary responsibility for supervising or approving the entire project as a whole it is the most appropriate public agency to act as lead agency (CEQA Guidelines §15051(b)).

CEQA Guidelines Section 15002(a) - General Concepts identifies the basic purposes of CEQA: to inform public agency decision-makers and the public generally of the significant environmental effects of a project, identify possible ways to minimize the significant effects through the use of mitigation measures or alternatives to the project, and disclose to the public the reasons why a government agency approved the project if significant environmental effects are involved.

CEQA Guidelines § 15189 applies to projects that consist solely of compliance with a performance standard or treatment requirement which was the subject of an environmental analysis as described in CEQA Guidelines § 15187. The Final EA for Proposed Amended Rule 1420.1 - Emission Standards for Lead and Other Toxic Air Contaminants from Large Lead-Acid Battery Recycling Facilities (2014 Final EA for Rule 1420.1, January 2014, SCAQMD No. 131010JK, State Clearinghouse No. 2013101035, http://www.aqmd.gov/docs/default-source/ceqa/documents/aqmd-projects/2014/par_1420_fea.pdf) was prepared as required by CEQA Guidelines § 15187, which states that an environmental analysis of the reasonable foreseeable methods by which compliance with the rule or regulation will be achieved must be performed at the time of adoption. The 2014 Final EA for Rule 1420.1 included an analysis of reasonably foreseeable environmental impacts from the various methods of compliance. No mitigation measures or alternatives were evaluated because no significant adverse impacts were identified. The environmental analysis took into account a reasonable range of environmental, economic, and technical factors, population and geographic areas, and specific sites.

CEQA Guidelines § 15189 (a) states that if preparing a MND on the compliance project the lead agency for the compliance project shall, to the greatest extent feasible, use the environmental analysis prepared pursuant to CEQA Guidelines § 15187. It also states that the lead agency has an obligation to identify and evaluate the environmental effects of the project. Therefore, in accordance with CEQA, SCAQMD is the Lead Agency and has prepared this Draft MND for the proposed project, which to the greatest extent feasible, uses the environmental analysis prepared pursuant to CEQA Guidelines § 15187 in the 2014 Final EA for Rule 1420.1. The 2014 Final EA for Rule 1420.1 evaluated amendments to Rule 1420.1 to reduce arsenic, benzene, and 1,3-butadiene emissions. No significant impacts were identified to any environmental topic in the 2014 Final EA for Rule 1420.1. This Draft MND has been prepared to analyze environmental effects of the proposed Revised Final Risk Reduction Plan, including the installation and modification of air pollution control equipment, which is identified in associated air quality permit applications from Exide. SCAQMD's review of the proposed project, which incorporates by reference the environmental analysis in the 2014 Final EA for Rule 1420.1, shows that the project would not have a potentially significant adverse effect on the environment, except in the areas of Air Quality and Greenhouse Gas Emissions; and Hazardous and Hazardous Materials, which would be mitigated to less than significant by mitigation measures MMAQ-01, MMAQ-02, MMHAZ-01 and MMHAZ-02.

Therefore, pursuant to CEQA Guidelines §15071 (e), Air Quality and Greenhouse Gas Emissions; and Hazardous and Hazardous Materials mitigation measures for this Draft MND are intended to reduce impacts to less than significant and an Environmental Impact Report (EIR) is not required. Since an EIR is not required, no alternatives need to be evaluated pursuant to CEQA Guidelines §15126.6. A mitigation monitoring plan will be developed pursuant to CEQA Guidelines §15074 (d). This determination is supported by the evidence and analysis contained in the 2014 Final EA for Rule 1420.1 and the environmental checklist contained in this Draft MND. Although not required, comment letters received for this Draft MND during the 30-day public review period and the responses to those comments will be included in an appendix of the Final MND.

1.2.1 PREVIOUS RULE 1420.1 CEQA DOCUMENTATION

Final Environmental Assessment for October 2010 Rule 1420.1, SCAQMD No. 100331JK, SCH No. 2010041086

A Final EA was prepared for Rule 1420.1 – Emission Standards for Lead from Lead-Acid Battery Recycling Facilities, which was adopted on November 5, 2010. The EA evaluated Rule 1420.1 which was developed to protect public health by reducing exposure to emissions of lead from large lead-acid battery recycling facilities that process more than 50,000 tons of lead a year and to help to ensure attainment of the National Ambient Air Quality Standard (NAAQS) for lead. No significant adverse effects were identified to any environmental topic. The Draft EA was released for a 30-day public review and comment period from April 27, 2010 to May 26, 2010. No comment letters were received on the Draft EA during the comment period. Two comment letters were received after the public comment period and are included with response to comments in Appendix C of the Final EA.

Final Environmental Assessment for January 2014 Amended Rule 1420.1, SCAQMD No. 131010JK, SCH No. 2013101035)

A Final EA was prepared for amendments to Rule 1420.1 - Emission Standards for Lead and Other Toxic Air Contaminants from Large Lead-Acid Battery Recycling Facilities, which was adopted on January 10, 2014. The EA evaluated amendments to reduce arsenic, benzene, and 1,3-butadiene emissions. The amendments included requirements for ambient air concentration limits for arsenic, as well as hourly emission limits of arsenic, benzene, and 1, 3-butadiene. The amendments also contained additional administrative, monitoring and source testing requirements for stack emissions. The Draft EA was released for a 30-day public review and comment period from October 10, 2013 to November 8, 2013. One comment letter was received on the Draft EA. No significant adverse effects were identified to any environmental topic. Two letters on the proposed amendments to Rule 1420.1 were received that included comments on the Draft EA. All three comment letters and responses to the comments on the Draft EA are included in Appendix C of the Final EA.

Notice of Exemption for Proposed Amended Rule 1420.1, March 7, 2014

A Notice of Exemption (NOE) was prepared for the amendments to Rule 1420.1 adopted on March 8, 2014. The amendments included a multi-metals demonstration program to continuously monitor lead, arsenic, and other metals and clarifying language that requires affected facilities to reimburse SCAQMD for funds spent to deploy independent third-party contractors who conduct investigations of unplanned shutdowns according to Rule 1420.1.

1.3 PROJECT LOCATION

The Exide Technologies facility (2700 South Indiana Street, Vernon, CA 90058) is located in the city of Vernon (see Figure 1-1), on approximately 24 acres of land. The parcel is zoned for heavy Industrial (Zone M-2) and other parcels in the vicinity are zoned either Manufacturing or Commercial¹. The closest sensitive receptor is a residential receptor 1,400 meters to the north of the facility. The closest worker receptor is 100 meters to the northeast of the facility.

¹ Department of Toxic Substance Control (DTSC), Fact Sheet for the Draft Permit and Draft Environmental Impact Report for Exide Technologies, 2006.



Source: Google Map Maker

Figure 1-1
Exide Technologies Vernon Facility

1.4 PROJECT BACKGROUND

1.4.1 OVERVIEW OF CURRENT OPERATIONS

Lead-acid battery recycling facilities are secondary lead smelting operations where spent lead-acid batteries, mostly automotive, and other lead-bearing materials are received from various sources and processed to recover lead, plastics, and acids. The process mainly involves the sorting, melting, and refining of lead-acid batteries, which ultimately produces lead ingots that are then made into new batteries or sold to other entities. Below is a general description of the process including potential lead, arsenic, benzene, and 1,3-butadiene emission points:

Phase I – Raw Materials Processing: Lead-bearing materials recovered from lead-acid batteries are prepared and processed prior to being charged (loaded) to a smelting furnace. The feedstock for lead-acid battery recycling facilities can fluctuate. The majority of the feedstock is plastic-cased car batteries.

Receiving and Storage: Spent lead-acid batteries are usually received on pallets and the batteries are either stored or sent directly to conveyors for immediate crushing.

Battery Breaking/Crushing: The spent lead-acid batteries are unloaded from conveyors and loaded into a hammer mill system where they are crushed whole. Exide's battery breaking areas are located in a total enclosure that is vented to an emission collection system pursuant to Rule 1420.1. The crushed material is then placed into a series of tanks filled with water in order to filter out any plastic and rubber components of the battery casing and to clean materials of the acids. Through buoyancy effects, the crushed metal material sinks to the bottom of the tanks and goes through a series of screens to further isolate lead-bearing materials. Arsenic and other metals can be found in the lead-bearing materials due to battery parts such as the posts and grids containing alloys of arsenic and lead. The materials are then typically stored in open or partially covered piles if not required for immediate charge preparation (see below).

Charge Preparation/Rotary Drying: Recovered lead-bearing materials are prepared by blending them with stored lead scrap and reagents prior to being charged to a furnace. The metallic scrap materials are placed in dryers to remove moisture prior to charging to a furnace in order to reduce furnace upsets. Some unfiltered plastic and rubber components of the battery casing may be inadvertently introduced into the dryer during this process. The process of pyrolyzing plastic and rubber parts and the partial combustion of carbon coke (mainly in the dryers) generates toxic organic emissions such as benzene and 1,3-butadiene.

Phase II – Smelting: Smelting is the production of crude lead by melting and separating the lead from metallic and non-metallic contaminants and by reducing lead compounds to elemental lead. Smelting is carried out in the blast and reverberatory furnaces.

Cupola (Blast) furnaces: Typically, "hard" lead, or antimonial lead is produced in blast furnaces. Scrap metal, re-run slag, scrap iron, coke, recycled dross, flue dust (which contains lead and arsenic), and limestone are used as charge materials to the furnace. Process heat is produced by the reaction of the charged coke with blast air that is blown into the furnace.

Reverberatory furnaces: Semi-soft lead (containing less than approximately three to four percent antimony) is produced in reverberatory furnaces, which generate lead and arsenic emissions. Lead scrap, metallic battery parts, oxides, dross, and other residues are used as charge materials to the furnace. The charge materials are heated directly using natural gas, and generate benzene and 1,3-butadiene emissions.

Phase III – Refining and Casting: Refining and casting the crude lead from the smelting process can consist of softening, alloying, and oxidation, depending on the degree of purity or alloy type desired. Crude lead produced during smelting operations is remelted and refined by the addition of reagents, such as sulfur and caustic soda. The purified lead is then cast into molds or ingots. Refining furnaces and kettles are indirectly gas-fired and maintained at operating temperatures between 600 to 1,300 degrees Fahrenheit. Arsenic fumes may be emitted when molten lead is alloyed with metallic arsenic in the refining kettles and lead particulates may become airborne off refining kettle contents due to disturbance of solid lead oxides which form on the surface of hot, molten lead (i.e., physical removal of dross and chemical residues from the pot furnaces during normal operation).

Alloying furnaces: Alloying furnaces are kettle furnaces used to mix molten lead with alloy materials, such as antimony, tin, arsenic, copper, and nickel. Other reagents used include sodium hydroxide, sodium nitrate, carbon coke, and calcium metal.

Refining furnaces: Refining furnaces are used to either remove copper and antimony for soft lead production, or to remove arsenic, copper, and nickel for hard lead production. Sulfur may be added to the molten lead to remove copper. The resultant copper sulfide is skimmed off as dross and may be processed in a blast furnace to recover residual lead.

1.4.2 AIR TOXIC REGULATIONS

In 1987, the California legislature adopted the Air Toxics “Hot Spots” Information and Assessment Act (AB 2588). The goals of the Act are to collect emissions data of toxic air contaminants, identify facilities having localized impacts, to determine health risks, and to notify affected individuals. Later amendments required preparation of a health risk reduction plan to bring health risks below SCAQMD Governing Board adopted levels. Exposure to toxic air contaminants may produce various adverse health impacts. Potential adverse health impacts include cancer and non-cancer health impacts, and the non-cancer health impacts can be characterized as chronic and acute risks.

Rule 1402 was adopted on April 8, 1994 and reduces the health risk associated with emissions of toxic air contaminants from existing sources by specifying limits for cancer and non-cancer risk thresholds applicable to total facility emissions. Under Rule 1402 the health risk thresholds are as follows:

- Maximum individual cancer risk of 25 in one million;
- Cancer burden of 0.5; and
- Non-cancer acute or chronic hazard indices of 3.0.

Facilities that exceed any threshold are required to submit and implement risk reduction plans to achieve specified risk limits as quickly as possible, but no later than three years from the initial risk reduction plan submittal date. Rule 1402 also specifies public notification and inventory requirements.

In April 1999, SCAQMD initially approved Exide’s AB 2588 Health Risk Assessment (HRA) with a cancer risk of 2.3 in a million, acute hazard index of 0.53, and a chronic hazard index of 0.04. The cancer risks were primarily due to arsenic and cadmium emissions and the non-cancer risks were primarily from lead emissions.

In December 2006, SCAQMD requested that Exide submit an updated AB 2588 HRA because Exide reported chlorinated dioxins and furans emissions were not considered in the previous AB 2588 HRA. Exide submitted the updated AB 2588 HRA in July 2007 and it estimated cancer risks to be 10.7 in a million (primarily from arsenic, lead, and polychlorinated dibenzofurans), non-cancer acute hazard index to be 0.1 (primarily from arsenic), and the non-cancer chronic hazard index to be 0.056 (primarily from cadmium, sulfuric acid, and hydrogen sulfide). In July 2010, SCAQMD determined that the source tests used to estimate toxic emissions from the facility and for the HRA were inadequate and required that a new series of source tests be conducted.

Exide conducted numerous source tests from September 2010 to October 2011 and a HRA was submitted pursuant to the AB 2588 program in February 2012. Due to SCAQMD comments and additional source tests, Exide prepared and submitted a Revised HRA in January 2013. SCAQMD staff reviewed, modified, and approved as modified the Revised HRA in March 2013. The approved Revised HRA reported a maximum individual cancer risk of 156 in one million, a non-cancer chronic hazard index of 63, a non-cancer acute hazard index of 3.8, and a cancer burden of 10; thus triggering risk reduction requirements under Rule 1402 because all health risk thresholds were exceeded. The maximum individual cancer risk was calculated at a worker receptor (who is closer to the emission source than a nearby resident). The Revised HRA

showed that the primary risk drivers were arsenic, and to a lesser extent benzene and 1,3-butadiene.

On August 28, 2013, Exide submitted a draft Risk Reduction Plan (RRP) to comply with SCAQMD Rule 1402. Rule 1402(g)(1) provides up to three months for the SCAQMD staff to review and approve (or reject) the draft RRP. On October 24, 2013, SCAQMD rejected Exide's submitted draft RRP as being inadequate to ensure the required health risk reductions.

During the time of RRP revisions, Exide had to comply with SCAQMD adopted November 5, 2010 Rule 1420.1 lead emissions standards. The purpose of Rule 1420.1 is to protect public health by reducing exposure to emissions of lead from these facilities and to help to ensure attainment of the National Ambient Air Quality Standard for lead. On January 10, 2014, SCAQMD amended Rule 1420.1 to include reductions of arsenic, benzene, and 1,3-butadiene emissions from the facility. It was amended again on March 7, 2014 to include a multi-metals demonstration program to continuously monitor lead, arsenic, and other metals and clarify language that requires affected facilities to reimburse SCAQMD for funds spent to deploy independent third-party contractors who conduct investigations of unplanned shutdowns according to Rule 1420.1.

Exide submitted a revised RRP on January 17, 2014 to include compliance with Rule 1420.1 requirements and the SCAQMD responded in a letter dated February 12, 2014 with further concerns. Exide submitted their Final RRP on March 4, 2014 to address SCAQMD staff comments. The Final RRP was reviewed and approved by SCAQMD staff on March 19, 2014. However, after consultation with SCAQMD staff in July 2014, Exide representatives proposed a revision to the design set forth in the approved March 2014 RRP. These changes were incorporated into the August 2014 proposed Revised Final RRP for Rule 1402 submitted by Exide to SCAQMD staff. The proposed Revised Final RRP addresses the concerns and comments that SCAQMD staff discussed with Exide relative to air pollution control system design for the blast furnace and its associated charging area ventilation system. This CEQA analysis includes the Revised Final RRP and the air quality permits for implementing the Revised Final RRP.

1.4.3 OTHER COMPLIANCE REQUIREMENTS

1.4.3.1 MITIGATION PLAN FOR CONSTRUCTION OF RISK REDUCTION MEASURES

Due to compliance issues and as a result of an action brought by the SCAQMD in front of the SCAQMD Hearing Board, Exide prepared a Mitigation Plan for Construction of Risk Reduction Measures, RCRA RFI Sampling, and Other Plant Activities (hereinafter referred to as Construction and Activity Mitigation Plan, see Appendix B) dated July 2014. The Construction and Activity Mitigation Plan was incorporated into an Order for Abatement (Case No. 3151-32) which was issued and made enforceable by the SCAQMD Hearing Board on July 10, 2014, pursuant to Health and Safety Code section 42451(b). The plan details how Exide will control fugitive metal TAC dust during construction and other plant activities. The goal of the Construction and Activity Mitigation Plan is to exceed SCAQMD regulatory requirements to prevent emissions of lead and other toxic metals during any construction and maintenance activity occurring onsite. The plan includes a requirement for continuous air monitoring during any construction or maintenance activity, with requirements to stop work if an adverse dust concentration is detected, and a requirement to continue work only if there is no increase in dust concentration from the activity through the implementation of measures described in the plan.

However, the July 2014 Construction and Activity Mitigation Plan did not account for the August 2014 proposed Revised Final RRP. The proposed Revised Final RRP is contingent on Exide's updated design to the pollution control equipment. To ensure that the August 2014 Revised Final RRP is required to comply with the Construction and Activity Mitigation Plan, a new August 2014 Construction and Activity Mitigation Plan was drafted to include construction mitigation for the Revised Final RRP's updated design, but has not yet been approved by the Hearing Board. To ensure that the August 2014 Construction and Activity Mitigation Plan's requirements for construction and maintenance activities are followed for the updated design and that this project's potential impacts are adequately mitigated, CEQA mitigation measures (MMAQ-01, MMAQ-02, MMHAZ-02) were added. For more details, see sections Air Quality and Greenhouse Gas Emissions; and Hazards and Hazardous Materials.

The Construction and Activity Mitigation Plan also includes the following mitigations for existing and on-going activities:

- Enclosing drilling and soil related to Resource Conservation and Recovery Act (RCRA) Facility Investigation (RFI) soil sampling;
- Enclosing construction areas with fire resistant poly sheeting and using a negative air unit during reverb furnace maintenance activities (brick replacement) and tank/sump repairs of Tank 12;
- Wipe cleaning during A-pipe welding;
- Tarping and using a negative air unit during fiberglass repair work needed on the internal lining of Tank 24;
- Enclosing and using a negative air unit during concrete repair of manholes as part of the storm water pipping project completion/restoration;
- Daily vacuuming work areas before and after work is done repairing the smelting building's production office;
- Restricting feed piles and loaders to feed rooms while installing sprinklers;
- Using HEPA vacuums during drilling for the installation of security surveillance cameras;

- Coordinating with SCAQMD inspectors and following general measures in Construction and Activity Mitigation Plan for additional similar plant maintenance activities.

Since the requirements are existing and include dust reduction measures in support of the requirements in Rule 1420.1, no additional analysis of the aforementioned items are required, thus, no additional evaluation was conducted.

1.4.3.2 Resource Conservation and Recovery Act (RCRA)

Congress enacted the Solid Waste Disposal Act of 1965 to address the growing quantity of solid waste generated in the United States and to ensure its proper management. The Resource Conservation and Recovery Act was passed by Congress in 1976, as an amendment to the Solid Waste Disposal Act of 1965, to ensure that solid wastes are managed in an environmentally sound manner.

In 1992, the California Department of Toxic Substances Control (DTSC) received authorization from the United States Environmental Protection Agency (U.S. EPA) to implement RCRA, Subtitle C requirements and the associated regulations. Receiving authorization from the U.S. EPA means that DTSC is the primary authority enforcing the RCRA hazardous waste requirements in California. RCRA Subtitle C establishes standards for the generation, transportation, treatment, storage, and disposal of hazardous waste in the United States.

Exide has applied for a permit to operate and has submitted a Part B Permit Application to DTSC (under California Code of Regulations Title 22, Section 66270, Article 2). The permit request is for the continuance of current operations that involve the treatment, storage and transfer of hazardous and non-hazardous waste related to the recycling of used automotive batteries and other lead-bearing material into reusable lead ingots and the recycling of polypropylene material. The permit is needed for the Exide Vernon facility to continue to operate under Health and Safety Code, Division 20, Chapter 6.5 and California Code of Regulations, Title 22, Division 4.5.

Hazardous waste facility permit applicants are required by federal and state regulations to perform a RCRA Facility Assessment (RFA). The RFA identifies activities or areas that have the potential to cause a release of hazardous substances into the air, soil or groundwater. GNB Technologies (now Exide) conducted a RFA at the Vernon facility in 1990 to determine if contamination resulted from existing or previous operations at the Vernon facility or operations adjacent to the site. Additional solid waste management units and areas of concern were identified in the DTSC's review of Exide's May 1997 RCRA Part B Application. Based on this information DTSC identified solid waste management units where releases of hazardous waste has potentially occurred (Unit 3: Battery Storage Area, Unit 6: Earthen Acid Dump Pit, Unit 9: Hard Rubber Chip Wastepile, Unit 10: Old Battery Separation Building, Unit 11: Old Mixed Metals Extrusion Building, Unit 12: Zinc Alloy Operations Area, Unit 14: Smelting Pots, Unit 15: Lead Oxide Building Warehouse, Unit 24: Rainwater Retention Pond, Unit 28: Polypropylene Loading Dock and Unit 29: Crushed Drum Storage Piles). A Corrective Action Consent Order (Docket No: P3-01/02-010) was signed between Exide and DTSC on February 25, 2002, that details steps required by DTSC to determine the extent of any impacts from the solid waste units identified at the Vernon facility and the steps necessary to determine the most viable corrective solutions. Exide is currently performing the RCRA Facility Investigation (RFI)

to provide information upon which clean up measures can be proposed and ultimately developed into a work plan.

DTSC has also recently mandated Interim Measures, including street and sidewalk cleaning, cleaning neighboring rooftops, and cleaning flood control channels and storm drains to mitigate impacts from the facility's operation.

1.5 PROJECT DESCRIPTION

SCAQMD source tests have shown that the type of arsenic emissions from the blast furnace have been determined to contain a significant fraction of arsenic compounds in the gaseous or unfilterable ultrafine particulate phase. The blast furnace hard lead baghouse captures the large particles of arsenic emissions, but the gas phase arsenic particles are too small to be filtered. The gaseous arsenic, expected to be mainly in the form of arsenic trioxide, based on chemistry, readily dissolves into the water. However, it has been determined that a significant amount of process gases were escaping capture by the Neptune scrubber system due to low flow rates, low pressure and leaks. The proposed new scrubber system is intended to adequately control arsenic emissions.

Benzene and 1,3- butadiene emissions also exist as dilute, gaseous air contaminants. The main air pollution control system was designed to control these emissions by sending them through the afterburner. However, benzene and 1,3- butadiene emissions have been measured leaving the hard lead baghouse. Baghouses do not control gases, only particulates. By better controlling the gas phase emissions (preventing them from going to the hard lead baghouse or the room air), there will be a net reduction in these air contaminants and in health risk.

Exide submitted air quality permit applications to modify equipment according to the August 2014 Revised Final Risk Reduction Plan, which is designed to comply with Rules 1420.1 and 1402. The proposed project evaluates the activities surrounding the installation and operation of equipment under the Revised Final RRP and associated air quality permit applications.

Originally, Exide planned on installing a new scrubber on the blast furnace air pollution control system, repurpose a baghouse and enhance an existing afterburner serving the blast furnace; a new RTO to be placed on the reverberatory furnace feed dryer stack; replace the reverberatory feed mechanism; enclose the blast furnace charge area; install charge level and temperature sensors in the blast furnace; change hoods and ducting; and install a secondary HEPA filtration system downstream of the hard lead ventilation system baghouse. The updated design required by the proposed Revised Final RRP includes an additional RTO, repurposed baghouse, and new scrubber controlling the blast furnace charge hood (i.e., charging enclosure) emissions instead of enhancing the afterburner.

The elements of the August 2014 proposed Revised Final Risk Reduction Plan include the following:

- Additional RTO and repurposed baghouse to be placed between the blast furnace charge hood and a new scrubber placed at the end;
- New RTO to be placed on the reverberatory furnace feed dryer stack;
- Replacement of the reverberatory feed mechanism;
- Enclosure of the blast furnace charge area;
- Installation of charge level and temperature sensors in the blast furnace; changes to hoods and ducting;
- Installation of a secondary HEPA filtration system downstream of the hard lead ventilation system baghouse and the MAC feed room baghouse.

Figure 1-2 presents the layout of the proposed changes at Exide. Figures 1-3 and 1-4 are process flow diagrams at the Exide facility, including the changes pursuant to the proposed project (changes are bolded in red).

Exide is proposing to reduce toxic air emissions of arsenic, benzene and 1,3 butadiene by installing new equipment and modifying existing equipment, as summarized in Table 1-1.

**Table 1-1
Summary of Proposed Project**

Equipment Installation
<ul style="list-style-type: none"> • A new venturi and tray type wet scrubber (C203 and C202) would be installed to serve the main air pollution control system (APCS) for the blast furnace. The existing tray type (Neptune) scrubber (C43 and C42) will continue to service the reverberatory furnace. The existing Neptune scrubber stack and support structure would be replaced with a new stack and structure which would also service the new scrubber.
<ul style="list-style-type: none"> • Repurposed Baghouse No. 2 (Device C41) will be connected at the outlet of the new RTO (Device C205) and new pre-filtering baghouse to control the blast furnace charge hoods and thimble enclosure emissions. The repurposed baghouse will then be vented to the new scrubber to reduce the emissions of arsenic and SO_x.
<ul style="list-style-type: none"> • Another new RTO (Device C199) would be installed on the outlet of the reverberatory furnace feed dryer APCS to reduce the emissions of toxic organic gases.
<ul style="list-style-type: none"> • Secondary high efficiency particulate air (HEPA) filtration would be installed downstream of the MAC baghouses to reduce particulate emissions containing lead, arsenic and other toxic metals.
<ul style="list-style-type: none"> • Installation of a radar-based charge level sensor within the blast furnace and temperature sensor at the top of the blast furnace to measure the feed burden within the furnace.
Equipment Modification
<ul style="list-style-type: none"> • The blast furnace thimble ventilation hoods (previously connected to the hard lead ventilation system) are being re-routed to the main APCS serving the blast furnace, which includes the new RTO (Device C205) and new scrubber (C203 and C202). The existing baghouse blower (250 brake horsepower (bhp)) would be replaced with a larger blower (450 bhp). A re-purposed baghouse, previously attached to the reverberatory furnace APCS, and now serving the blast furnace APCS, will also receive a new 450 bhp blower.
<ul style="list-style-type: none"> • The enclosure around the blast furnace charge area will be enhanced with additional ventilation air flow to serve as a secondary hood to capture any gases that could potentially escape the charge isolation door by the hoods at the top of the enclosure.
<ul style="list-style-type: none"> • The ventilation hood connected to the hard lead ventilation system serving the slag tap of the blast furnace would be enlarged and redirected to the new blast furnace baghouse that would be routed to the new scrubber.
<ul style="list-style-type: none"> • The existing ram feeding mechanisms on the reverberatory furnace would be replaced with screw feeders to reduce the potential for arsenic and organic-bearing process gases to be drawn into the soft lead ventilation system pickup hood or discharged into the smelting building atmosphere.
<ul style="list-style-type: none"> • The ventilation ducting serving two refining kettles would be removed from the hard lead ventilation system and redirected to the new blast furnace baghouse that would be routed to the new scrubber (C203 and C202).

In addition, because the proposed Revised Final RRP requires the new RTO, the Construction and Activity Mitigation Plan was also revised in August 2014 (see Appendix C) to include construction mitigation regarding the installation of the new RTO on the blast furnace charge

hood. The applications of the measures are expected to ensure that concentrations remain within permissible levels by imposing the described requirements on the maintenance activity and the abatement of work activities, if concentrations exceed permissible levels. Mitigation measures have been added to explicitly require that the new RTO comply with the Plan. Those modified portions of the August 2014 Construction and Activity Mitigation Plan have been incorporated in this Draft MND as mitigation measures MMAQ-01 and MMHAZ-01.

1.5.1 ROTARY DRYER AIR POLLUTION CONTROL SYSTEM MODIFICATION

A regenerative thermal oxidizer (RTO) would be installed on the outlet of the rotary dryer air pollution control system to reduce the emissions of toxic organic gases and carbon monoxide. This system currently contains a cyclone separator, baghouse and HEPA filter dust collector. The RTO will be installed on the outlet of the HEPA filter dust collector.

The rotary dryer removes moisture from the feed material which is charged to the reverberatory furnace, as referenced below.

1.5.2 AIR POLLUTION CONTROL SYSTEM NO. 1 (REVERBERATORY FURNACE AIR POLLUTION CONTROL SYSTEM) MODIFICATIONS

A new RTO (Device C199) would be installed on the outlet of the reverberatory furnace rotary dryer air pollution control system to reduce the emissions of toxic organic gases and carbon monoxide. This system currently contains a cyclone separator, baghouse and HEPA filter dust collector. The RTO will be installed on the outlet of the HEPA filter dust collector.

The main process gas air pollution control system serving the reverberatory furnace, known as Air Pollution Control System no. 1 (APCS No. 1) will also be modified. This system currently contains two baghouses connected in parallel which are designated to handle the process gases from the reverberatory furnace. One of these baghouses (device C41) would be disconnected from APCS No. 1 (this baghouse is currently not operationally required in APCS No. 1 and has not been used for a number of years) and connected to the Blast Furnace Air Pollution Control System (APCS No. 2). The repurposed baghouse would be used to vent additional equipment vented by proposed APCS No. 2 including two lead pot furnaces, an RTO exhaust outlet, an enhanced cupola thimble hood enclosure and an enhanced blast furnace slag tapping hood.

A new venturi scrubber and a new tray scrubber (C203 and C202) are proposed to increase the air flow rate primarily from the blast furnace and secondarily to provide additional ventilation to the reverberatory furnace. The existing tray type Neptune scrubber (C43 and C42) would continue to support the reverberatory furnace. The increased air flow rates are intended to ensure that negative pressure is maintained in both furnaces.

The existing ram feeding mechanisms on the reverberatory furnace would be replaced with screw feeders to reduce the potential for arsenic and organic-bearing process gases to be drawn into the soft lead ventilation system pickup hood or discharged into the smelting building atmosphere.

1.5.3 AIR POLLUTION CONTROL SYSTEM NO. 2 (CUPOLA AIR POLLUTION CONTROL SYSTEM) MODIFICATIONS

The process air flow rate in the cupola (blast) furnace would be increased from 10,000 actual cubic feet per minute to as much as 15,000 actual cubic feet per minute (as needed) by pulling more air from this furnace. The enclosure around the blast furnace charge area would be enhanced with additional ventilation air flow (25,000 ACFM) to serve as a secondary hood to capture gases escaping the charge isolation door and escaping the hoods located at the top of the isolation door. The 15,000 ACFM increased air flow rate would ensure that negative pressure is maintained in this furnace for compliance with Rule 1420.1. The 25,000 ACFM increased air flow rate will ensure that no fugitive emissions from the thimble charge area escape control by the main APCS. The baghouse (Device C41) would be used to control additional equipment vented by proposed APCS 2 including two lead pot furnaces, an RTO exhaust outlet, an enhanced cupola thimble hood enclosure and an enhanced blast furnace slag tapping hood. The pot furnaces were previously vented to the hard lead baghouse (Device C46). The slag tapping hood would be enlarged to better capture gases which are released during slag tapping operations. In addition, the thimble hood vents, previously connected to the hard lead baghouse (Device C46) would now be rerouted to another RTO (Device C205). The applicant is also proposing to enhance the integrity of the blast furnace thimble cover enclosure to ensure that fugitive emissions are not released from the top of the blast furnace. Air from the thimble enclosure and hoods (25,000 actual cubic feet per minute) would be vented to the RTO. Installation of a radar-based charge level sensor within the blast furnace and temperature sensor at the top of the blast furnace to measure the feed burden within the furnace would be installed in order to enhance feed level control in the blast furnace for the purpose of better controlling the negative pressure inside of this furnace.

The afterburner firing rate was originally designed to handle 10,000 actual cubic feet per minute of air. It would now be able to handle a maximum of 15,000 actual cubic feet per minute of air under the current proposal. The existing burners would be used. The start-up procedure would require a graduated increase in air flow rate until the blast furnace is fired on a sufficient amount of carbon coke to maintain minimum required temperature in the afterburner. Any emissions escaping the thimble charge area during startup will be captured by the 25,000 ACFM enhanced thimble enclosure and routed to the new RTO and the main APCS.

1.5.4 POT FURNACES EMISSIONS CONTROL MODIFICATIONS

The pot furnaces (Devices D7 and D9) would be rerouted from the hard lead baghouse ventilation system to blast furnace Baghouse No. 2 (Device C41). Permit conditions would be modified to prevent the charging of arsenic metal to all pot furnaces except for Devices D7 and D9. The purpose of these modifications is to ensure that any major arsenic emissions would be controlled by the wet scrubber system in APCS No. 2.

Secondary high efficiency particulate air (HEPA) filtration would be installed downstream of the MAC baghouses which vent the building enclosure and the pot furnaces' burner exhaust manifold to reduce particulate emissions containing lead, arsenic and other toxic metals. The burner exhaust manifold (Device B206) is, physically, a confined space (room) located under the pot furnaces into which the natural gas combustion exhaust from the pot burners is emitted. This room has an exhaust blower which vents it to the MAC baghouses.

1.6 REQUIRED PERMITS AND APPROVALS

New and modified air pollution control systems, supporting equipment, and modifications to the reverberatory furnace feeding system would require air quality permits from the SCAQMD. Building (structural) and foundation permits would be required by the City of Vernon Building Department. Plumbing permits would be required by the City of Vernon Mechanical Department. Electrical and fire permits may also be required from the City of Vernon. The Draft MND analyzes the potential impacts of the project and these permits or discretionary actions required to implement it.

Exide would have to demonstrate to the City of Vernon that their Business Plan was updated to reflect the new and modified equipment. Labeling and tracking of hazardous waste would need to be described in the Business Plan.

Since wastewater discharge from the new scrubber is expected to be within the discharge rates allowed by the Industrial Wastewater Discharge Permit, no modification of wastewater discharge permits are expected to be needed from the Los Angeles Sanitation District and Regional Water Quality Control Board.

Although not anticipated, any changes to update the hazardous waste permit would need approval of the California Department of Toxic Substance Control (DTSC).

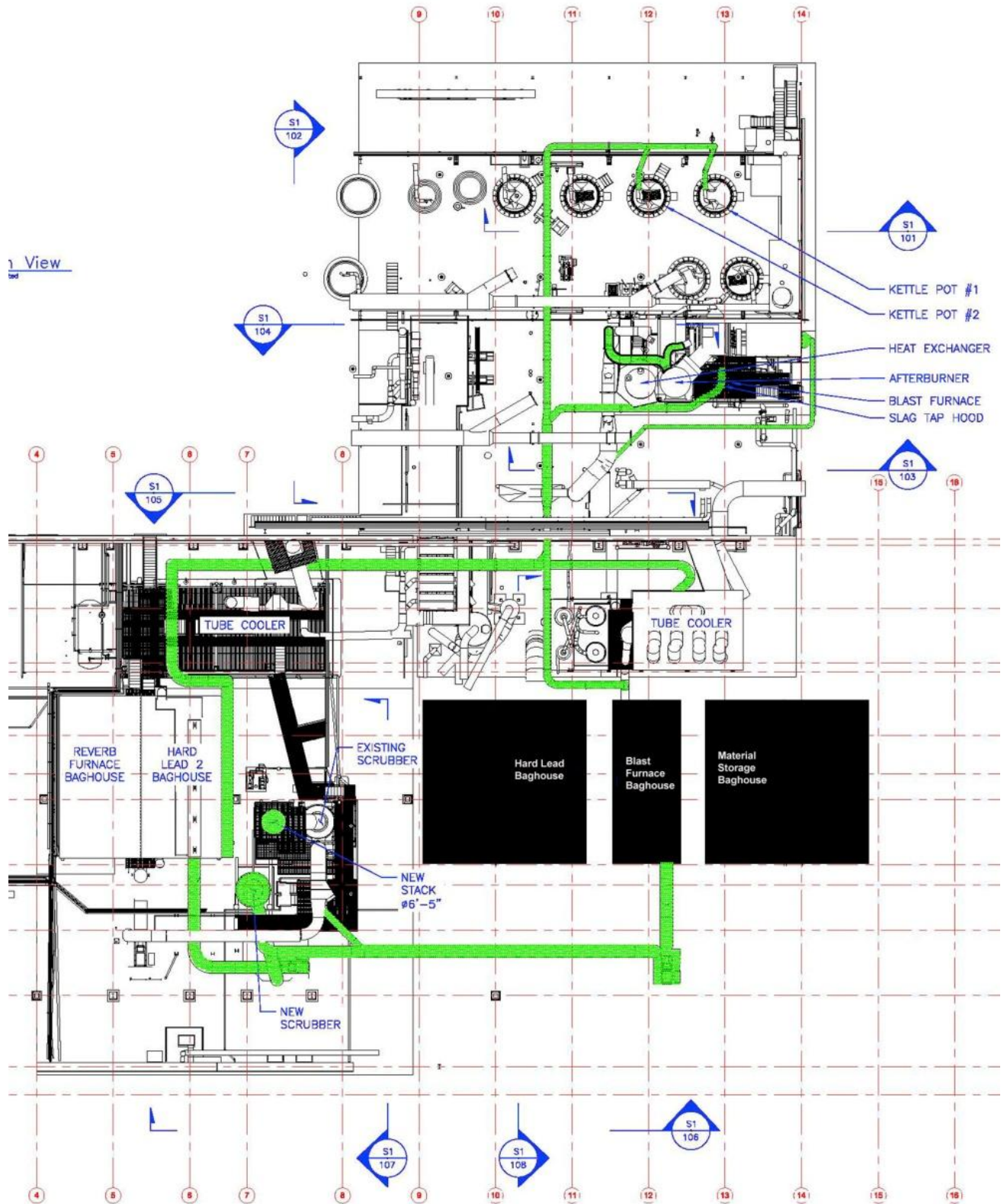

Figure 1-2
Risk Management Plan Diagram

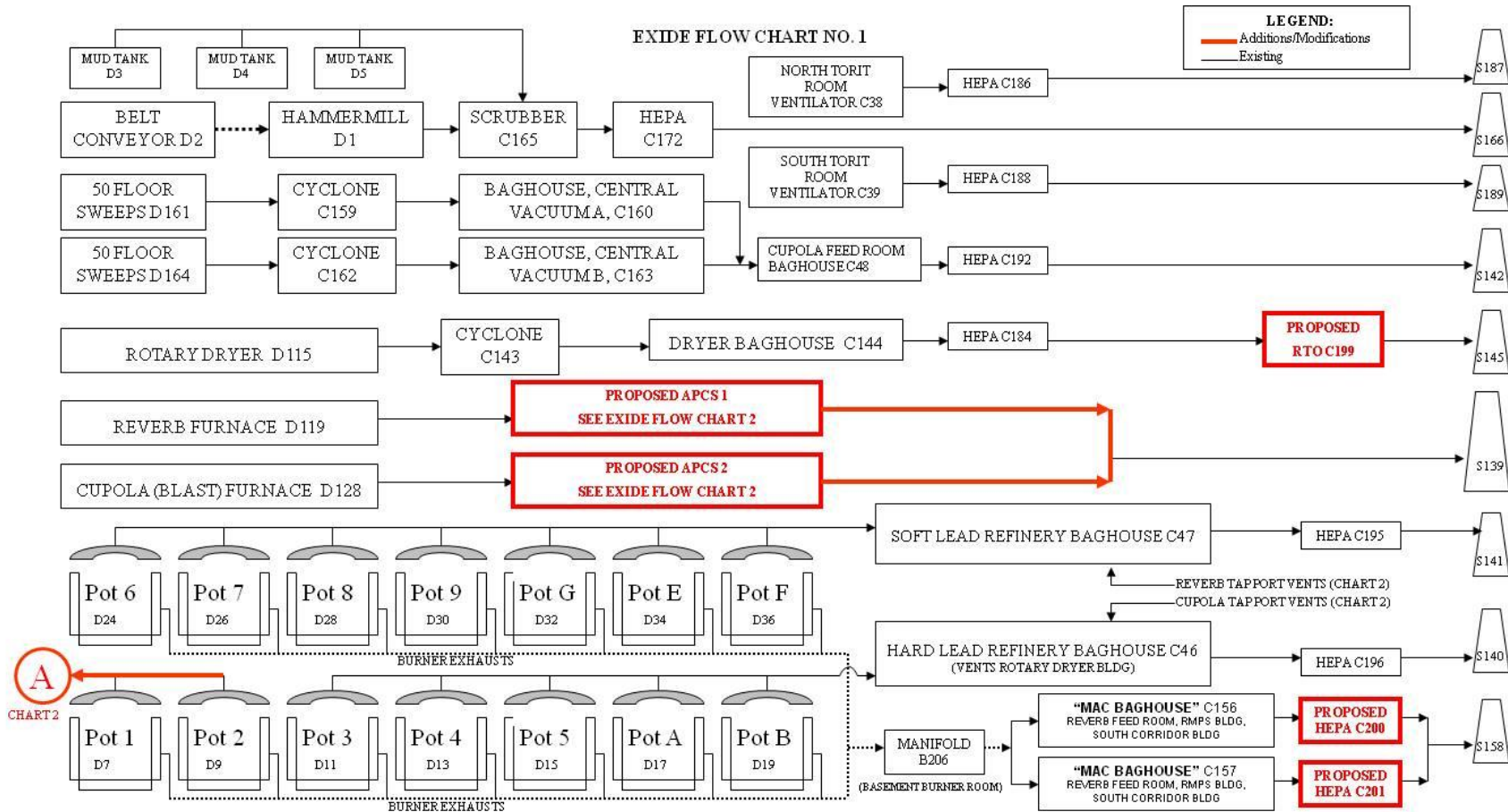

Figure 1-3
Flow Chart 1 of the Changes to the Exide Facility

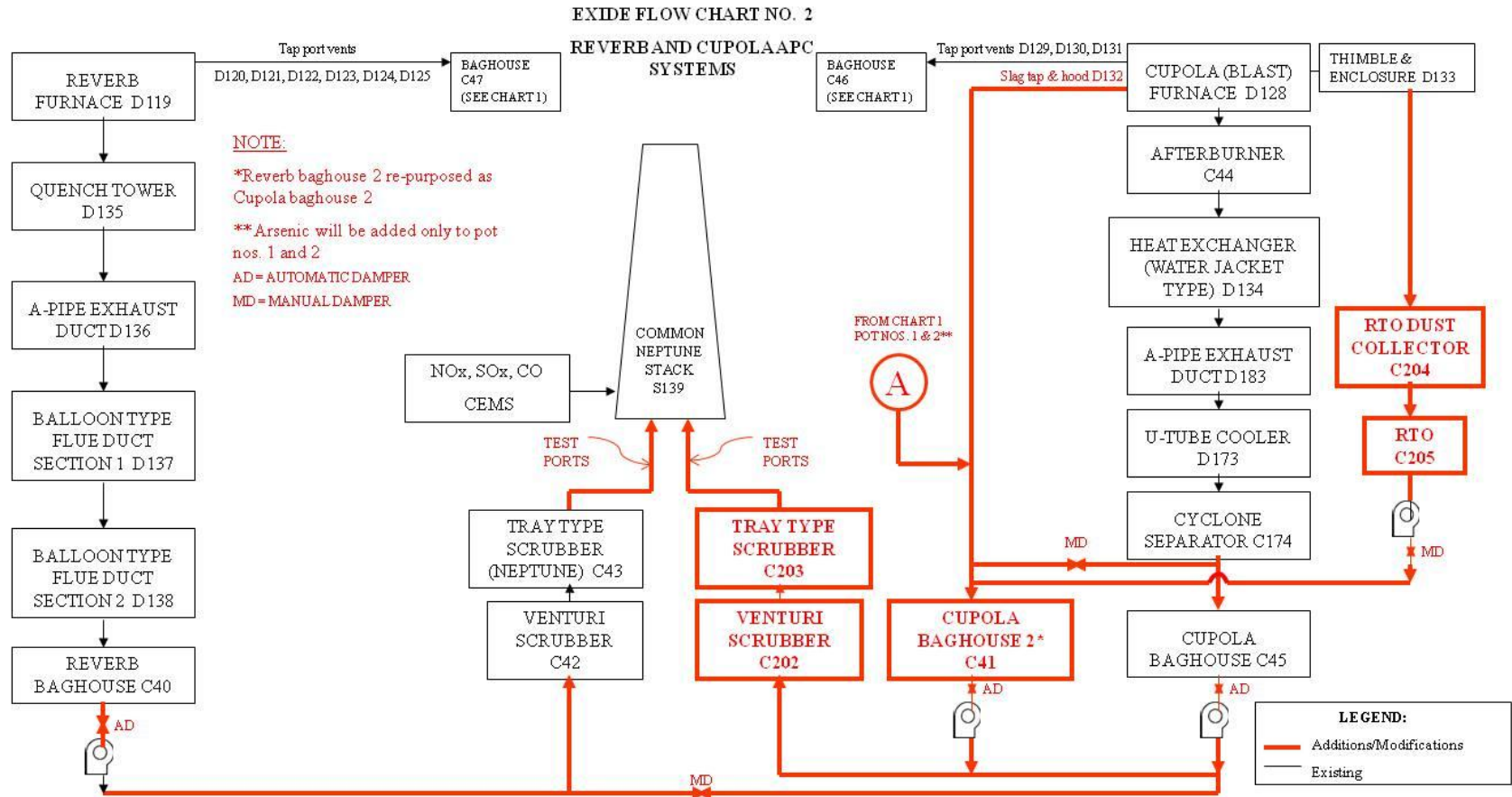

Figure 1-4
Flow Chart 2 of the Changes to the Exide Facility

CHAPTER 2

Introduction

General Information

Environmental Factors Potentially Affected

Determination

Environmental Checklist and Discussion

2.0 INTRODUCTION

The environmental checklist provides a standard evaluation tool to identify a project's adverse environmental impacts. This checklist identifies and evaluates potential adverse environmental impacts that may be created by the proposed project. The determination of significance is based on the approved SCAQMD significance thresholds (<http://www.aqmd.gov/docs/default-source/ceqa/handbook/scaqmd-air-quality-significance-thresholds.pdf?sfvrsn=2>), CEQA Guidelines (http://resources.ca.gov/ceqa/docs/2014_CEQA_Statutes_and_Guidelines.pdf), SCAQMD's 400-CEQA form (<http://www.aqmd.gov/docs/default-source/aqmd-forms/Permit/400-ceqa-form.pdf?sfvrsn=2>), and certain MDAQMD significance thresholds, where applicable.

2.1 GENERAL INFORMATION

Project Title:	Toxic Air Contaminant Reduction for Compliance with SCAQMD Rules 1420.1 and 1402 at the Exide Technologies Facility in Vernon, CA
Lead Agency Name:	South Coast Air Quality Management District
Lead Agency Address:	21865 Copley Drive, Diamond Bar, CA 91765
CEQA Contact Person:	Ms. Cynthia Carter, (909) 396-2431
Project Location:	Exide Technologies, 2700 South Indiana Street, Vernon, CA 90058
Project Sponsor's Name:	Exide Technologies
Project Sponsor's Address:	2700 South Indiana Street, Vernon, CA 90058
General Plan Designation:	Heavy Manufacturing
Zoning:	Zone M-2; No change to existing zoning, plans or other applicable land use controls are expected.
Description of Project:	Compliance with SCAQMD Rules 1420.1 and 1402 through the preparation of a RRP that requires the installation of new wet scrubber on the blast furnace air pollution control system; repurposed baghouse and a new RTO on the blast furnace charge hoods; a new RTO to be placed on the reverberatory furnace feed dryer stack; replacement of the reverberatory feed mechanism; enclosure of the blast furnace charge area; installation of charge level and temperature sensors in the blast furnace; changes to hoods and ducting related to the air pollution control systems modified by this project; and installation of a secondary HEPA filtration system downstream of the hard lead ventilation system baghouse.
Surrounding Land Uses and Setting:	The parcel is zoned for heavy Industrial (Zone M-2) and other parcels in the vicinity are zoned either Manufacturing or Commercial. The closest sensitive receptor is a residential receptor 1,400 meters to the north of the facility. The closest worker receptor is 100 meters to the north east of the facility.

Other Public Agencies Whose
Approval is Required:

City of Vernon – building (structural), plumbing, electrical,
traffic and fire permits.

2.2 ENVIRONMENTAL FACTORS POTENTIALLY AFFECTED

The following environmental impact issues have been assessed to determine their potential to be affected by the proposed project. As indicated by the checklist on the following pages, environmental topics marked with an "✓" may be adversely affected by the proposed project. An explanation relative to the determination of the significance of the impacts can be found following the checklist for each area.

- | | | |
|---|---|---|
| <input checked="" type="checkbox"/> Aesthetics | <input type="checkbox"/> Geology and Soils | <input type="checkbox"/> Population and Housing |
| <input type="checkbox"/> Agricultural Resources | <input checked="" type="checkbox"/> Hazards and Hazardous Materials | <input type="checkbox"/> Public Services |
| <input checked="" type="checkbox"/> Air Quality | <input checked="" type="checkbox"/> Hydrology and Water Quality | <input type="checkbox"/> Recreation |
| <input type="checkbox"/> Biological Resources | <input type="checkbox"/> Land Use and Planning | <input checked="" type="checkbox"/> Solid/Hazardous Waste |
| <input type="checkbox"/> Cultural Resources | <input type="checkbox"/> Mineral Resources | <input type="checkbox"/> Transportation/Traffic |
| <input checked="" type="checkbox"/> Energy | <input checked="" type="checkbox"/> Noise | <input checked="" type="checkbox"/> Mandatory Findings |

2.3 DETERMINATION

On the basis of this initial evaluation:

- I find the proposed project COULD NOT have a significant effect on the environment, and that a NEGATIVE DECLARATION will be prepared.
- I find that although the proposed project could have a significant effect on the environment, there will NOT be a significant effect because revisions in the project have been made by or agreed to by the project proponent. A MITIGATED NEGATIVE DECLARATION will be prepared.
- I find that the proposed project MAY have a significant effect(s) on the environment, and an ENVIRONMENTAL IMPACT REPORT will be prepared.
- I find that the proposed project MAY have a "potentially significant impact" or "potentially significant unless mitigated" impact on the environment, but at least one effect 1) has been adequately analyzed in an earlier document pursuant to applicable legal standards, and 2) has been addressed by mitigation measures based on the earlier analysis as described on attached sheets. An ENVIRONMENTAL IMPACT REPORT is required, but it must analyze only the effects that remain to be addressed.
- I find that although the proposed project could have a significant effect on the environment, because all potentially significant effects (a) have been analyzed adequately in an earlier EIR or NEGATIVE DECLARATION pursuant to applicable standards, and (b) have been avoided or mitigated pursuant to that earlier EIR or NEGATIVE DECLARATION, including revisions or mitigation measures that are imposed upon the proposed project, nothing further is required.

Date: October 15, 2014

Signature:



Michael Krause
Program Supervisor, CEQA Section
Planning, Rules, and Area Sources

2.4 DISCUSSION AND EVALUATION OF ENVIRONMENTAL IMPACTS

The Project Analyzed in the 2014 Final EA for Rule 1420.1

There are two facilities that are regulated by Rule 1420.1: the Quemetco facility in the City of Industry and the Exide facility in the City of Vernon. The project analyzed in the 2014 Final EA for Rule 1420.1 adopted on January 10, 2014 considered changes expected to be required at both facilities for rule compliance.

With respect to Exide, the CEQA analysis in the 2014 Final EA for Rule 1420.1 assumed that Exide would install a new RTO on the reverberatory furnace feed dryer stack to reduce benzene and 1-3 butadiene emissions, and replace the existing scrubber with a new scrubber or install a new wet ESP to reduce arsenic emissions associated with the reverberatory and blast furnaces in order to comply with the rule.

The RTO was expected to be installed without changes to the existing foundation. The old scrubber was expected to be recycled and the new scrubber installed in the same location on the existing foundation. Therefore, no soil disturbance was expected from the RTO installation or scrubber replacement.

Because of space issues, if needed, the new wet ESP for the furnaces was expected to be installed in the current location of a storm water retention pond. As such, the existing storm water retention pond was expected to be replaced with storm water storage tanks, which was expected to be installed where the temporary storm water storage tanks were placed at the time.

To comply with the amendments to Rule 1420.1, Exide was also expected to install differential pressure monitors, conduct ambient arsenic monitoring, conduct additional periodic source testing, and prepare additional reports and records. The installation of differential pressure monitors was not expected to require heavy construction equipment. Ambient arsenic monitoring was already occurring at the time and was not expected to generate any emissions or environmental impacts. Reporting and recordkeeping were expected to have negligible environmental impacts. The amendments to Rule 1420.1 required three additional source test events at both large lead-acid recycling facilities (a total of six additional source test events per year). Source testing was expected to require a single additional gasoline vehicle round trip on the day of source testing.

In order to ensure a proper analysis of the potential impacts from the amendments to Rule 1420.1, the environmental analysis included: the installation and operation of a new RTO, replacement and operation of a scrubber or installation and operation of a new wet ESP, the installation and operation of related support equipment, and the installation and operation of new wastewater storage tanks.

Proposed Project

The Exide facility needs to make changes from what was analyzed in the 2014 Final EA for Rule 1420.1 in order to comply with Rule 1420.1 and Rule 1402 requirements. The changes between the proposed project and the project analyzed in the 2014 Final EA for Rule 1420.1 were identified in the August 2014 proposed Revised Risk Reduction Plan for Rule 1402 and by permit applications submitted by Exide to comply with Rules 1402 and 1420.1. The proposed project description is presented in Chapter 1 of this Draft MND. Table 2-1 presents a summary

of the project description, compares the project description to the project analyzed in the 2014 Final EA for Rule 1420.1 and potential adverse impacts that are evaluated in the analysis within the Environmental Checklist below.

**Table 2-1
Elements Analyzed in the 2014 Final EA for Rule 1420.1 and Proposed Project Elements Evaluated in This Draft MND**

Proposed Project	Proposed Project Requirement	Was This Item Previously Analyzed in the 2014 Final EA for Rule 1420.1?	Proposed Project Potential Impacts
<p>Exide will install a new venturi and tray type wet scrubber (C203 and C202) that would be connected to the blast furnace APCS. The existing tray type (Neptune) scrubber (C43 and C42) will continue to service the reverberatory furnace. The existing Neptune scrubber stack and support structure would be replaced with a new stack and structure which would also service the new scrubber.</p>	<p>Rule 1402 (e), Rule 1420.1 (f), AB2588</p>	<p>Replacement and operation of a scrubber or installation and operation of a new wet electrostatic precipitator (ESP) were analyzed in the 2014 Final EA for Rule 1420.1.</p> <p>This MND evaluates the installation of the new venturi and tray type wet scrubber instead of replacing the existing scrubber.</p>	<p>Demolition of the Neptune scrubber stack and support structure would have been required if replaced by a scrubber or new wet ESP. Additional construction is expected to remove existing floor and underlying soil to for foundations for the new scrubber system. The additional construction may result in additional emissions, adverse hazards and hazardous waste, and adverse solid waste. The additional scrubber may have adverse energy, and adverse hydrology and water quality impacts</p>
<p>An existing but not operating baghouse (repurposed baghouse, Device C41) at the facility would be connected to the outlet of a new RTO(Device C205), and a new pre-filtering baghouse, venting the blast furnace charge hoods and thimble enclosure. The repurposed baghouse venting the RTO will be vented by the new scrubber to reduce the emissions of arsenic and SOx.</p>	<p>Rule 1402 (e), Rule 1420.1 (f), AB2588</p>	<p>Not analyzed in the 2014 Final EA for Rule 1420.1.</p> <p>This MND evaluates the new pre-filtering baghouse, repurposed baghouse, and the new RTO.</p>	<p>Additional construction is expected to remove the existing floor and underlying soil for the new RTO’s foundation. The additional construction may result in additional emissions, adverse hazards and hazardous waste, and adverse solid waste. The new RTO may increase secondary criteria emissions (TAC and GHG) and natural gas use.</p>

Table 2-1 (Continued)

Proposed Project	Proposed Project Requirement	Was This Item Analyzed in the 2014 Final EA for Rule 1420.1?	Proposed Project Potential Impacts
<p>The blast furnace thimble ventilation hoods previously connected to the hard lead ventilation system are being re-routed to the main APCS serving the blast furnace, which includes the new RTO (Device C205) and new scrubber (C203 and C202). The existing baghouse blower (250 brake horsepower (bhp)) would be replaced with a larger blower (450 bhp). A re-purposed baghouse, previously attached to the reverberatory furnace APCS, and now serving the blast furnace APCS, will also receive a new 450 bhp blower.</p>	<p>Rule 1402 (e), Rule 1420.1 (f), AB2588</p>	<p>Not analyzed in the 2014 Final EA for Rule 1420.1.</p> <p>The MND evaluates these changes including the new blower.</p>	<p>The additional construction may result in additional emissions. The larger blower horsepowers may have adverse energy impacts and the use of the baghouses would require disposal of filters, which may result in additional hauling emissions and adverse solid waste impacts.</p>
<p>The enclosure around the blast furnace charge area will be enhanced with additional ventilation air flow to serve as a secondary hood to capture gases escaping the charge isolation door by the hoods at the top of the enclosure.</p>	<p>Rule 1402 (e), Rule 1420.1 (f), AB2588</p>	<p>Not analyzed in the 2014 Final EA for Rule 1420.1.</p> <p>The MND evaluates the enclosure.</p>	<p>The additional construction may result in additional emissions. Changes would require additional blowers which may have adverse energy impacts.</p>
<p>Installation of a radar-based charge level sensor within the blast furnace and temperature sensor at the top of the blast furnace to measure the feed burden within the furnace.</p>	<p>Rule 1402 (e), Rule 1420.1 (f), AB2588</p>	<p>Not analyzed in the 2014 Final EA for Rule 1420.1.</p> <p>The MND evaluates the sensor.</p>	<p>The additional construction may result in additional emissions.</p>

Table 2-1 (Continued)

Proposed Project	Proposed Project Requirement	Was This Item Analyzed in the 2014 Final EA for Rule 1420.1?	Proposed Project Potential Impacts
The ventilation hood connected to the hard lead ventilation system serving the slag tap of the blast furnace would be enlarged and redirected to the new blast furnace baghouse that would be routed to the new scrubber (C203 and C202).	Rule 1402 (e), Rule 1420.1 (f), AB2588	Not analyzed in the 2014 Final EA for Rule 1420.1. The MND evaluates this change.	The additional construction may result in additional emissions.
The existing ram feeding mechanisms on the reverberatory furnace would be replaced with screw feeders to reduce the potential for arsenic and organic-bearing process gases to be drawn into the soft lead ventilation system pickup hood or discharged into the smelting building atmosphere.	Rule 1402 (e), Rule 1420.1 (f), AB2588	Not analyzed in the 2014 Final EA for Rule 1420.1. The MND evaluates the replacement of the feeding mechanism.	The additional construction may result in additional emissions. The change in feeding systems may have adverse energy impacts
The ventilation ducting serving two refining kettles would be removed from the hard lead ventilation system and redirected to the new blast furnace baghouse that would be routed to the new scrubber.	Rule 1402 (e), Rule 1420.1 (f), AB2588	Not analyzed in the 2014 Final EA for Rule 1420.1, The MND evaluates the new ducting.	The additional construction may result in additional emissions.

Table 2-1 (Concluded)

Proposed Project	Proposed Project Requirement	Was This Item Analyzed in the 2014 Final EA for Rule 1420.1?	Proposed Project Potential Impacts
<p>Another new RTO (Device C199) would be installed on the reverberatory furnace feed dryer APCS to reduce the emissions of toxic organic gases.</p>	<p>Rule 1402 (e), Rule 1420.1 (f), AB2588</p>	<p>Installation and operation of the RTO was analyzed in the 2014 Final EA for Rule 1420.1; however, the rating of the unit evaluate was smaller than the unit proposed by this project.</p> <p>The MND evaluates the increase in rating of the new RTO.</p>	<p>The currently proposed RTO is larger than the RTO evaluated in the Final EA. Additional construction is expected to remove the existing floor and underlying soil for the new RTO’s foundations. The additional construction may result in additional emissions, adverse hazards and hazardous waste, adverse solid waste and adverse geology and soils impacts. Changes would require additional natural gas combustion during operation, which may result in additional emissions and adverse energy impacts.</p>
<p>Secondary high efficiency particulate air (HEPA) filtration would be installed downstream of the MAC baghouses to reduce particulate emissions containing lead, arsenic and other toxic metals.</p>	<p>Rule 1402 (e), Rule 1420.1 (f), AB2588</p>	<p>Not analyzed in the 2014 Final EA for Rule 1420.1.</p> <p>This MND evaluates the new HEPA filtration.</p>	<p>The additional construction may result in additional emissions. Changes would require additional disposal of HEPA filters, which may result in additional hauling emissions and adverse solid waste impacts.</p>
<p>No additional wastewater tanks are required since the scrubber option has been chosen by Exide. New wastewater storage tanks were only expected if the stormwater retention pond would be replaced by a wet ESP.</p>	<p>Rule 1402 (e), Rule 1420.1 (f), AB2588</p>	<p>Installation and operation of new wastewater storage tanks were evaluated in the 2014 Final EA for Rule 1420.1.</p> <p>Since the stormwater retention pond is no longer part of the project, no wastewater tanks are needed. Therefore, no additional evaluation is needed.</p>	<p>Since new wastewater storage tanks would not be required, any related adverse impacts would be eliminated.</p>

	Potentially Significant Impact	Less Than Significant With Mitigation	Less Than Significant Impact	No Impact
I. AESTHETICS. Would the project:				
a) Have a substantial adverse effect on a scenic vista?	<input type="checkbox"/>	<input type="checkbox"/>	<input type="checkbox"/>	<input checked="" type="checkbox"/>
b) Substantially damage scenic resources, including, but not limited to, trees, rock outcroppings, and historic buildings within a state scenic highway?	<input type="checkbox"/>	<input type="checkbox"/>	<input type="checkbox"/>	<input checked="" type="checkbox"/>
c) Substantially degrade the existing visual character or quality of the site and its surroundings?	<input type="checkbox"/>	<input type="checkbox"/>	<input checked="" type="checkbox"/>	<input type="checkbox"/>
d) Create a new source of substantial light or glare which would adversely affect day or nighttime views in the area?	<input type="checkbox"/>	<input type="checkbox"/>	<input checked="" type="checkbox"/>	<input type="checkbox"/>

Significance Criteria

The proposed project impacts on aesthetics will be considered significant if:

- The project will block views from a scenic highway or corridor.
- The project will adversely affect the visual continuity of the surrounding area.
- The impacts on light and glare will be considered significant if the project adds lighting which would add glare to residential areas or sensitive receptors.

Discussion

I. a) & b) The proposed project affects the Exide facility located at 2700 South Indiana Street, Vernon, CA 90058 in the City of Vernon’s M-2 heavy industrial/warehousing zone and within the Rendering Overlay District, which allows operation of rendering plants, fertilizer plants and junk/salvage yards in addition to large lead-acid battery recycling facilities that are not located near scenic vistas, rock outcroppings, historical buildings or state scenic highways (DTSC, Exide Corporation Hazardous Waste Facility Permit Draft Environmental Impact Report, SCH No. 93051013, June 2006). The only trees near where control technologies and related support equipment may be installed are located on the outside of the facility and, thus, would not be affected by the proposed project. New control technologies and related support equipment would be installed within the affected facility. The control technology evaluated in the 2014 Final EA for Rule 1420.1 included replacement of an existing scrubber with a WESP or new scrubber, and a RTO. The proposed project would require a new scrubber on the blast furnace air pollution control system, a new RTO and repurposed baghouse on the blast furnace charge hoods, a new RTO to be placed on the reverberatory furnace feed dryer stack, replacement of the reverberatory feed mechanism, enclosure of the blast furnace charge area, installation of charge level and temperature sensors in the blast furnace, changes to hoods and ducting, and a installation of a secondary HEPA filtration system downstream of the hard lead ventilation system baghouse and the MAC feed room baghouse. The control technologies are expected to be installed within existing structures on–site with the exception of the new scrubber stack, stack supports and ducting, which are expected to be similar in visual characteristics to the existing

visible industrial equipment at the large lead-acid battery recycling facility. There are no plans to expand or modify the existing building, thus no changes to scenic vistas or other aesthetic resources. Therefore, the proposed project would not affect views of the trees from outside the affected facility. Therefore, the proposed project would not significantly affect scenic vistas or damage scenic resources.

I. c) In the 2014 Final EA for Rule 1420.1, the new replacement scrubber would be expected to be placed where the existing scrubber is removed. Under the proposed project, the existing Neptune scrubber would remain and the new scrubber would be installed; however, there is adequate space within the existing buildings to install air pollution control equipment without degrading the existing visual character. The 2014 Final EA for Rule 1420.1 also analyzed installing a wet ESP near the property boundary, which is no longer apart of the proposed project, so site surroundings would not change from the existing setting.

The proposed project would require a new scrubber on the blast furnace air pollution control system, a new RTO and repurposed baghouse on the blast furnace charge hoods, a new RTO to be placed on the reverberatory furnace feed dryer stack, replacement of the reverberatory feed mechanism, enclosure of the blast furnace charge area, installation of charge level and temperature sensors in the blast furnace, changes to hoods and ducting, and a installation of a secondary HEPA filtration system downstream of the hard lead ventilation system baghouse and the MAC feed room baghouse. Both scrubbers would be housed within an existing building; however the existing stack for the Neptune scrubber and its support structure would be replaced with a new stack and associated support structure that would service both scrubbers. The new scrubber stack would be the same height as the existing stack but have a slightly larger diameter. Therefore, the new stack and support structure is not expected to be visually similar to the exiting stack and associate support structure.

The new RTOs, enclosure of the furnace charge area, sensors, changes to hoods and ducting, enclosure of the furnace charge area, sensors, changes to hoods and ducting would also be housed within existing buildings, so these changes are not expected to be visible. Installation of these control technologies may require the installation of additional ducting, blowers and other air handling support equipment that were evaluated in the 2014 Final EA for Rule 1420.1 (see Figure 2-1 for the existing visual characteristic of the facility structure within which the new equipment would be housed.).

Installation of the air pollution control equipment and supporting structures may require the construction of temporary enclosures or the use of a crane, which may be visible from outside of the facility. The enclosures and construction equipment would be temporary (i.e., taken offsite after construction is finished), and therefore, are not expected to permanently alter the visual character or quality of the site and its surroundings. In addition, the temporary enclosures would hide construction work and reduce visible construction emissions, which would reduce adverse aesthetic construction impacts. Therefore, the proposed project is not expected to adversely affect the visual character or quality of the site and its surroundings.

As stated in the 2014 Final EA for Rule 1420.1, the existing neighborhood is highly industrial, with rail staging areas, industrial storage, storage tanks and power lines visible from the streets in adjacent facilities, as well as stacks, ducting and power lines on the affected facility property currently visible from the streets. So, while the scrubber stack and stack support structure may be visible from outside of the affected property (all other equipment would be placed within

existing structures and would not be seen from outside of the structures), it would not be inconsistent with views seen at adjacent facilities. Therefore, the proposed project would not add significant degradation to the existing visual character or quality of the site and its surroundings. On the contrary, with additional control technologies, emissions from visible particulate matter would be reduced and could provide more beneficial visual character.



Figure 2-1
View of the Existing Exide Facility

I. d) The proposed project may require operation of new control equipment and associated support equipment at night. The affected facility already operates at night and has lighting to support the existing operations so no new adverse impacts from lighting are expected. The surrounding area is industrial and other facilities also operate at night. Since most of the equipment would be placed within existing structures, additional exterior lighting is not expected. Any new lighting would be placed to illuminate the operations onsite and not directed off-site. Therefore, any additional lighting is expected to be similar to existing lighting onsite and at the industrial facilities nearby. Therefore, the proposed project is not expected to create a new source of substantial light or glare which would significantly adversely affect day or nighttime views in the area beyond current conditions.

Based upon the above considerations, the proposed project would not create new aesthetics impacts.

	Potentially Significant Impact	Less Than Significant With Mitigation	Less Than Significant Impact	No Impact
II. AGRICULTURE AND FOREST RESOURCES. Would the project:				
a) Convert Prime Farmland, Unique Farmland, or Farmland of Statewide Importance (Farmland), as shown on the maps prepared pursuant to the Farmland mapping and Monitoring Program of the California Resources Agency, to non- agricultural use?	<input type="checkbox"/>	<input type="checkbox"/>	<input type="checkbox"/>	<input checked="" type="checkbox"/>
b) Conflict with existing zoning for agricultural use, or a Williamson Act contract?	<input type="checkbox"/>	<input type="checkbox"/>	<input type="checkbox"/>	<input checked="" type="checkbox"/>
c) Conflict with existing zoning for, or cause rezoning of, forest land (as defined in Public Resources Code §12220(g)), timberland (as defined by Public Resources Code §4526), or timberland zoned Timberland Production (as defined by Government Code §51104 (g))?	<input type="checkbox"/>	<input type="checkbox"/>	<input type="checkbox"/>	<input checked="" type="checkbox"/>
d) Result in the loss of forest land or conversion of forest land to non-forest use?	<input type="checkbox"/>	<input type="checkbox"/>	<input type="checkbox"/>	<input checked="" type="checkbox"/>

Significance Criteria

Project-related impacts on agriculture and forest resources will be considered significant if any of the following conditions are met:

- The proposed project conflicts with existing zoning or agricultural use or Williamson Act contracts.
- The proposed project will convert prime farmland, unique farmland or farmland of statewide importance as shown on the maps prepared pursuant to the farmland mapping and monitoring program of the California Resources Agency, to non-agricultural use.
- The proposed project conflicts with existing zoning for, or causes rezoning of, forest land (as defined in Public Resources Code §12220(g)), timberland (as defined in Public Resources Code §4526), or timberland zoned Timberland Production (as defined by Government Code § 51104 (g)).
- The proposed project would involve changes in the existing environment, which due to their location or nature, could result in conversion of farmland to non-agricultural use or conversion of forest land to non-forest use.

Discussion

II. a) & b) In general, the affected facility and surrounding industrial areas are not located near areas zoned for agricultural use, Prime Farmland, Unique Farmland, or Farmland of Statewide Importance (Farmland), as shown on the maps prepared pursuant to the Farmland mapping and Monitoring Program of the California Natural Resources Agency. Therefore, the proposed project would not result in any construction of new buildings or other structures that would require converting farmland to non-agricultural use or conflict with zoning for agricultural use or a Williamson Act contract. Since the proposed project would not substantially change the facility or process at the facility, there are no provisions in the proposed project that would affect land use plans, policies, or regulations. Land use and other planning considerations are determined by local governments and no land use or planning requirements relative to agricultural resources would be altered by the proposed project.

IV. c) & d) The affected facility is located in an industrial area in the urban portion of Los Angeles County that is not near forest land. In addition, no new structures need to be built that require a conversion of forest land. Therefore, the proposed project is not expected to conflict with existing zoning for, or cause rezoning of, forest land (as defined in Public Resources Code §12220(g)), timberland (as defined by Public Resources Code §4526), or timberland zoned Timberland Production (as defined by Government Code §51104 (g)) or result in the loss of forest land or conversion of forest land to non-forest use.

Since the proposed project would not place affected equipment near farmland, the proposed project is not expected to result in converting farmland to non-agricultural use; or conflict with existing zoning for agricultural use, or a Williamson Act contract. Similarly, it is not expected that the proposed project would conflict with existing zoning for, or cause rezoning of, forest land; or result in the loss of forest land or conversion of forest land to non-forest use. Consequently, the proposed project would not create any significant adverse agriculture or forestry impacts.

	Potentially Significant Impact	Less Than Significant With Mitigation	Less Than Significant Impact	No Impact
III. AIR QUALITY AND GREENHOUSE GAS EMISSIONS				
Would the project:				
a) Conflict with or obstruct implementation of the applicable air quality plan?	<input type="checkbox"/>	<input type="checkbox"/>	<input checked="" type="checkbox"/>	<input type="checkbox"/>
b) Violate any air quality standard or contribute to an existing or projected air quality violation?	<input type="checkbox"/>	<input type="checkbox"/>	<input checked="" type="checkbox"/>	<input type="checkbox"/>
c) Result in a cumulatively considerable net increase of any criteria pollutant for which the project region is non-attainment under an applicable federal or state ambient air quality standard (including releasing emissions that exceed quantitative thresholds for ozone	<input type="checkbox"/>	<input type="checkbox"/>	<input checked="" type="checkbox"/>	<input type="checkbox"/>

precursors)?

	Potentially Significant Impact	Less Than Significant With Mitigation	Less Than Significant Impact	No Impact
d) Expose sensitive receptors to substantial pollutant concentrations?	<input type="checkbox"/>	<input checked="" type="checkbox"/>	<input type="checkbox"/>	<input type="checkbox"/>
e) Create objectionable odors affecting a substantial number of people?	<input type="checkbox"/>	<input type="checkbox"/>	<input checked="" type="checkbox"/>	<input type="checkbox"/>
f) Diminish an existing air quality rule or future compliance requirement resulting in a significant increase in air pollutant(s)?	<input type="checkbox"/>	<input type="checkbox"/>	<input checked="" type="checkbox"/>	<input type="checkbox"/>
g) Generate greenhouse gas emissions, either directly or indirectly, that may have a significant impact on the environment?	<input type="checkbox"/>	<input type="checkbox"/>	<input checked="" type="checkbox"/>	<input type="checkbox"/>
h) Conflict with an applicable plan, policy or regulation adopted for the purpose of reducing the emissions of greenhouse gases?	<input type="checkbox"/>	<input type="checkbox"/>	<input checked="" type="checkbox"/>	<input type="checkbox"/>

Significance Criteria

To determine whether or not air quality impacts from the proposed project may be significant, impacts will be evaluated and compared to the criteria in Table 2-2.

Discussion

III. a) The SCAQMD is required by law to prepare a comprehensive district-wide AQMP which includes strategies (e.g., control measures) to reduce emission levels to achieve and maintain state and federal ambient air quality standards, and to ensure that new sources of emissions are planned and operated to be consistent with the SCAQMD’s air quality goals. The AQMP’s air pollution reduction strategies include control measures which target stationary, area, mobile and indirect sources. These control measures are based on feasible methods of attaining ambient air quality standards. Pursuant to the provisions of both the state and federal CAAs, the SCAQMD is required to attain the state and federal ambient air quality standards for all criteria pollutants, including lead. The proposed project would not obstruct or conflict with the implementation of the AQMP because, arsenic, benzene, and 1,3-butadiene emission reductions are required by SCAQMD Rules 1401, 1420.1 and AB2588. The purpose of the proposed project is to ensure attainment of these regulatory requirements. The SCAQMD adopted the 2012 Lead State Implementation Plan (SIP) for Los Angeles County on May 4, 2012, which relies upon Rule 1420.1 for lead emission reductions. The SCAQMD also adopted amendments to Rule 1420.1 in January and March of 2014 that required emission limits for arsenic, benzene, and 1,3-butadiene. Further, on November 5, 2010, the Governing Board approved the 2010 Clean Communities Plan (CCP). The CCP is an update to the 2000 Air Toxics Control Plan (ATCP) and the 2004 Addendum. The objective of the 2010 CCP is to reduce the exposure to air toxics and air-related nuisances throughout the district, with emphasis on cumulative impacts. The elements of the 2010 CCP are community exposure reduction, community participation, communication and

outreach, agency coordination, monitoring and compliance, source-specific programs, and nuisance.

**TABLE 2-2
SCAQMD Air Quality Significance Thresholds**

<i>Mass Daily Thresholds^a</i>		
Pollutant	Construction^b	Operation^c
NOx	100 lbs/day	55 lbs/day
VOC	75 lbs/day	55 lbs/day
PM10	150 lbs/day	150 lbs/day
PM2.5	55 lbs/day	55 lbs/day
SOx	150 lbs/day	150 lbs/day
CO	550 lbs/day	550 lbs/day
Lead	3 lbs/day	3 lbs/day
<i>Toxic Air Contaminants (TACs), Odor, and GHG Thresholds</i>		
TACs (including carcinogens and non-carcinogens)	Maximum Incremental Cancer Risk \geq 10 in 1 million Cancer Burden $>$ 0.5 excess cancer cases (in areas \geq 1 in 1 million) Chronic & Acute Hazard Index \geq 1.0 (project increment)	
Odor	Project creates an odor nuisance pursuant to SCAQMD Rule 402	
GHG	10,000 MT/yr CO ₂ eq for industrial facilities	
<i>Ambient Air Quality Standards for Criteria Pollutants^d</i>		
NO₂ 1-hour average annual arithmetic mean	SCAQMD is in attainment; project is significant if it causes or contributes to an exceedance of the following attainment standards: 0.18 ppm (state) 0.03 ppm (state) and 0.0534 ppm (federal)	
PM10 24-hour average annual average	10.4 $\mu\text{g}/\text{m}^3$ (construction) ^e & 2.5 $\mu\text{g}/\text{m}^3$ (operation) 1.0 $\mu\text{g}/\text{m}^3$	
PM2.5 24-hour average	10.4 $\mu\text{g}/\text{m}^3$ (construction) ^e & 2.5 $\mu\text{g}/\text{m}^3$ (operation)	
SO₂ 1-hour average 24-hour average	0.25 ppm (state) & 0.075 ppm (federal – 99 th percentile) 0.04 ppm (state)	
Sulfate 24-hour average	25 $\mu\text{g}/\text{m}^3$ (state)	
CO 1-hour average 8-hour average	SCAQMD is in attainment; project is significant if it causes or contributes to an exceedance of the following attainment standards: 20 ppm (state) and 35 ppm (federal) 9.0 ppm (state/federal)	
Lead 30-day Average Rolling 3-month average Quarterly average	1.5 $\mu\text{g}/\text{m}^3$ (state) 0.15 $\mu\text{g}/\text{m}^3$ (federal) 1.5 $\mu\text{g}/\text{m}^3$ (federal)	

^a Source: SCAQMD CEQA Handbook (SCAQMD, 1993)

^b Construction thresholds apply to both the South Coast Air Basin and Coachella Valley (Salton Sea and Mojave Desert Air Basins).

^c For Coachella Valley, the mass daily thresholds for operation are the same as the construction thresholds.

^d Ambient air quality thresholds for criteria pollutants based on SCAQMD Rule 1303, Table A-2 unless otherwise stated.

^e Ambient air quality threshold based on SCAQMD Rule 403.

KEY: lbs/day = pounds per day ppm = parts per million $\mu\text{g}/\text{m}^3$ = microgram per cubic meter \geq = greater than or equal to
 MT/yr CO₂eq = metric tons per year of CO₂ equivalents $>$ = greater than

The proposed project would reduce arsenic, lead, benzene, and 1,3-butadiene emissions and therefore, are consistent with, and not conflict or obstruct implementation of the goals of the AQMP, 2012 Lead SIP for Los Angeles County, Rule 1402, Rule 1420.1, AB2588 and 2010 the CCP. Therefore, reducing arsenic, lead, benzene, and 1,3-butadiene emissions would not conflict or obstruct implementation of the 2012 Lead SIP for Los Angeles County, AQMP, Rule 1402, Rule 1420.1, AB2588 or 2010 CCP. Indirect GHG emissions are not expected to affect GHG reduction plans.

III. b) and f) *Criteria Pollutants*

Construction Impacts

Analysis in the 2014 Final EA for Rule 1420.1

The proposed project would reduce lead, arsenic and organic TACs, such as benzene and 1,3-butadiene emissions to ensure compliance with Rules 1402 and 1420.1. There are a variety of different engineering modifications and use of control equipment scenarios that Exide could use to achieve Rule 1402 health risk requirements and the emissions limits in Rule 1420.1. For the purpose of the CEQA analysis in the 2014 Final EA for Rule 1420.1, it was assumed that Exide would install a new RTO on the reverberatory furnace feed dryer stack to reduce benzene and 1-3 butadiene emissions, and replace the existing scrubber with a new scrubber or install a new wet ESP to reduce arsenic emissions associated with the reverberatory and blast furnaces. Criteria pollutant peak daily emissions from construction analyzed in the 2014 Final EA for Rule 1420.1 are presented in Table 2-3.

**Table 2-3
2014 Final EA for Rule 1420.1 Peak Daily Construction Emissions**

Construction Phase	CO, lb/day	NOx, lb/day	PM10, lb/day	PM2.5, lb/day	VOC, lb/day	SOx, lb/day
Demolition	29	75	5.2	3.0	4.4	0.04
Fill	28	73	7.5	3.4	6.4	0.1
Building	16	36	1.6	1.4	3.7	0.1
Paving	19	29	1.8	1.6	1.1	0.02
Significance Threshold, lb/day	550	100	150	55	75	150
Exceed Significance?	No	No	No	No	No	No

Source: SCAQMD, Final EA for Rule 1420.1, January 2014

Proposed Project

Exide’s Final RRP was reviewed and approved by SCAQMD on March 19, 2014. This plan was revised in August 2014 to include a new additional RTO and repurposed baghouse to be placed between the blast furnace charge hood and new scrubber. Exide submitted air quality permit applications based on the proposed Revised Final RRP. The proposed Revised Final RRP is analyzed in this Draft MND.

Therefore, the proposed Revised Final RRP for Rule 1402 includes the following:

- Additional RTO and repurposed baghouse to be placed between the blast furnace charge hood; and new scrubber on the blast furnace;
- New RTO to be placed on the reverberatory furnace feed dryer stack;
- Replacement of the reverberatory feed mechanism;
- Enclosure of the blast furnace charge area;

- Installation of charge level and temperature sensors in the blast furnace; changes to hoods and ducting;
- Installation of a secondary HEPA filtration system downstream of the hard lead ventilation system baghouse and the MAC feed room baghouse.

The proposed project would require less demolition than originally analyzed in the 2014 Final EA for Rule 1420.1 because there would be no demolition of the storm water retention pond. Exide has submitted permit applications for a new scrubber instead of replacing the existing scrubber with a larger scrubber or wet ESP. A crane was added in the analysis of the demolition phase. The purpose of the crane is to assist with the demolition of the existing scrubber stack and associated stack support structure. The amount of time construction equipment is used was also increased during the structure's building phase since more equipment is expected to be installed (e.g., installation of two RTOs, replacement of the reverberatory feed mechanism, enclosing of the furnace charge area, installation of charge level and temperature sensors, changes to hoods and ducting, and installation of a secondary HEPA filtration system downstream of the hard lead ventilation system baghouse and the MAC feed room baghouse).

Construction Phases

Construction is expected to occur in four phases: demolition, fill, paving and building of the structure. All the construction phases will take place on site and will generally need to be completed before moving on to the next phase.

Demolition Phase

The demolition phase would involve the demolition of flooring for new foundations for the new scrubber and RTOs, demolition of the existing scrubber stack and support structure and demolition of the ram feeding mechanism on the reverberatory furnace. The demolition would involve cranes, saws and loaders. All would occur within existing structures and within temporary enclosures with the exception of the demolition of the scrubber stack and support structure. A temporary scaffolding system would be built on the roof to enclose the scrubber stack and support structure. A one foot hole would be cut in the top of the temporary enclosure to allow the scrubber stack and support structure to be lowered by crane into the existing building. Dismantling of the stack and support structure would occur inside the existing building.

Soil beneath the Exide facility is contaminated with metals, primarily arsenic and lead. Trichloroethylene (TCE), Tetrachloroethylene (PCE), and other volatile organic compounds (VOCs) also have been identified in soils and groundwater beneath the facility. The proposed project will include removing some flooring and installing new foundations; hence, some earthwork is expected. Rule 1420.1 includes requirements for maintenance activities, which would include removal of ground pavement, concrete or asphalt associated with the proposed project. Specifically, it requires that the activity must be conducted in a partial enclosure using wet suppression, requires increased sampling and restricts construction during high wind conditions. These provisions will control fugitive dust.

In addition, excavation will be performed in the Baghouse Row enclosure which is required to be operated under negative pressure as indicated in the Construction and Activity Mitigation Plan approved by the SCAQMD Hearing Board through an Order for Abatement and which applies to maintenance activities, including this project. According to the Construction and Activity Mitigation Plan, all equipment demolition waste would be washed with potable water and placed

into a container for proper disposal or recycling. The scrap would be placed into a roll off container that is staged inside the total enclosure building the rolloff container would be covered when not in use and the exterior will be washed with potable water and tarped prior to removal to outside any enclosure buildings.

Also based on the Construction and Activity Mitigation Plan, prior to the removal of the existing floor and underlying soil to allow the installation of the foundation for the new scrubber system and RTOs, the existing floor would be thoroughly cleaned using HEPA vacuums followed by washing with potable water. The construction contractor would be required to use wet methods to minimize generation of dust when cutting concrete. During the concrete demolition (e.g. breaking up into small movable pieces) and removal activities, the removed concrete would be kept damp to minimize the generation of dust. Additional dust control would include applying a fine water mist directly on the demolition hammer point during the demolition activities. A fine water mist would also be applied to the concrete and soil as it is being excavated to minimize the generation of dust. All water used for washing the floor and other uses would be captured and treated properly to prevent a secondary means of fugitive emissions into the air.

The Construction and Activity Mitigation Plan states that the concrete and soil would be transferred into a rolloff container that is staged inside of the total enclosure building. The rolloff container would be covered when not in use and the exterior washed with potable water and tarped prior to removal outside any enclosure buildings. Exide plans to establish a decontamination zone that would be set up in a corridor in the baghouse row enclosure. Because of the limited size of the baghouse row enclosure only two rolloff containers can be placed within this area at a time. Based on the amount of time required to dismantle, decontaminate, and/or excavate that only two roll-off containers could be filled and sent off site per day.

The analysis in the 2014 Final EA for Rule 1420.1 assumed that demolition hazardous waste would be taken to either the Chemical Waste Management Kettleman Hills Landfill or the Clean Harbors Buttonwillow Landfill for treatment and disposal. Consistent with previous Exide projects, Exide's demolition material would be taken to Letvin Scrap Metal in Los Angeles if recyclable; or to Chiquita Canyon Sanitary Landfill in Castaic, California if non-hazardous; or to the Republic Services La Paz County Landfill in Parker, Arizona if considered a California hazardous waste; or to the US Ecology Inc., facility in Beatty, Nevada if considered RCRA hazardous waste.

- The distance from the Exide facility to Letvin Scrap Metal is 15 miles along the I-10 and I-710.
- The distance from the Exide facility to the Chiquita Canyon Sanitary Landfill in Castaic, California is 44 miles along the I-5.
- The distance from the Exide facility to the district border is 193 miles along the I-10 to Parker, Arizona. An additional 32.5 miles would be traveled through the Mojave Desert Air Pollution Control District (MDAQMD). The distance from the California border to the Republic Services La Paz County Landfill in Arizona is 1.5 miles.
- The distance from the Exide facility to the district border is 64 miles along the I-15 to Beatty, Nevada. An additional 157 miles would be traveled through the Mojave Desert Air Pollution Control District (MDAQMD). Approximately, 48 miles would be traveled across the Great Basin Unified Air Pollution Control District (GBUAPCD) The distance from the California border to the US Ecology Inc., facility in Beatty, Nevada is 36 miles.

Since the hazardous waste disposal facility would be determined by the level of contamination of the soil, which would not be known until the soil is tested; the analysis in this Draft MND assumed the longest distance to be traveled through each air district jurisdiction. In SCAQMD the miles would be 193 miles, 153 miles in MDAQMD and 52 miles in GBUAPCD, 1.5 miles in Arizona and 36 miles in Nevada (see Table 2-4). Since the truck trips originate in Los Angeles, emission factors from EMFAC2011 for the South Coast Air Basin were used to estimate emissions. The analysis estimates a maximum of two trips per day would be needed, so the longest distance traveled in each jurisdiction would generate the largest emissions for that jurisdiction. Emissions were estimated by jurisdiction because each jurisdiction has the ability to set its own significance criteria, and emissions should be compared to the jurisdiction where they are emitted.

**Table 2-4
Longest Distances Traveled by Hazardous Waste Haul Truck Used to Estimate Peak Emissions in Each Jurisdiction**

Jurisdiction	Distance Traveled to Republic Services La Paz County Landfill, Parker, Arizona, miles	Distance Traveled to US Ecology, Inc. Facility in Beatty Nevada, miles	Distance Traveled to Chiquita Canyon Sanitary Landfill in Castaic, California miles	Distance Traveled to Letvin Scrap Metal in Los Angeles, California	Maximum Distance Traveled in Each Jurisdiction Used for Peak Emissions Estimates
SCAQMD	193	64	45	15	193
MDAQMD	32.5	157			157
GBUAPCD		48			48
Arizona	1.5				1.5
Nevada		36			36
Total	227	305	44		Not Applicable

Fill Phase

The fill phase would involve the filling of the flooring with any soil needed to balance the area before paving. Backhoes would be used during the fill phase.

Paving Phase

The paving phase would involve the pouring of concrete for the new foundations for the new scrubber and new RTOs and any footings needed for the screw feeding mechanism on the reverberatory furnace. Concrete mixers would be used during this phase.

Structure Construction Phase

The structure construction phase would include the installation of air pollution control equipment and permanent enclosures (e.g., blast furnace feed area), installation of dampers, and the installation of the screw feeder system for the reverberatory furnace. Because the equipment would arrive on-site pre-manufactured, the construction impacts are from the delivery of the equipment and operation of a crane to install them. Loaders and forklifts are expected to be used during this phase.

The construction phases would be completed in the order described above because of logistics. The demolition of existing flooring, the existing scrubber stack, stack support structure, and ram feeding mechanism on the reverberatory furnace is required before, the new foundation and equipment is installed. The demolition areas may need to be filled with soil to balance the area before the new foundation and footings are poured for the new equipment. The structure construction phase can only be started after the foundations and footings are set. While one phase of construction will generally be completed before moving on to the next phase, it is possible that the end of one phase may overlap with the beginning of the next phase. Therefore, the peak daily emissions would occur when the adjacent phases with the greatest peak daily emissions overlap. The peak daily emissions would not necessarily be the sum of the two phases with greatest peak daily emissions, but the sum of the two adjacent phases with the greatest peak

daily emissions, because as stated above, the construction phases would occur in a certain logistical order as presented. For example, the flooring would need to be demolished before being repaved. The paving will need to be cured before the equipment is installed.

Construction emission estimates included construction equipment used during the phase (e.g., paver during paving) and on-road vehicles transporting workers, vendors, and material removal and delivery (see Appendix A). Peak daily construction criteria pollutant emissions from the proposed project are presented in Table 2-4, which are different from the peak daily criteria pollutant emissions from construction estimated in the 2014 Final EA for Rule 1420.1, which are presented in Table 2-3. In general, peak criteria emissions from the proposed project are less than those estimated in the 2014 Final EA for Rule 1420.1 because less demolition and fill is required since the wet ESP is no longer part of the project. The 2014 Final EA for Rule 1420.1 assumed as a worst-case scenario that the storm water retention pond would need to be removed to install a wet ESP. However, all the proposed project elements were considered in the peak daily construction emissions in Table 2-4. The end of one phase may overlap with the beginning of the next phase, so the peak daily emissions of each adjacent phase were summed and compared. The proposed project peak daily criteria pollutant emissions would occur when the paving and structure phases overlap.

Although CO (peak day increase of 2.7 lb/day), NO_x (peak day increase of 11.3 lb/day), and VOC (peak day increase of 0.6.4 lb/day) emissions are greater than those evaluated in the 2014 Final EA for Rule 1420.1, all daily criteria pollutant emissions from each construction phase were estimated to be below the SCAQMD significance thresholds for construction.

**Table 2-5
Proposed Project Peak Daily Construction Emissions (Onsite and Offsite) in SCAQMD**

Construction Phase	CO, lb/day	NO_x, lb/day	PM₁₀, lb/day	PM_{2.5}, lb/day	VOC, lb/day	SO_x, lb/day
Demolition	19	21	1.6	1.4	3.2	0.03
Fill	6.5	13	0.65	0.56	1.3	0.03
Paving	2.2	4.7	0.2	0.1	0.3	0.01
Structure	30	82	3.1	2.6	6.5	0.15
Peak Daily Emissions*	32	87	3.3	2.7	6.8	0.16
Significance Threshold	550	100	150	55	75	150
Exceed Significance?	No	No	No	No	No	No

*The peak daily of each phase was compared and the most emissions would occur if the paving and structure phases overlap.

Construction criteria pollutant emissions from the proposed project in MDAQMD are presented in Table 2-6. Only hazardous waste disposal trips (estimated to be a maximum of 2 truck roundtrips on any given day) in the demolition phase would generate emissions in MDAQMD since no other construction phases would occur outside of SCAQMD. All daily criteria pollutant emissions from the demolition phase were estimated to be below the MDAQMD significance thresholds for construction. Therefore, it was determined that construction related adverse criteria pollutant impacts in the MDAQMD would be less than significant.

**Table 2-6
Proposed Project Construction Criteria Pollutant Emissions in the MDAQMD Jurisdiction**

Description	CO	NO_x	PM₁₀	PM_{2.5}	VOC	SO_x
Daily Emissions, lb/day	2.5	11.4	0.34	0.24	0.49	0.023
Annual Emissions, ton/year	0.0188	0.085	0.0025	0.0018	0.0037	0.00017
MDAQMD Daily Significance Threshold, lb/day	548	137	82	82	137	137
MDAQMD Annual Significance Threshold, ton/year	100	25	15	15	25	25
Exceed Significance?	No	No	No	No	No	No

MDAQMD, Table 6 – Significant Emissions Thresholds, California Environmental Quality Act (CEQA) and Federal Conformity Guidelines, August 2011.

Potential construction criteria pollutant emissions from the proposed project in GBUAPCD are presented in Table 2-7. Only hazardous waste disposal trips during the demolition phase would generate potentially criteria pollutant emissions in GBUAPCD since no other construction phases would occur outside of SCAQMD. GBUAPCD does not have approved CEQA mass daily or annual significance thresholds other than compliance with Federal and State Ambient Air Quality Standards. As noted under the operational evaluation, Exide will comply with the localized significance thresholds that are based on attainment with the standards. In the absence of mass rate thresholds, the more conservative of the SCAQMD and MDAQMD mass significance thresholds were used as a surrogate for daily emissions and MDAQMD annual thresholds were used as a surrogate for annual significance thresholds (as the SCAQMD does not have an approved annual significance threshold). All daily criteria pollutant emissions from the demolition phase were estimated to be below the surrogate daily significance thresholds for construction. All annual criteria pollutant emissions from the demolition phase were estimated to be below the MDAQMD annual significance thresholds. Therefore, it was determined that construction related adverse criteria pollutant impacts in the GBUAPCD would be less than significant.

**Table 2-7
Proposed Project Construction Criteria Pollutant Emissions in the GBUAPCD Jurisdiction**

Description	CO	NO _x	PM ₁₀	PM _{2.5}	VOC	SO _x
Daily Emissions, lb/day	0.8	3.5	0.10	0.07	0.15	0.007
Annual Emissions, ton/year	0.0057	0.0261	0.0008	0.0006	0.0011	0.00005
Lower of SCAQMD or MDAQMD Daily Significance Threshold, lb/day	548	100	82	82	75	137
MDAQMD Annual Significance Threshold, ton/year	100	25	15	15	25	25
Exceed Significance?	No	No	No	No	No	No

GBUAPCD does not have CEQA thresholds other than the Federal and State Ambient Air Quality Standards. In the absence of mass rate thresholds, the lower of the SCAQMD and MDAQMD mass significance thresholds were used as a surrogate for daily emissions and MDAQMD annual thresholds were used as a surrogate for annual significance thresholds.

Potential construction criteria pollutant emissions from the proposed project in Arizona and Nevada are presented in Tables 2-8 and 2-9 respectively. Only hazardous waste disposal trips (estimated to be a maximum of 2 truck roundtrips on any given day) in the demolition phase would potentially generate criteria pollutant in Arizona or Nevada since no other construction phases would occur outside of SCAQMD. Because CEQA is a California program, it does not apply to Arizona or Nevada. However, because the proposed project would potentially generate trips into Arizona or Nevada to treat hazardous waste, criteria pollutant emissions from those truck trips were estimated. The most similar analyses to CEQA analyses prepared in Arizona and Nevada are National Environmental Policy Act (NEPA) analyses. Like CEQA, NEPA requires federal agencies to integrate environmental values into their decision making processes by considering the environmental impacts of their proposed actions and reasonable alternatives to those actions.

Arizona and Nevada NEPA analyses rely on Federal and State Ambient Air Quality Standards to evaluate adverse impacts. In the absence of mass rate thresholds, the lower of the SCAQMD and MDAQMD mass significance thresholds were used as a surrogate for daily emissions and MDAQMD annual thresholds were used as a surrogate for annual significance thresholds. All daily criteria pollutant emissions from the demolition phase in Arizona and Nevada were estimated to be below the surrogate daily significance thresholds for construction. All annual criteria pollutant emissions from the demolition phase were estimated to be below the MDAQMD annual significance thresholds. Therefore, it was determined that operational related adverse criteria pollutant impacts in Arizona and Nevada would be less than significant.

**Table 2-8
Proposed Project Construction Criteria Pollutant Emissions in Arizona**

Description	CO	NO_x	PM₁₀	PM_{2.5}	VOC	SO_x
Daily Emissions, lb/day	0.02	0.1	0.003	0.002	0.005	0.0002
Annual Emissions, ton/year	0.0002	0.0008	0.000024	0.00002	0.00004	0.000002
Lower of SCAQMD or MDAQMD Daily Significance Threshold, lb/day	548	100	82	82	75	137
MDAQMD Annual Significance Threshold, ton/year	100	25	15	15	25	25
Exceed Significance?	No	No	No	No	No	No

Arizona does not have significance thresholds other than the Federal Ambient Air Quality Standards. In the absence of mass rate thresholds, the lower of the SCAQMD and MDAQMD mass significance thresholds were used as a surrogate for daily emissions and MDAQMD annual thresholds were used as a surrogate for annual significance thresholds.

**Table 2-9
Proposed Project Construction Criteria Pollutant Emissions in Nevada**

Description	CO	NO_x	PM₁₀	PM_{2.5}	VOC	SO_x
Daily Emissions, lb/day	0.6	2.6	0.08	0.06	0.11	0.005
Annual Emissions, ton/year	0.0043	0.0196	0.0006	0.0004	0.0008	0.00004
Lower of SCAQMD or MDAQMD Daily Significance Threshold, lb/day	548	100	82	82	75	137
MDAQMD Annual Significance Threshold, ton/year	100	25	15	15	25	25
Exceed Significance?	No	No	No	No	No	No

Nevada does not have significance thresholds other than the Federal Ambient Air Quality Standards. In the absence of mass rate thresholds, the lower of the SCAQMD and MDAQMD mass significance thresholds were used as a surrogate for daily emissions and MDAQMD annual thresholds were used as a surrogate for annual significance thresholds.

Therefore, since daily criteria pollutant emissions from construction related to the proposed project are not expected to exceed the significance thresholds, construction impacts from the proposed project are not significant for criteria pollutant emissions.

In addition, as discussed in the Project Description in Chapter 1 of this Draft MND and earlier in this criteria pollutant analysis, Exide is required to implement fugitive dust methods in the Construction and Activity Mitigation Plan that would control fugitive metal dust.

Localized Significance Thresholds

The localized significance threshold (LST) methodology was developed to be used as a tool to assist lead agencies to analyze localized impacts associated with proposed projects. The LST

methodology and associated mass rates are not designed to evaluate localized impacts from mobile sources traveling over the roadways. LST lookup tables for one, two and five acre proposed projects emitting CO, NO_x, PM_{2.5}, and PM₁₀ were prepared for easy reference according to source receptor area.

The Exide facility is located in Source Receptor Area (SRA) 1 – Central Los Angeles. The proposed construction area is approximately one acre in area, except for the stack and associated stack support structure, and ducting; these will be enclosed within existing structures on-site. The furnace building is on the eastern side of the Exide facility along Indiana Street. The receptor distance between the building edge and the facility across the street is less than 25 meters. As discussed earlier, the end of one phase of construction may overlap with the beginning of the next phase. The peak daily of each phase was compared and the most emissions would occur if the demolition and fill phases overlap. On-site construction emissions and the one-acre LST significant thresholds for SRA 1 are presented in Table 2-10. Detailed construction emissions assumptions and calculations are presented in Appendix A. Since the emissions are below the one-acre LST significant thresholds for SRA 1, the proposed project is not expected generate construction criteria pollutant emissions that significantly impact sensitive receptors.

Table 2-10
Proposed Project Peak Daily On-site Construction Emissions

Description	CO, lb/day	NO _x , lb/day	PM ₁₀ , lb/day	PM _{2.5} , lb/day
Demolition	15	21	1.4	1.3
Fill	5.2	7.0	0.5	0.4
Paving	0.2	0.3	0.01	0.01
Building	19	34	1.7	1.6
Peak Daily Emissions*	17.2	28	1.9	1.7
Localized Significance Threshold at 100 meters	680	74	5.0	3.0
Exceed Significance?	NO	NO	NO	NO

*The end of one phase of construction may overlap with the beginning of the next phase. The peak daily of each phase was compared and the most emissions would occur if the demolition and fill phases overlap.

Operational Impacts

Analysis from the 2014 Final EA for Rule 1420.1

In the 2014 Final EA for Rule 1420.1, it was assumed that modifying the air handling systems and replacing an existing scrubber or installing a new wet ESP, would be needed to comply with Rule 1420.1 2014 amendments, and would not generate criteria pollutants. The modified air handling systems and these air pollution control equipment were expected to be powered by electricity, so no new combustion emissions from these pieces of equipment was expected to be generated. On the other hand, the RTO on the reverberatory furnace feed dryer stack was expected to generate criteria pollutants from the combustion of natural gas. Estimated operational criteria pollutant emissions from the 2014 Final EA for Rule 1420.1 are presented in Table 2-11.

Table 2-11
2014 Final EA for Rule 1420.1 Operational Criteria Pollutant Emissions

Description	CO, lb/day	NO _x , lb/day	PM ₁₀ , lb/day	PM _{2.5} , lb/day	VOC, lb/day	SO _x , lb/day
Regenerative Thermal Oxidizer	6.9	2.8	1.5	1.5	1.4	0.12
Source Test Trip	0.99	0.082	0.025	0.011	0.11	0.002
Spent Metal Disposal Trip	1.5	7.0	0.21	0.15	0.30	0.014
Total Operational Emissions	9.4	9.9	1.7	1.7	1.8	0.14
Significance Threshold	550	55	150	55	75	150
Exceed Significance?	No	No	No	No	No	No

Source: SCAQMD, Final EA for Rule 1420.1, January 2014

The amendments to Rule 1420.1 require three additional source test events at both large lead-acid recycling facilities (a total of six additional source test events per year). Additional source testing was expected to require an additional gasoline-fueled vehicle round trip to the facility on the day of source testing. Criteria pollutant emissions estimated from the additional gasoline-fueled vehicle trips are also presented in Table 2-11.

The affected facility currently sends operational hazardous waste to the Republic Services La Paz County Landfill in Arizona. The analysis in the 2014 Final EA for Rule 1420.1 assumed one additional haul truck trip to the Republic Services La Paz County Landfill per year (see Section XVI - Solid/Hazardous Waste of the 2014 Final EA for Rule 1420.1). Criteria emissions were based on a 193 mile round trip from the facility to the I-10 SCAQMD border, as shown in Table 2-11. Exide's operational criteria emissions would be less than the SCAQMD's mass daily operational significance thresholds; therefore, the 2014 amendments to Rule 1420.1 were not expected to result in significant adverse operational criteria pollutant emission impacts. Calculating the haul trucks' emissions to complete the trip across the I-10 through the Mojave Desert Air Quality Management District's (MDAQMD's) jurisdiction to the Arizona border, an additional distance of 32.5 miles was used. The single additional daily trip by haul trucks would generate criteria pollutant emissions that are less than the MDAQMD's significance thresholds (Table 2-12). Therefore, it was determined that operational related criteria pollutant emissions in the MDAQMD's jurisdiction would be less than significant for adverse operational criteria pollutant emission impacts in the accordance with the standards and thresholds for that area.

Table 2-12
2014 Final EA for Rule 1420.1 Operational Criteria Pollutant Emissions in the MDAQMD Jurisdiction

Description	CO	NO _x	PM ₁₀	PM _{2.5}	VOC	SO _x
Daily Emissions, lb/day	0.3	1.2	0.04	0.02	0.05	0.002
Annual Emissions, ton/year	0.0001	0.0006	0.00002	0.00001	0.00003	0.000001
MDAQMD Daily Significance Threshold, lb/day	548	137	82	82	137	137
MDAQMD Annual Significance Threshold, ton/year	100	25	15	15	25	25
Exceed Significance?	No	No	No	No	No	No

MDAQMD, Table 6 – Significant Emissions Thresholds, California Environmental Quality Act (CEQA) and Federal Conformity Guidelines, August 2011.

Proposed Project

The proposed project would require a new scrubber, two new RTOs, operation of a repurposed baghouse, replacement of the reverberatory feed mechanism, enclosure of the blast furnace charge area, installation of charge level and temperature sensors in the blast furnace, changes to hoods and ducting, and installation of a secondary HEPA filtration system downstream of the hard lead ventilation system baghouse and the MAC feed room baghouse.

With the exception of the new RTOs, other proposed equipment would be expected to be powered by electricity, so no new combustion emissions are expected to be generated from operation of these other pieces of equipment related to the proposed project. The new RTOs (4.6 million Btu per hour for the Cupola Thimble Hood and 2.5 million Btu per hour for the rotary dryer unit) would combust natural gas. Together the new RTOs (4.6 million Btu per hour and 2.5 million Btu per hour) would have a higher rating than the single RTO that was analyzed in the 2014 Final EA for Rule 1420.1 (1.58 million Btu per hour). Criteria pollutant emissions estimated from the additional natural gas combustion are presented in Table 2-13 and detailed in Appendix A.

Additional source testing would still be required, so emissions from an additional gasoline-fueled vehicle trip on the day of sources testing would remain the same. However, on a peak day, five delivery and haul truck roundtrips are estimated to be required to deliver and dispose additional filter media once a year. Two additional truck trips every four to five years would be needed to replace thermal ceramic media in the new RTOs. The source tests, disposal and replacement schedules are not directly correlated because of the different capacities of the streams and new equipment, so it is unlikely the source test, spent metal, replacement filter media or replacement thermal media trips would overlap on the same day.

Based on the number of trips and the distances to the disposal sites, the peak daily operation trip would be related to the filter media replacement. Assuming the HEPA filters and the baghouse filters are replaced at the same time, the worst-case operational diesel fuel use would be consumed during the five haul truck trips and five delivery truck trips related to filter disposal and replacement. The spent filters would be sent to the appropriate disposal site at either the

Republic Services La Paz County Landfill in Parker, Arizona (193 miles from Exide to the MDAQMD border) or the US Ecology, Inc., facility in Beatty, Nevada (64 miles from Exide to the MDAQMD border). Since all of the filters would be from the repurposed baghouse, all five trips would be sent to the same location. However, it is not known at this time whether the filters would be classified as California hazardous waste (sent to Parker, Arizona) or RCRA hazardous waste (sent to Beatty, Nevada). Such determination is made, similar to the construction criteria pollutant analysis, the longer of distance in each jurisdiction was used to estimate peak day emissions related to disposal of used filters as hazardous waste (See Table 2-4).

New filter delivery trucks were assumed to travel 40 miles one-way (80 miles round trip). Criteria pollutant emissions estimated from the additional diesel and gasoline-fueled vehicle trips are presented in Table 2-13 and detailed in Appendix A.

Table 2-13
Proposed Project Peak Daily Operational Criteria Pollutant Emissions

Description	CO, lb/day	NOx, lb/day	PM10, lb/day	PM2.5, lb/day	VOC, lb/day	SOx, lb/day
Dryer RTO	17.8	2.2	0.43	0.43	0.40	0.05
Cupola RTO	0.74	0.74	0.74	0.74	0.74	0.74
Filter Media Replacement	10.3	42.3	1.3	0.9	1.9	0.09
Total Operational Emissions	29	45	2.5	2.1	3.1	0.9
Regional Significance Threshold	550	55	150	55	75	150
Exceed Significance?	No	No	No	No	No	No

The operational criteria pollutant emissions from the proposed project would be greater than the operational criteria pollutant emissions from the project analyzed in the 2014 Final EA for Rule 1420.1 (increase of 20 lb/day of CO, 35 lb/day of NOx, 0.8 lb/day of PM10, 0.4 lb/day of PM2.5, 1.3 lb/day of VOC and 0.75 lb/day of SOx). The criteria pollutant emissions are greater because the amount of natural gas used by the new RTOs and the number of vehicle trips would be greater than was expected in the 2014 Final EA for Rule 1420.1. However, operational criteria emissions from the proposed project would still be less than the SCAQMD's mass daily operational significance thresholds; therefore, the proposed project is not expected to result in significant adverse operational criteria pollutant emission impacts.

In the 2014 Final EA for Rule 1420.1, it was assumed that haul trucks transporting spent lead and arsenic would travel 32.5 miles across the I-10 through the Mojave Desert Air Quality Management District's (MDAQMD's) jurisdiction to the Arizona border. However, California hazardous waste would be taken to the Republic Services La Paz County Facility in Parker Arizona. If waste is determined to be RCRA hazardous waste it would be taken to the US Ecology Inc., facility in Beatty, Nevada. The analysis in this Draft MND assumed the longest distance would be traveled through each air district jurisdiction, which would be 193 miles in SCAQMD, 153 miles in MDAQMD and 52 miles in GBUAPCD. From Exide's normal operations, the five additional daily haul trucks roundtrips in MDAQMD's jurisdiction would generate criteria pollutant emissions that are less than the MDAQMD's significance thresholds (Table 2-14). Therefore, it was determined that operational related criteria pollutant emissions in the MDAQMD's jurisdiction would be less than significant for adverse operational criteria pollutant emission impacts in the accordance with the standards and thresholds for that area.

**Table 2-14
Proposed Operational Criteria Pollutant Emissions in the MDAQMD Jurisdiction**

Description	CO	NO _x	PM ₁₀	PM _{2.5}	VOC	SO _x
Daily Emissions, lb/day	6.3	28.4	0.85	0.60	1.23	0.057
Annual Emissions, ton/year	0.0031	0.0142	0.00042	0.00030	0.00062	0.000029
MDAQMD Daily Significance Threshold, lb/day	548	137	82	82	137	137
MDAQMD Annual Significance Threshold, ton/year	100	25	15	15	25	25
Exceed Significance?	No	No	No	No	No	No

MDAQMD, Table 6 – Significant Emissions Thresholds, California Environmental Quality Act (CEQA) and Federal Conformity Guidelines, August 2011.

Potential operational criteria pollutant emissions from the proposed project related to five additional daily roundtrips by haul trucks in GBUAPCD are presented in Table 2-15. GBUAPCD does not have approved significance mass daily or annual significance thresholds other than the Federal and State Ambient Air Quality Standards. In the absence of mass rate thresholds, the lower of the SCAQMD and MDAQMD mass significance thresholds were used as a surrogate for daily criteria emissions significance thresholds and MDAQMD annual thresholds were used as a surrogate for annual significance thresholds. All daily criteria pollutant emissions from operation were estimated to be below the lower of the SCAQMD and MDAQMD daily significance thresholds for operation. All annual criteria pollutant emissions from the operation were estimated to be below the MDAQMD annual significance thresholds. Therefore, it was determined that adverse operational related criteria pollutant impacts in the GBUAPCD’s jurisdiction would be less than significant.

Table 2-15
Proposed Operational Criteria Pollutant Emissions in the GBUAPCD Jurisdiction

Description	CO	NO_x	PM₁₀	PM_{2.5}	VOC	SO_x
Daily Emissions, lb/day	1.9	8.7	0.26	0.18	0.38	0.017
Annual Emissions, ton/year	0.0010	0.0043	0.00013	0.00009	0.00019	0.000009
Lower of SCAQMD or MDAQMD Daily Significance Threshold, lb/day	548	75	55	55	55	137
MDAQMD Annual Significance Threshold, ton/year	100	25	15	15	25	25
Exceed Significance?	No	No	No	No	No	No

GBUAPCD does not have significance thresholds other than the Federal and State Ambient Air Quality Standards. In the absence of mass rate thresholds, the lower of the SCAQMD and MDAQMD mass significance thresholds were used as a surrogate for daily emissions and MDAQMD annual thresholds were used as a surrogate for annual significance thresholds.

Potential operational criteria pollutant emissions from the proposed project related to five additional daily trips by haul trucks in Arizona and Nevada are presented in Tables 2-16 and 2-17, respectively. Because CEQA is a California program it does not apply to Arizona or Nevada. However, because the proposed project would potentially generate trips into Arizona or Nevada to treat hazardous waste criteria pollutant emissions were estimated. The most similar analyses to a CEQA analysis prepared in Arizona and Nevada are National Environmental Policy Act (NEPA) analyses. Like CEQA, NEPA requires federal agencies to integrate environmental values into their decision making processes by considering the environmental impacts of their proposed actions and reasonable alternatives to those actions.

Arizona and Nevada NEPA analyses rely on Federal and State Ambient Air Quality Standards to evaluate adverse impacts. In the absence of mass rate thresholds, the more conservative of the SCAQMD and MDAQMD mass significance thresholds were used as a surrogate for daily criteria emissions significance thresholds and MDAQMD annual thresholds were used as a surrogate for annual significance thresholds. All daily criteria pollutant emissions from operation were estimated to be below the surrogate daily significance thresholds for construction. All annual criteria pollutant emissions from operation were estimated to be below the MDAQMD annual significance thresholds. Therefore, it was determined that operational related adverse criteria pollutant impacts in Arizona and Nevada would be less than significant.

Table 2-16
Proposed Operational Criteria Pollutant Emissions in Arizona

Description	CO	NO _x	PM ₁₀	PM _{2.5}	VOC	SO _x
Daily Emissions, lb/day	0.1	0.3	0.01	0.01	0.01	0.001
Annual Emissions, ton/year	0.0000	0.0001	0.00000	0.00000	0.00001	0.000000
Lower of SCAQMD or MDAQMD Daily Significance Threshold, lb/day	548	75	55	55	55	137
MDAQMD Annual Significance Threshold, ton/year	100	25	15	15	25	25
Exceed Significance?	No	No	No	No	No	No

Arizona NEPA analyses rely on Federal and State Ambient Air Quality Standards to evaluate adverse impacts. In the absence of mass rate thresholds, the lower of the SCAQMD and MDAQMD mass significance thresholds were used as a surrogate for daily emissions and MDAQMD annual thresholds were used as a surrogate for annual significance thresholds.

Table 2-17
Proposed Operational Criteria Pollutant Emissions in Nevada

Description	CO	NO _x	PM ₁₀	PM _{2.5}	VOC	SO _x
Daily Emissions, lb/day	1.4	6.5	0.19	0.14	0.28	0.013
Annual Emissions, ton/year	0.0007	0.0033	0.00010	0.00007	0.00014	0.000007
Lower of SCAQMD or MDAQMD Daily Significance Threshold, lb/day	548	75	55	55	55	137
MDAQMD Annual Significance Threshold, ton/year	100	25	15	15	25	25
Exceed Significance?	No	No	No	No	No	No

Nevada NEPA analyses rely on Federal and State Ambient Air Quality Standards to evaluate adverse impacts. In the absence of mass rate thresholds, the lower of the SCAQMD and MDAQMD mass significance thresholds were used as a surrogate for daily emissions and MDAQMD annual thresholds were used as a surrogate for annual significance thresholds.

Localized Significance Thresholds

The Exide facility is located in Source Receptor Area (SRA) 1 – Central Los Angeles. The proposed construction area at the Exide facility is approximately one acre in area and except for the stack and ducting enclosed within existing structures on-site. The furnace building is on the eastern side of the Exide facility along Indiana Street. The receptor distance between the stacks and the facility across the street is 100 meters. On-site operational emissions and the one-acre LST significance thresholds for SRA 1 are presented in Table 2-18. Detailed construction emissions assumptions and calculations are presented in Appendix A. Since the emissions are below the one-acre LST significant thresholds for SRA 1, the proposed project is not expected generate operational criteria pollutant emissions that significantly impact sensitive receptors.

Table 2-18
Proposed Project's On-site Operational Criteria Pollutant Emissions

Description	CO, lb/day	NOx, lb/day	PM10, lb/day	PM2.5, lb/day
Dryer RTO	17.8	2.2	0.43	0.43
Cupola RTO	0.74	0.74	0.74	0.74
Total On-site Operational Emissions	19	2.9	1.2	1.2
Localized Significance Threshold at 100 meters	1,259	82	8.0	3.0
Exceed Significance?	No	No	No	No

Indirect Criteria Pollutant Emissions from Electricity Consumption

The analysis in Section VI. Energy b), c) and d) of this document demonstrates that electricity generating facilities (EGFs) have sufficient capacity to account for the potential increased electricity consumption that may occur from implementing the proposed project. However, indirect criteria pollutant emissions would be created from the generation of electricity needed to supply power in order to operate electric construction equipment and new emissions control equipment as part of implementing the proposed project at the Exide facility, but these indirect emissions would occur off-site at the EGFs.

It is important to note that emissions from EGFs have been previously accounted for and evaluated in CEQA documents specific to the EGF projects at the time they were built or modified. NOx and SOx emissions from EGFs are regulated by SCAQMD's Regulation XX - Regional Clean Air Incentives Market (RECLAIM). Under the RECLAIM program, EGFs were provided annual allocations of NOx and SOx emissions that decline annually. For this reason, emissions that may be created from EGFs providing electricity specifically for the proposed project would not increase regional NOx and SOx emissions, since the overall NOx and SOx emissions generated by EGFs would need to remain within the existing regional annual NOx and SOx allocations under the RECLAIM program. Lastly, because the NOx and SOx emissions are limited by the annual RECLAIM allocations, the other criteria pollutants that may be generated from combustion activities associated with electricity generation (e.g., CO, VOC, PM10, and PM2.5) are also limited by stoichiometry. Therefore, the proposed project is not expected to increase indirect criteria emissions from EGFs supplying additional electricity to the Exide facility.

III. c) Cumulatively Considerable Impacts

The SCAQMD guidance on addressing cumulative impacts for air quality is as follows. "As Lead Agency, the AQMD uses the same significance thresholds for project specific and cumulative impacts for all environmental topics analyzed in an Environmental Assessment or EIR." "Projects that exceed the project-specific significance thresholds are considered by the SCAQMD to be cumulatively considerable. This is the reason project-specific and cumulative significance thresholds are the same. Conversely, projects that do not exceed the project-specific thresholds are generally not considered to be cumulatively significant."²

² SCAQMD Cumulative Impacts Working Group White Paper on Potential Control Strategies to Address Cumulative Impacts From Air Pollution, August 2003, Appendix D, Cumulative Impact Analysis Requirements Pursuant to CEQA, at D-3, <http://www.aqmd.gov/docs/default-source/Agendas/Environmental-Justice/cumulative-impacts-working-group/cumulative-impacts-white-paper-appendix.pdf?sfvrsn=4>.

This approach was upheld by the Court in *Citizens for Responsible Equitable Environmental Development v. City of Chula Vista* (2011) 197 Cal. App. 4th 327, 334. The Court determined that where it can be found that a project did not exceed the South Coast Air Quality Management District's established air quality significance thresholds, the City of Chula Vista properly concluded that the project would not cause a significant environmental effect, nor result in a cumulatively considerable increase in these pollutants. The court found this determination to be consistent with CEQA Guidelines §15064.7, stating, "The lead agency may rely on a threshold of significance standard to determine whether a project will cause a significant environmental effect." The court found that, "Although the project will contribute additional air pollutants to an existing nonattainment area, these increases are below the significance criteria..." "Thus, we conclude that no fair argument exists that the Project will cause a significant unavoidable cumulative contribution to an air quality impact." As in *Chula Vista*, here the District has demonstrated, when using accurate and appropriate data and assumptions, that the project will not exceed the established South Coast Air Quality Management District significance thresholds. See also, *Rialto Citizens for Responsible Growth v. City of Rialto* (2012) 208 Cal. App. 4th 899. Here again the court upheld the South Coast Air Quality Management District's approach to utilizing the established air quality significance thresholds to determine whether the impacts of a project would be cumulatively considerable. Thus, it may be concluded that the Project will not cause a significant unavoidable cumulative contribution to an air quality impact.

Based on the foregoing analysis, project-specific air quality impacts from implementing the proposed project would not exceed air quality significance thresholds (Table 2-1); therefore, based on the above discussion, cumulative impacts are not expected to be significant for air quality. Therefore, potential adverse impacts from the proposed project would not be "cumulatively considerable" as defined by CEQA Guidelines §15064(h)(1) for air quality impacts. Per CEQA Guidelines §15064(h)(4), the mere existing of significant cumulative impacts caused by other projects alone shall not constitute substantial evidence that the proposed project's incremental effects are cumulative considerable.

III. d) Toxic Air Contaminants

Construction

Construction TAC emissions may be generated from two sources: diesel exhaust emissions from heavy-duty trucks and construction equipment and from potential TAC emissions from contaminated soils.

Diesel exhaust particulate is considered a carcinogenic and chronic TAC. Since construction is expected to last less than two years and carcinogenic health risk is estimated over a 40 year exposure period for off-site occupational receptors and a 70 year exposure period for sensitive receptors, diesel exhaust particulate from construction is not expected to generate significant adverse health risk impacts.

Rule 1420.1 contains requirements for maintenance activity in subsection (i), which includes (c)(17)(e) resurfacing, repair, or removal of ground, pavement, concrete or asphalt. The maintenance requirements in subsection (i) state:

- 1) Beginning November 5, 2010, the owner or operator of a large lead-acid battery recycling facility shall conduct any maintenance activity in a negative air containment enclosure,

vented to a permitted negative air machine equipped with a filter(s) rated by the manufacturer to achieve a 99.97% capture efficiency for 0.3 micron particles, that encloses all affected areas where fugitive lead-dust generation potential exists, unless located within a total enclosure or approved by the Executive Officer. Any maintenance activity that cannot be conducted in a negative air containment enclosure due to physical constraints, limited accessibility, or safety issues when constructing or operating the enclosure shall be conducted:

- (A) In a partial enclosure, barring conditions posing physical constraints, limited accessibility, or safety issues;
- (B) Using wet suppression or a vacuum equipped with a filter(s) rated by the manufacturer to achieve a 99.97% capture efficiency for 0.3 micron particles, at locations where the potential to generate fugitive lead-dust exists prior to conducting and upon completion of the maintenance activity. Wet suppression or vacuuming shall also be conducted during the maintenance activity barring safety issues;
- (C) While collecting 24-hour samples at monitors for every day that maintenance activity is occurring notwithstanding paragraph (j)(2); and
- (D) Shall be stopped immediately when instantaneous wind speeds are > 25 mph. Maintenance work may be continued if it is necessary to prevent the release of lead emissions.

If soil is contaminated with VOC (including TACs that are VOC), the facility owners/operators would be required to prepare a SCAQMD Rule 1166 VOC Contaminated Soil Mitigation Plan. The mitigation plan would require that VOC emissions from the contaminated soil be controlled. Because demolition is expected to last less than a month and a SCAQMD Rule 1166 VOC Contaminated Soil Mitigation Plan would be required to be followed if VOC contaminated soil is found, significant adverse impacts from VOC TAC emissions associated with contaminated soil are also not expected.

The affected facility has previously been identified with soil contaminated with metals, primarily arsenic and lead. Trichloroethylene (TCE), tetrachloroethylene (PCE) and other volatile organic compounds (VOCs) contamination has also been identified. With the exception of replacing flooring in a building with a new foundation capable of supporting the new scrubber, no other excavation is expected. As stated earlier, based on the July 2014 Construction and Activity Mitigation Plan from the Order for Abatement (Case No. 3151-32), the flooring must be cleaned before demolition, so no contamination from the surface floor is expected. The construction contractor would saw the concrete using wet methods to minimize generation of dust. The concrete removed would be kept damp to minimize the generation of dust during the concrete demolition and removal activities. Additional dust control would include applying a fine water mist directly on the demolition hammer point during the demolition activities. A fine water mist would also be applied to the concrete and soil as it is being excavated to minimize the generation of dust. All water used for washing the floor and other uses would be captured and treated properly to prevent a secondary means of fugitive emissions into the air.

The July 2014 Construction Activity Mitigation Plan, approved by the Hearing Board, also requires active monitoring and the abatement of work activities if concentrations exceed permissible levels until a third party consultant can determine the cause of the adverse reading and mitigation is applied that reduces the concentrations to permissible levels. The July 2014 Construction Activity Mitigation Plan contemplated that an enhanced afterburner would be

installed. After consultation with SCAQMD staff in July 2014, Exide made a revision to the design. In this revised design, instead of enhancing the afterburner, the ventilation gases captured by the blast furnace charge hood would be treated separately from the blast furnace process gases. The ventilation gases from the charge enclosure at the top of the blast furnace would first pass through a cartridge filter to remove particulates before flowing through a new RTO. The new RTO would be in addition to and different from the other RTO to be placed on the reverberatory furnace feed stack. The treated ventilation gases would then be combined with the collected gases from the slag tap and the refining kettle hoods before being sent to the new blast furnace baghouse #2 air pollution control train (with subsequent wet scrubbing) for further emission control. As a result, the RRP was revised in August 2014. The proposed August 2014 amendments incorporate the charge hood's new RTO construction control requirements.

The August 2014 revision of the Final RRP has not yet been incorporated into the Construction Activity Mitigation Plan and approved by the SCAQMD Hearing Board for inclusion into the Order for Abatement (Case No. 3151-32). Since the July 2014 Construction Activity Plan does not include the RTO on the blast furnace charge hood, the construction and installation requirements for this RTO are included in this Draft MND as mitigation measures to ensure enforceability. The July 2014 Construction Activity Mitigation Plan is enforceable through the Hearing Board. Hence, mitigation measures, MMAQ-01 and MMAQ-02, have been crafted to reflect the August 2014 Construction Activity Mitigation Plan requirements for the blast furnace charge hood's new RTO construction.

MMAQ-01 – Prior to removal of the existing floor and underlying soil to allow installation of the foundations for the new Blast Furnace RTO and cartridge filter baghouse, Exide shall:

- Conduct activities within a building under negative pressure.
- Thoroughly clean the existing floor using HEPA vacuums followed by washing with potable water.
- Require the construction contractor to cut the concrete using wet methods to minimize generation of dust. The concrete being removed must be kept damp to minimize the generation of dust during the concrete demolition and removal activities.
- Apply a fine water mist directly on the demolition hammer point during the demolition activities and excavation activities.
- Capture and properly treat all water used for washing the floor and for other uses to prevent a secondary means of fugitive emissions into the air.

MMAQ-02 – Prior to the installation of the Blast Furnace RTO and cartridge filter baghouse, Exide shall:

- Conduct activities within a building under negative pressure.
- Wash all removed materials with potable water prior to placement into a container for proper offsite disposal or recycling.
- Place the scrap into a rolloff container that is staged inside of the total enclosure building.
- Cover the roll off container when not in use .
- Wash the exterior of the container with potable water and tarp the container prior to removal to outside of any enclosure buildings.

With the mitigation measures MMAQ-01 and MMAQ-02, construction TAC emissions are expected to be less than significant. All construction related activities to the new RTO would have the same construction controls as expected for the new RTO on the outlet of the rotary dryer, which was included in the July 2014 Construction Activity Mitigation Plan included Order

for Abatement (Case No. 3151-32) and is expected to ensure that concentrations remain within permissible levels by imposing the described requirements on the maintenance activity and the abatement of work activities, if concentrations exceed permissible levels.

Since mitigation measures (MMAQ-01 and MMAQ-02) are included as part of this proposed project, a mitigation monitoring plan will be developed pursuant to CEQA Guidelines §15074(d).

Construction TAC Cumulative Impacts

Based on the foregoing analysis the project-specific air quality impacts from implementing the proposed project would not exceed air quality significance thresholds with mitigation measures MMAQ-01 and MMAQ-02, cumulative impacts are not expected to be significant for air quality. Therefore, potential adverse impacts from the proposed project would not be "cumulatively considerable" as defined by CEQA Guidelines §15064(h)(1) for air quality impacts. Per CEQA Guidelines §15064(h)(4), the mere existing of significant cumulative impacts caused by other projects alone shall not constitute substantial evidence that the proposed project's incremental effects are cumulative considerable.

Operations

Direct Health Risk Reductions from Rule 1420.1 Requirements

Rule 1420.1 establishes emission limits for arsenic, benzene, and 1,3-butadiene, which are expected to reduce overall TAC emissions associated with large lead-acid battery recycling facilities. Paragraph (f)(2) of the rule requires the owner or operator of a large lead-acid battery recycling facility to vent emissions from all arsenic, benzene, and 1,3-butadiene point sources to an emission control device. Rule 1420.1 includes an interim compliance date for total facility point source emissions of arsenic because arsenic is the primary driver for the health risk impacts reported in the health risk assessment for Exide (90 percent for MICR, 100 percent of chronic hazard index, and 99 percent of acute hazard index). The interim standard for the total facility point source emissions of arsenic is 0.00285 pounds per hour (25 pounds per year) and is required to be met no later than 60 days after January 10, 2014 adoption of the amendments to Rule 1420.1. The final total facility point source mass emission standards are 0.00114 pounds per hour (10 pounds per year) for arsenic, 0.0514 pounds per hour (450 pounds per year) for benzene, and 0.00342 pounds per hour (30 pounds per year) for 1,3-butadiene and required to be met no later than January 1, 2015.

Exide prepared a health risk assessment per the AB 2588 program in February 2012. Due to requirements to perform additional source tests for emission sources at Exide, Exide modified and SCAQMD approved the health risk assessment in March 2013. The approved health risk assessment reported a maximum individual cancer risk of 156 in one million, a non-cancer chronic hazard index of 63, a non-cancer acute hazard index of 3.8, and a cancer burden of 10 triggering risk reduction requirements under Rule 1402. The maximum individual cancer risk is at a worker receptor. The health risk assessment showed that the primary risk drivers were arsenic, and to a lesser extent benzene and 1,3-butadiene. Pursuant to Rule 1402, Exide prepared and submitted a risk reduction plan to the SCAQMD on August 28, 2013. Exide submitted their Final Risk Reduction Plan on March 4, 2104 to address SCAQMD staff comments. The revised plan was reviewed and approved by SCAQMD staff on March 19, 2014.

In addition, SCAQMD staff modeled the impacts of the proposed emission rates in order to ensure compliance with Rule 1402 limits. The modeling results showed a maximum individual cancer risk of less than 10 in one million would occur for both facilities when the final Rule 1420.1 standards are met. Therefore, the facility's compliance with Rule 1420.1 is expected to have the benefit of reducing adverse health risk from 156 in one million to 10 in one million.

Exide submitted air quality permit applications based on the proposed Revised Final Risk Reduction plan which include a new scrubber, a new RTO to be placed on the reverberatory furnace feed dryer stack, new RTO for the blast furnace charge hood, replacement of the reverberatory feed mechanism, enclosure of the furnace charge area, installation of charge level and temperature sensors in the blast furnace, changes to hoods and ducting, and a installation of a secondary HEPA filtration system downstream of the hard lead ventilation system baghouse and the MAC feed room baghouse. These changes are expected to reduce TAC emissions to comply with Rules 1402 and 1420.1.

Health Risk Impacts from Rule 1420.1 ComplianceAnalysis from the 2014 Final EA for Rule 1420.1

In the 2014 Final EA for Rule 1420.1, the operation of modified air handling systems and the replacement scrubber or new ESP, which was expected to be needed to comply with the proposed amendments to Rule 1420.1, was not expected to generate any TAC emissions. The modified air handling systems, replacement scrubber or new wet ESP were expected to be powered by electricity, so no new combustion emissions were expected to be generated from these pieces of equipment. Modifications to the air handling system, replacement scrubber or new wet ESP were expected to reduce TAC emissions.

The RTO was expected to generate TAC emissions from the combustion of natural gas. TAC emissions (benzene, formaldehyde, and polycyclic aromatic hydrocarbons) from the RTO on the reverberatory furnace feed dryer stack were estimated using default natural gas external combustion emission factors from those listed on the SCAQMD's annual emission reporting forms. The closest sensitive receptor is a residential receptor 1,400 meters to the north of the facility. The closest worker receptor is 100 meters to the north east of the facility. TAC emissions related to natural gas combustion in the RTO were several orders of magnitude less than the screening values presented in Permit Package L of the SCAQMD Risk Assessment Procedures for Rules 1401 and 212 Version 7.0, December 2012 (see Table 2-19). Therefore, health risk from natural gas combustion in the RTO was expected to be less than significant for toxic air contaminant impacts.

Table 2-19
2014 Final EA for Rule 1420.1 Health Risk from Natural Gas Combustion

Pollutant	CAS No.	TAC ton/yr	TAC, lb/hr	Cancer/Chronic Screening Level at 100 meters, lb/yr	Acute Screening Level at 100 meters, lb/hr	Significant?
Benzene	71432	0.105	1.20E-05	8.92	3.96	No
Formaldehyde	50000	0.224	2.56E-05	0.425	0.147	No
PAHs	1151	5.26E-03	6.02E-07	7.69E-03	N/A	No

Source: SCAQMD, Final EA for Rule 1420.1, January 2014

TACs collected in the storm water were expected to be non-volatile (i.e., metals). The existing storm water retention pond is not covered, so storing storm water in storage tanks that are covered was expected to reduce TACs that are emitted as fugitive dust when the storm water evaporates from the existing storm water retention pond.

Proposed Project

With the exception of the two new RTOs, the modified air handling systems and air pollution control equipment is expected to be powered by electricity, so no new combustion emissions are expected to be generated by any other process related to the proposed project. The two new RTOs (4.6 million Btu per hour for the Cupola Thimble Hood and 2.5 million Btu per hour for the rotary dryer unit) would combust natural gas. The new RTOs (4.6 million Btu per hour and 2.5 million Btu per hour) would have a higher rating than that the single RTO analyzed in the

2014 Final EA for Rule 1420.1 (1.58 million Btu per hour). The RTOs would generate TAC emissions from the combustion of natural gas. TAC emissions (benzene, formaldehyde, polycyclic aromatic hydrocarbons (PAHs), naphthalene, acetaldehyde, acrolein, ammonia, ethyl benzene, hexane, toluene, and xylene) were estimated using natural gas external combustion emission factors used to evaluate the permit applications. The closest sensitive receptor is a residential receptor 1,400 meters to the north of the facility. The closest worker receptor is 100 meters to the north east of the facility. TAC emissions related to natural gas combustion in the RTOs would be several orders of magnitude less than the screening values presented in Permit Package L of the SCAQMD Risk Assessment Procedures for Rules 1401 and 212 Version 7.0, December 2012 (see Table 2-20). Risk Assessment Procedures for Rules 1401 and 212 Version 7.0, December 2012 multiple pollutant screening procedure states that if the sum of the emissions divided by the Table 1A screen level is less than one then additional analysis is not required (see Appendix A for detailed analysis). The summation of both the annual and daily emissions divided by Table 1A screen levels were less than one; therefore, health risk from natural gas combustion in the RTOs would be less than significant for toxic air contaminant impacts.

**Table 2-20
Proposed Project Health Risk from Natural Gas Combustion**

Pollutant	Cas No.	TAC, lb/yr	TAC, lb/hr	Screen Level at 100 meters, lb/yr	Screen Level at 100 meters, lb/hr	Significant?
Benzene	71432	0.473	5.41E-05	8.92	3.96	No
Formaldehyde	50000	1.00	1.15E-04	42.5	0.147	No
PAHs	1151	5.91E-03	6.76E-07	7.69E-03	N/A	No
Naphthalene	91203	0.0177	2.03E-06	7.44	N/A	No
Acetaldehyde	75070	0.254	2.91E-05	89.2	N/A	No
Acrolein	107028	0.159	1.83E-05	15.0	N/A	No
Ammonia	7664417	1.06E+03	0.122	5,170	8.57	No
Ethyl benzene	100414	0.561	6.42E-05	51,700	N/A	No
Hexane	110543	0.372	4.26E-05	1.81E+06	N/A	No
Toluene	108883	2.16	2.47E-04	77,500	99.1	No
Xylene	1330207	1.61	1.84E-04	1.81E+05	58.9	No

Proposed project operations may require thirteen additional truck trips annually (ten trips related to additional filter media replacement, one trip related to additional spent metal disposal and two trips related to replacement of thermal media). The receptors from a moving vehicle change as the vehicle travels, so health risk become small as the vehicle moves away. Health risk impacts can be determined from truck exhaust emissions from idling and on-site travel, which are similar in characteristics to those of a stationary source. Based on the short travel distance on-site, the state heavy-duty truck idling restriction of five minutes per event, three idling events, and emission factors from EMFAC2011, approximately 0.05 pounds of diesel exhaust PM per day would be emitted during the thirteen trips made per year $((15 \text{ min/hr} \times 7.16075 \text{ g/hr}) / (453.50 \text{ g/lb}) / (60 \text{ min/hr}) = 0.004 \text{ lb/trip} \times 13 \text{ trips})$, which is a several orders of magnitude less than the

screening value for diesel exhaust particulate of 1.39 pounds per day at 100 meters presented in Permit Package L of the SCAQMD Risk Assessment Procedures for Rules 1401 and 212 Version 7.0, December 2012. Therefore, on-site toxic air contaminant impacts from thirteen additional heavy-duty truck trips per year are expected to be negligible.

The operational TAC emissions from the proposed project would be larger than the operational TAC emissions from the project analyzed in the 2014 Final EA for Rule 1420.1. The operational TAC emissions are greater because the amount of natural gas used by the new RTOs would be greater than was expected in the 2014 Final EA for Rule 1420.1. However, operational TAC emissions from the proposed project would still be less than the SCAQMD's screening values as described in Table 2-20; therefore, the proposed project is not expected to result in significant adverse operational TAC emission impacts.

Therefore, since the health risk values from secondary TAC emissions related to the proposed project are less than the significance thresholds for health risk, and the proposed project is expected to lower existing health risk from 156 in one million to less than 10 in one million, the proposed project is not expected to be significant for adverse operational TAC emission impacts.

Based on the above discussion, exposing sensitive receptors to TAC emission concentrations from the proposed project is not expected to be significant.

III. e) Odor Impacts

Construction is expected to occur on-site at the Exide facility as a result of the proposed project. Also, the Exide facility is an industrial facility where heavy-duty diesel equipment (sweepers) and trucks already operate. Therefore, the addition of several pieces of construction equipment and haul trucks is not expected to generate substantially new diesel exhaust odor greater than what is already present.

Operation of a new scrubber, sensors, modified reverberatory feed mechanism, modified air handling systems, and a secondary HEPA filtration system is not expected to generate any new odors. These systems would not include any combustion and all would be designed to reduce TAC emissions at Exide, which may potentially further reduce odors.

The RTOs would generate new natural gas emissions, but the additional natural gas emissions are not expected to generate a noticeable increase in odor when compared to existing natural gas emissions from the furnaces, and refinery kettles dryers. In addition, the RTOs would control VOC and TAC emissions; thereby reducing odors.

The affected facility is an industrial facility where heavy-duty diesel equipment (sweepers) and trucks already operate. Thirteen additional heavy-duty diesel truck trips per year are not expected to generate a noticeable increase in odor.

Therefore, like the project analyzed in the 2014 Final EA for Rule 1420.1, the proposed project is not expected to generate significant adverse odor impacts.

III. g) and h) Greenhouse Gas Impacts

Global warming is the observed increase in average temperature of the earth's surface and atmosphere. The primary cause of global warming is an increase of greenhouse gas (GHG) emissions in the atmosphere. The six major types of GHG emissions are carbon dioxide (CO₂),

methane (CH₄), nitrous oxide (N₂O), sulfur hexafluoride (SF₆), hydrofluorocarbons (HFCs), and perfluorocarbons (PFCs). The GHG emissions absorb longwave radiant energy emitted by the earth, which warms the atmosphere. The GHGs also emit longwave radiation both upward to space and back down toward the surface of the earth. The downward part of this longwave radiation emitted by the atmosphere is known as the "greenhouse effect."

The current scientific consensus is that the majority of the observed warming over the last 50 years can be attributable to increased concentration of GHG emissions in the atmosphere due to human activities. Events and activities, such as the industrial revolution and the increased consumption of fossil fuels (e.g., combustion of gasoline, diesel, coal, etc.), have heavily contributed to the increase in atmospheric levels of GHG emissions. As reported by the California Energy Commission (CEC), California contributes 1.4 percent of the global and 6.2 percent of the national GHG emissions (CEC, 2004). Further, approximately 80 percent of GHG emissions in California are from fossil fuel combustion (e.g., gasoline, diesel, coal, etc.).

GHGs are typically reported as CO₂ equivalent emissions (CO₂e). CO₂e is the amount of CO₂ that would have the same global warming potential (relative measure of how much heat a greenhouse gas traps in the atmosphere) as a given mixture and amount of CO₂. CO₂e is estimated by the summation of mass of each GHG multiplied by its global warming potential (global warming potentials: CO₂ = 1, CH₄ = 21, N₂O = 310, etc. www.arb.ca.gov/cc/facts/conversiontable.pdf).

Construction

2014 Final EA for Rule 1420.1

Approximately 800 metric tons of CO₂e were expected to be generated from all construction activity including: demolition, fill, paving and construction of air handling and air pollution control systems and storm water storage tanks. The 2014 Final EA for Rule 1420.1 estimated that approximately 27 metric tons of CO₂e emissions per year would be generated from construction activities over the life of the project (30 years).

Proposed Project

Based on the same assumptions made for the criteria pollutant estimates, approximately 679 metric tons of CO₂e would be generated from all construction activity related to the proposed project including: demolition, fill, paving and construction of air handling and air pollution control systems in the SCAQMD. Amortized over 30 years as prescribed by the Interim CEQA GHG Significance Threshold for Stationary Sources, Rules and Plans³ adopted by the SCAQMD Governing Board in December 2008, approximately 23 metric tons of CO₂e emissions per year (see Appendix A) would be generated from construction activities over the life of the project.

As stated previously in the criteria pollutant analysis during the demolition phase, heavy-duty trucks would take concrete and soil determined to be hazardous waste to either Parker, Arizona or Beatty Nevada. The amount of CO₂e related to these trips in the MDAQMD would be 2,409 pounds per day and 18.1 tons per year.

³ Interim CEQA GHG Significance Threshold for Stationary Sources, Rules and Plans, <http://www.aqmd.gov/hb/2008/December/081231a.htm>.

The amount of potential CO₂e emissions related to demolition hazardous waste trips in the GBUAPCD would be 736 pounds per day and five metric tons per year (0.2 metric tons amortized over 30 years) during the demolition. Detailed GHG emissions calculations are included in Appendix A.

The amount of potential CO₂e emissions related to demolition hazardous waste trips in Arizona would be 23 pounds per day and 0.2 metric tons per year (0.005 metric tons amortized over 30 years) during the demolition. Detailed GHG emissions calculations are included in Appendix A. The amount of potential CO₂e emissions related to demolition hazardous waste trips in Nevada would be 552 pounds per day and 3.8 metric tons per year (0.1 metric tons amortized over 30 years) during the demolition. Detailed GHG emissions calculations are included in Appendix A.

Operation

Direct GHG Emissions

2014 Final EA for Rule 1420.1

The operation of the air handling system, replacement scrubber or new wet ESP was not expected to generate greenhouse gases as the equipment was expected to control emission with no secondary emissions impacts. The operation of storm water storage tanks in place of the existing storm water retention ponds was not expected to generate any additional greenhouse gases beyond what was generated by the existing ponds. The combustion of natural gas in the RTO for the reverberatory furnace feed dryer stack was expected to generate 717 metric tons of CO₂e per year.

The 2014 Final EA for Rule 1420.1 assumed that three additional source test events at both large lead-acid recycling facilities (a total of six additional source test events). One additional truck trip per year may be needed to transport spent arsenic and lead to a hazardous waste disposal facility. One additional truck round trip per year from the affected facility to the I-10 district boundary and six gasoline-fueled vehicle round trips would generate 0.75 metric tons of CO₂e emissions in the district, and 0.1 ton per year (249 pounds per day) in the MDAQMD.

Proposed Project

The proposed project consist of operation of a new scrubber, sensors, a modified reverberatory feed mechanism, modified air handling systems, and a secondary HEPA filtration system which is not expected to directly generate any new greenhouse gases, as the equipment control emissions without generating secondary emissions on-site. Indirect GHG emissions generated off-site by electricity production are addressed below (see Indirect GHG Emission from Electricity Production).

The combustion of natural gas in the new RTOs would generate 3,330 metric tons of CO₂e per year (see Appendix A). Proposed project operations may require thirteen additional truck trips annually (ten trips related to additional filter media replacement, one trip related to additional spent metal disposal and two trip related to replacement of thermal media) and three gasoline fuel vehicle source test trips. Thirteen additional truck trips and six gasoline fuel vehicle source test trips per year would generate 9.5 metric tons of CO₂e emissions in the district, 7.8 metric tons per year in the MDAQMD. The amount of potential CO₂e emissions related to operational hazardous waste trips in the MDAQMD would be 6,022 pounds per day and 7.8 tons per year. The amount of potential CO₂e emissions related to operational hazardous waste trips in the

GBUAPCD would be 1,841 pounds per day and 2.8 metric tons per year. The amount of potential CO₂e emissions related to operational hazardous waste trips in Arizona would be 58 pounds per day and 0.1 metric tons per year. The amount of potential CO₂e emissions related to operational hazardous waste trips in Nevada would be 1,381 pounds per day and 1.6 metric tons per year.

Total Project GHG Emissions

The proposed project may result in the generation of 23 amortized metric tons of CO₂e construction emissions per year and 3,363 (3,340 + 23) metric tons of CO₂e operational emissions per year. The addition of 3,363 metric tons of CO₂e emissions is greater than the 745 metric tons of CO₂e estimated in the 2014 Final EA for Rule 1420.1, but still less than the SCAQMD significance threshold of 10,000 metric tons per year for CO₂e from industrial projects.

The proposed project may result in the generation of 2,409 pounds per day and 18 tons per year during construction; and 6,022 pounds per day and 7.8 tons per year of CO₂e operational emissions in the MDAQMD. Since construction and operational trips in the MDAQMD are not expected to occur on the same day in the same year, construction and operational GHG emissions were not added together. This is than the more than the 0.1 ton per year estimated in the 2014 Final EA for Rule 1420.1, but both construction and operational GHG emissions are less than the MDAQMD GHG thresholds of 100,000 tons per year and 548,000 pounds per day (MDAQMD, Table 6 – Significant Emissions Thresholds, California Environmental Quality Act (CEQA) and Federal Conformity Guidelines, August 2011).

As stated in the criteria pollutant analysis above GBUAPCD, Arizona and Nevada do not have mass daily or annual rate significance thresholds. So, the annual SCAQMD GHG significance threshold (10,000 metric tons per year) was used as a surrogate because it was is less than the annual MDAQMD GHG significance threshold of (100,000 tons per year). The daily MDAQMD GHG significance threshold was used as a surrogate because the SCAQMD, GBUAPCD, Arizona and Nevada do not have daily GHG significance thresholds.

The amount of potential CO₂e emissions related to demolition hazardous waste trips in the GBUAPCD would be 736 pounds per day and five metric tons per year (0.2 metric tons amortized over 30 years) during the demolition. The amount of potential CO₂e emissions related to operational hazardous waste trips in the GBUAPCD would be 1,841 pounds per day and 2.8 metric tons per year. Both 736 pounds of CO₂e per day during construction and 1,841 pounds of CO₂e per day during operation are below the MDAQMD significance thresholds of 548,000 pounds per day. The 2.4 metric tons per year (0.2 metric tons of CO₂e amortized over 30 years from construction + 2.2 metric tons of CO₂e per year from operation) is less than the SCAQMD significance threshold of 10,000 metric tons per year. Detailed GHG emissions calculations are included in Appendix A. Therefore, potential GHG emissions in the GBUAPCD the proposed project are expected to be less than significant.

The amount of potential CO₂e emissions related to demolition hazardous waste trips in Arizona would be 23 pounds per day and 0.2 metric tons per year (0.01 metric tons amortized over 30 years) during the demolition. The amount of potential CO₂e emissions related to operational hazardous waste trips in Arizona would be 58 pounds per day and 0.1 metric tons per year. Both 23 pounds of CO₂e per day during construction and 58 pounds of CO₂e per day during operation are below the MDAQMD daily GHG significance thresholds of 548,000 pounds per day. The 0.2 metric tons per year (0.01 metric tons of CO₂e amortized over 30 years from construction +

0.1 metric tons of CO₂e per year from operation) is less than the SCAQMD annual GHG significance threshold of 10,000 metric tons per year. Detailed GHG emissions calculations are included in Appendix A. Therefore, potential GHG emissions from the proposed project in Arizona are expected to be less than significant.

The amount of potential CO₂e emissions related to demolition hazardous waste trips in Nevada would be 552 pounds per day and 3.8 metric tons per year (0.1 metric tons amortized over 30 years) during the demolition. The amount of potential CO₂e emissions related to operational hazardous waste trips in Nevada would be 1,381 pounds per day and 1.6 metric tons per year. Both 552 pounds of CO₂e per day during construction and 1,381 pounds of CO₂e per day during operation are below the MDAQMD daily GHG significance thresholds of 548,000 pounds per day. The 1.7 metric tons per year (0.1 metric tons of CO₂e amortized over 30 years from construction + 1.6 metric tons of CO₂e per year from operation) is less than the SCAQMD annual GHG significance threshold of 10,000 metric tons per year. Detailed GHG emissions calculations are included in Appendix A. Therefore, potential GHG emissions the proposed project in Nevada are expected to be less than significant.

Indirect GHG Emissions from Electricity Production

Indirect GHG emissions from the generation of electricity to operate new equipment occur off-site at electricity generating facilities (EGFs). Emissions from electricity generating facilities are already evaluated in the CEQA documents for those projects when they are built or modified. The analysis in Section VI. Energy b), c) and d) of this document demonstrates that there is sufficient capacity from power providers for the increased electricity consumption from the proposed project. In addition, power producers are subject to the California Cap on Greenhouse Gas Emissions and Market-Based Compliance Mechanisms Program that took effect in early 2012. The enforceable compliance obligation began on January 1, 2013, for GHG emissions. Under this program, power producers report their annual GHG emissions and are required to buy GHG emission credits on the open market. The price of buying these credits is reflected in the rates that consumers pay. Since GHG emissions in California are capped by this program, any new indirect GHG emission generated by power producers by electricity used for the proposed project must be offset by the purchase of GHG emission credits. Therefore, any indirect GHG emissions would be offset by the California Cap on Greenhouse Gas Emissions and Market-Based Compliance Mechanisms Program. Therefore, the proposed project is not expected to affect GHG plans, policy or regulations adopted for the purpose of reducing the emissions of GHG gases.

Therefore, like the amendments to Rule 1420.1, the proposed project is not expected to generate GHG emission, either directly or indirectly, that may have a significant impact on the environment no conflict with an applicable plan, policy or regulation adopted for the purpose of reducing the emissions of GHG gases.

Conclusion

Based upon these considerations, the proposed project would not generate significant adverse construction or operational air quality impacts with mitigation.

	Potentially Significant Impact	Less Than Significant With Mitigation	Less Than Significant Impact	No Impact
IV. BIOLOGICAL RESOURCES.				
Would the project:				
a) Have a substantial adverse effect, either directly or through habitat modifications, on any species identified as a candidate, sensitive, or special status species in local or regional plans, policies, or regulations, or by the California Department of Fish and Game or U.S. Fish and Wildlife Service?	<input type="checkbox"/>	<input type="checkbox"/>	<input type="checkbox"/>	<input checked="" type="checkbox"/>
b) Have a substantial adverse effect on any riparian habitat or other sensitive natural community identified in local or regional plans, policies, or regulations, or by the California Department of Fish and Game or U.S. Fish and Wildlife Service?	<input type="checkbox"/>	<input type="checkbox"/>	<input type="checkbox"/>	<input checked="" type="checkbox"/>
c) Have a substantial adverse effect on federally protected wetlands as defined by §404 of the Clean Water Act (including, but not limited to, marsh, vernal pool, coastal, etc.) through direct removal, filling, hydrological interruption, or other means?	<input type="checkbox"/>	<input type="checkbox"/>	<input type="checkbox"/>	<input checked="" type="checkbox"/>
d) Interfere substantially with the movement of any native resident or migratory fish or wildlife species or with established native resident or migratory wildlife corridors, or impede the use of native wildlife nursery sites?	<input type="checkbox"/>	<input type="checkbox"/>	<input type="checkbox"/>	<input checked="" type="checkbox"/>
e) Conflict with any local policies or ordinances protecting biological resources, such as a tree preservation policy or ordinance?	<input type="checkbox"/>	<input type="checkbox"/>	<input type="checkbox"/>	<input checked="" type="checkbox"/>
f) Conflict with the provisions of an	<input type="checkbox"/>	<input type="checkbox"/>	<input type="checkbox"/>	<input checked="" type="checkbox"/>

adopted Habitat Conservation plan, Natural Community Conservation Plan, or other approved local, regional, or state habitat conservation plan?

Significance Criteria

Impacts on biological resources will be considered significant if any of the following criteria apply:

- The project results in a loss of plant communities or animal habitat considered to be rare, threatened or endangered by federal, state or local agencies.
- The project interferes substantially with the movement of any resident or migratory wildlife species.
- The project adversely affects aquatic communities through construction or operation of the project.

Discussion

IV. a), b), c), d), e) & f) In the 2014 Final EA for Rule 1420.1, the new replacement scrubber would be expected to be placed where the existing scrubber is removed. Under the proposed project, the existing Neptune scrubber would remain and the new scrubber would be installed. The 2014 Final EA for Rule 1420.1 also analyzed installing a wet ESP near the property boundary, which is no longer apart of the proposed project.

The proposed project would require a new scrubber on the blast furnace air pollution control system, a new RTO and repurposed baghouse on the blast furnace charge hoods, a new RTO to be placed on the reverberatory furnace feed dryer stack, replacement of the reverberatory feed mechanism, enclosure of the blast furnace charge area, installation of charge level and temperature sensors in the blast furnace, changes to hoods and ducting, and a installation of a secondary HEPA filtration system downstream of the hard lead ventilation system baghouse and the MAC feed room baghouse.

In general, the affected facility and surrounding industrial areas currently do not support riparian habitat, federally protected wetlands, or migratory corridors because they are long developed and established foundations used for industrial purposes. Additionally, special status plants, animals, or natural communities identified in local or regional plans, policies, or regulations, or by the California Department of Fish and Game or U.S. Fish and Wildlife Service are not expected to be found in close proximity to the affected facility. Therefore, the proposed project would have no direct or indirect impacts that could adversely affect plant or animal species or the habitats on which they rely in the SCAQMD's jurisdiction.

Compliance with the proposed project is expected to reduce arsenic, lead, benzene, and 1,3-butadiene emissions from operations at the affected facility, which would improve, not worsen, present conditions of plant and animal life, since these TAC emissions would be captured and destroyed or disposed of properly before they impact plant and animal life. The proposed project does not require acquisition of additional land or further conversions of riparian habitats or sensitive natural communities where endangered or sensitive species may be found.

The proposed project is not envisioned to conflict with local policies or ordinances protecting biological resources or local, regional, or state conservation plans because it is only expected to affect Exide's large lead-acid battery recycling facility located in Vernon. The proposed project

is designed to reduce arsenic, lead, benzene, and 1,3-butadiene emissions, which would also reduce emissions both inside and outside the boundaries of the affected facility and, therefore, more closely in line with protecting biological resources. Land use and other planning considerations are determined by local governments and no land use or planning requirements would be altered by the proposed project. Additionally, the proposed project would not conflict with any adopted Habitat Conservation Plan, Natural Community Conservation Plan, or any other relevant habitat conservation plan, and would not create divisions in any existing communities because all activities associated with complying with proposed project would occur at existing established industrial facilities.

The SCAQMD, as the Lead Agency for the proposed project, has found that, when considering the record as a whole, there is no evidence that the proposed project will have the potential for any new adverse effects on wildlife resources or the habitat upon which wildlife depends because all activities needed to comply with the proposed project would take place at long developed and established facilities. Accordingly, based upon the preceding information, the SCAQMD has, on the basis of substantial evidence, rebutted the presumption of adverse effect contained in §753.5 (d), Title 14 of the California Code of Regulations. Further, in accordance with this conclusion, the SCAQMD believes that this proposed project qualifies for the no effect determination pursuant to Fish and Game Code §711.4 (c).

Based upon these considerations, significant adverse biological resources impacts are not anticipated.

	Potentially Significant Impact	Less Than Significant With Mitigation	Less Than Significant Impact	No Impact
V. CULTURAL RESOURCES. Would the project:				
a) Cause a substantial adverse change in the significance of a historical resource as defined in §15064.5?	<input type="checkbox"/>	<input type="checkbox"/>	<input type="checkbox"/>	<input checked="" type="checkbox"/>
b) Cause a substantial adverse change in the significance of an archaeological resource as defined in §15064.5?	<input type="checkbox"/>	<input type="checkbox"/>	<input type="checkbox"/>	<input checked="" type="checkbox"/>
c) Directly or indirectly destroy a unique paleontological resource, site, or feature?	<input type="checkbox"/>	<input type="checkbox"/>	<input type="checkbox"/>	<input checked="" type="checkbox"/>
d) Disturb any human remains, including those interred outside formal cemeteries?	<input type="checkbox"/>	<input type="checkbox"/>	<input type="checkbox"/>	<input checked="" type="checkbox"/>

Significance Criteria

Impacts to cultural resources will be considered significant if:

- The project results in the disturbance of a significant prehistoric or historic archaeological site or a property of historic or cultural significance to a community or ethnic or social group.
- Unique paleontological resources are present that could be disturbed by construction of the proposed project.
- The project would disturb human remains.

Discussion

V. a), b), c), & d) In the 2014 Final EA for Rule 1420.1, the new replacement scrubber would be expected to be placed where the existing scrubber is removed. Under the proposed project, the existing Neptune scrubber would remain and the new scrubber would be installed. The 2014 Final EA for Rule 1420.1 also analyzed installing a wet ESP near the property boundary, which is no longer apart of the proposed project.

The proposed project would require a new scrubber on the blast furnace air pollution control system, a new RTO and repurposed baghouse on the blast furnace charge hoods, a new RTO to be placed on the reverberatory furnace feed dryer stack, replacement of the reverberatory feed mechanism, enclosure of the blast furnace charge area, installation of charge level and temperature sensors in the blast furnace, changes to hoods and ducting, and a installation of a secondary HEPA filtration system downstream of the hard lead ventilation system baghouse and the MAC feed room baghouse.

Any air pollution control equipment and supporting equipment would be placed within the boundary of the existing established Exide large lead-acid battery recycling facility. The existing large lead-acid battery recycling facility is located in an area zoned as industrial, which has already been greatly disturbed. Most of the air pollution control equipment would be placed, either on existing foundations or over the area which was disturbed previously to build the facility. Construction related to the proposed project would require the removal of flooring for new foundations for the new scrubber and RTOs. These areas have been previously disturbed since there is an existing floor that needs to be removed and replaced with a new foundation capable of supporting the new scrubber, RTOs and related support structures. Therefore, since construction is not expected in areas that have not been disturbed, the proposed project is not expected to require physical changes to the environment that could disturb paleontological or archaeological resources. Therefore, the proposed project has no potential to cause a substantial adverse change to a historical or archaeological resource, directly or indirectly destroy a unique paleontological resource or site or unique geologic feature, or disturb any human remains, including those interred outside formal cemeteries. Finally, because the proposed project would involve construction activities in previously disturbed areas on-site at industrial facilities, it is unlikely that the county coroner or that the Native American Heritage Commission would need to be contacted. The proposed project is, therefore, not anticipated to result in any activities or promote any programs that could have a significant adverse impact on cultural resources in the district.

Based on the above discussion, the proposed project is not expected to create any significant adverse effect to a historical resource as defined in §15064.5; cause a new significant impact to an archaeological resource as defined in §15064.5; directly or indirectly destroy a unique paleontological resource, site, or feature; or disturb any human including those interred outside formal cemeteries.

Based upon these considerations, significant adverse cultural resources impacts are not anticipated.

	Potentially Significant Impact	Less Than Significant With Mitigation	Less Than Significant Impact	No Impact
VI. ENERGY. Would the project:				
a) Conflict with adopted energy conservation plans?	<input type="checkbox"/>	<input type="checkbox"/>	<input type="checkbox"/>	<input checked="" type="checkbox"/>
b) Result in the need for new or substantially altered power or natural gas utility systems?	<input type="checkbox"/>	<input type="checkbox"/>	<input checked="" type="checkbox"/>	<input type="checkbox"/>
c) Create any significant effects on local or regional energy supplies and on requirements for additional energy?	<input type="checkbox"/>	<input type="checkbox"/>	<input checked="" type="checkbox"/>	<input type="checkbox"/>
d) Create any significant effects on peak and base period demands for electricity and other forms of energy?	<input type="checkbox"/>	<input type="checkbox"/>	<input checked="" type="checkbox"/>	<input type="checkbox"/>
e) Comply with existing energy standards?	<input type="checkbox"/>	<input type="checkbox"/>	<input type="checkbox"/>	<input checked="" type="checkbox"/>

Significance Criteria

Impacts to energy and mineral resources will be considered significant if any of the following criteria are met:

- The project conflicts with adopted energy conservation plans or standards.
- The project results in substantial depletion of existing energy resource supplies.
- An increase in demand for utilities impacts the current capacities of the electric and natural gas utilities.
- The project uses non-renewable resources in a wasteful and/or inefficient manner.

Discussion

VI. a) & e) The proposed project is not expected to require any action which would result in any conflict with an adopted energy conservation plan or violation of any energy conservation standard. The proposed project is not expected to conflict with adopted energy conservation plans because Exide would be expected to continue implementing any existing energy conservation plans.

The proposed project is not expected to cause new development. The local jurisdiction or energy utility sets standards (including energy conservation) and zoning guidelines regarding new development and will approve or deny applications for building new equipment at the affected facility.

The proposed project is designed specifically to control air pollution emissions (criteria and TACs). As a result, the proposed project would not conflict with energy conservation plans, use

non-renewable resources in a wasteful manner, or result in the need for new or substantially altered power or natural gas systems.

VI. b), c) & d. In the 2014 Final EA for Rule 1420.1, the new replacement scrubber would be expected to be placed where the existing scrubber is removed. Under the proposed project, the existing Neptune scrubber would remain and the new scrubber would be installed. The 2014 Final EA for Rule 1420.1 also analyzed installing a wet ESP near the property boundary, which is no longer apart of the proposed project.

The 2014 amendments to Rule 1420.1 were expected to increase electric use associated with modified air handling systems and new air pollution control equipment. Natural gas fuel was expected to be consumed by the new RTO. Diesel fuel was expected to be consumed by construction equipment. Gasoline fuel was expected to be consumed by construction workers and source testers during operation.

The proposed project would require a new scrubber on the blast furnace air pollution control system, a new RTO and repurposed baghouse on the blast furnace charge hoods, a new RTO to be placed on the reverberatory furnace feed dryer stack, replacement of the reverberatory feed mechanism, enclosure of the blast furnace charge area, installation of charge level and temperature sensors in the blast furnace, changes to hoods and ducting, and a installation of a secondary HEPA filtration system downstream of the hard lead ventilation system baghouse and the MAC feed room baghouse.

The proposed project would also increase electric use associated with modified air handling systems and new air pollution control equipment. Natural gas fuel would be expected to be consumed by the new RTOs. Diesel fuel would be expected to be consumed by construction equipment. Gasoline fuel would be expected to be consumed by construction workers and source testers during operation. The following sections evaluate the various forms of energy sources affected by the proposed project.

Electricity Impacts

Analysis from the 2014 Final EA for Rule 1420.1

In the 2014 Final EA for Rule 1420.1, SCAQMD staff estimated electricity use for a proposed new wet ESP at Exide based on an existing wet ESP at Quemetco permit. The current process and process fugitive air handling system at Exide generates approximately 220,000 standard cubic feet per minute of air flow. This is twice the amount of air flow that the existing wet ESP Quemetco was designed to handle. Therefore, it was assumed that the new wet ESP system would need to be twice the size of the existing wet ESP at Quemetco. Based on these assumptions, 1,400 kilowatts would be needed to run the new wet ESP system. The wet ESP system would consume 1,400 kilowatt-hours of electricity in one hour and 12.8 gigawatt-hours per year (1,400 x 24 hours x 365 x gigawatt-hr/1,000,000 kilowatt-hr).

Proposed Project

Exide has selected to install another scrubber instead of replacing the existing Neptune scrubber with a wet ESP or new scrubber. The proposed project would require a new scrubber on the blast furnace air pollution control system, a new RTO and repurposed baghouse on the blast furnace charge hoods, a new RTO to be placed on the reverberatory furnace feed dryer stack, replacement of the reverberatory feed mechanism, enclosure of the blast furnace charge area,

installation of charge level and temperature sensors in the blast furnace, changes to hoods and ducting, and installation of a secondary HEPA filtration system downstream of the hard lead ventilation system baghouse and the MAC feed room baghouse. Additional electricity would be required by the RTOs, repurposed baghouse and associated blowers. The ratings of existing equipment and new or replacement equipment are presented in Table 2-22. Based on these changes approximately 0.65 megawatt-hour/hour or (870 brake horsepower-hour x kilowatt/1,341 horsepower) 5,683 megawatt-hours per year (0.65 megawatt-hour/hour x 24 hour/day x 365 day/year) would be required by the proposed project.

**Table 2-22
Power Ratings of New and Replaced Equipment**

Description	Existing, bhp	Proposed Project Rating, bhp	Rating Increase, bhp
Cupola Thimble RTO Combustion		10	10
Cupola Thimble RTO Booster Blower		200	200
Reverb Baghouse Blower	450	450	0
Cupola Baghouse Blower	250	450	200
Cupola Baghouse No. 2		450	450
Rotary Dryer Baghouse	100	100	0
Rotary Dryer RTO Combustion		10	10
Rotary Dryer RTO Blower (No Blower)		0	0
Totals	800	1,670	870

The Los Angeles Department of Water and Power (LADWP) supplies electricity to the Exide facility. The California Energy Commission (CEC) staff reports that LADWP consumed 25,921 total gigawatt-hours in 2008 with a peak hourly consumption of 5,717 megawatt-hours in 2008. The additional 5,683 megawatt-hours annually required to run the new air pollution control system at the affected facility would be 0.02 percent of the 2008 consumption of 25,921 gigawatts and the peak consumption of 0.65 megawatt-hours would be 0.01 percent of the peak 5,717 megawatt-hours consumption. Therefore, SCAQMD staff concludes that the amount of electricity required to meet the incremental energy demand associated with proposed project would be sufficient and would not result in a significant adverse electricity energy impact from Exide.

Natural Gas Impacts

Analysis from the 2014 Final EA for Rule 1420.1

Natural gas use (0.14 million therms per year) for the new RTO on the reverberatory furnace feed dryer stack was estimated based on the estimated rating of 1.58 million BTU per hour. The most recent annual non-residential natural gas consumption for Los Angeles County on the CEC website is for the 2011 calendar year. The use of 0.14 million therms of natural gas per year by the new RTO unit was less than a percent (0.0079%) of the total 1,752 million therms of natural gas consumed by Los Angeles County; therefore, SCAQMD staff concluded that the amount of natural gas required to meet the incremental energy demand associated with the 2014 amendments to Rule 1420.1 would be sufficient and would not result in a significant adverse natural gas energy impact.

Proposed Project

The proposed project only addresses the Exide facility. Based on the permit application the new RTOs would be rated at 2.5 and 4.6 million British thermal units (Btu) per hour (71 therms per hour). Assuming continual use, approximately 0.62 million therms ((71 therm/hr x 24 hr/day x 7 day/week x 52 weeks/year)/1,000,000) would be consumed per year by the proposed project.

Approximately 1,752 million therms were consumed in the Los Angeles County in 2011. The use of 0.62 million therms of natural gas per year by proposed project is less than one percent (0.035 percent) of the total 1,752 million therms of the non-residential natural gas consumed by Los Angeles County. So, although the proposed project would result in an additional 0.5 million therms per year (0.64 therms - 0.14 therms), the total amount of natural gas used would still be less than one percent of the non-residential natural gas consumed by Los Angeles County. Therefore, SCAQMD staff concludes that the amount of natural gas required to meet the incremental energy demand associated with the proposed project would be sufficient and would not result in significant adverse natural gas energy impact (see Table 2-22).

**Table 2-22
Total Projected Natural Gas Demand from the Proposed Project**

Description	Daily Usage
Natural Gas Consumption Proposed Project, mmtherm/year	0.62
2011 Non-Residential Natural Gas Consumption in Los Angeles County, mmtherm/year	1,752
Percentage of Fuel Supply	0.035
Significant?	No

California Energy Commission, 2013, <http://www.ecdms.energy.ca.gov/gasbycounty.aspx>

Diesel Impacts

Construction Diesel Use

2014 Final EA for Rule 1420.1

Approximately 152 gallons of diesel fuel on a peak day would be expected to be consumed by construction equipment and delivery trucks at the Exide facility during construction. According to the 2012 AQMP, 235 million gallons of diesel is consumed per day in Los Angeles County. Since 152 gallons of diesel per day is far less than one percent (0.00007 percent) of the diesel available, the 2014 amendments to Rule 1420.1 were not considered to have a significant adverse diesel fuel use impact from construction.

Proposed Project

Approximately 116 gallons of diesel fuel on a peak day would be expected to be consumed by construction equipment and delivery trucks (see Appendix A). This is less than the 152 gallons of diesel fuel projected for construction in the 2014 Final EA for Rule 1420.1. According to the 2012 AQMP, 235 million gallons of diesel is consumed per day in Los Angeles County. Since 116 gallons of diesel per day is far less than one percent (0.00005 percent) of the diesel available, the proposed project is not considered to have a significant adverse diesel fuel use impact from construction.

Operational Diesel Use

2014 Final EA for Rule 1420.1

One additional truck trip per year to dispose of additional spent metal would be expected to use four gallons of diesel at Exide. According to the 2012 AQMP, 235 million gallons of diesel is consumed per day. Since four gallons of diesel per day is far less than one percent (0.000002 percent) of the diesel available, the 2014 amendments to Rule 1420.1 were not considered to have a significant adverse diesel fuel use impact from construction.

Proposed Project

Operational trips would be related to additional disposal of spent metal from the new scrubber, additional disposal and replacement of additional filter media (Baghouse #2 and new dust collectors) and replacement of thermal media from the new RTOs. Five haul truck trips would be required to disposal of additional filter media and five delivery truck trips to deliver new filter media potentially annually. would be required annually for additional spent metal disposal. Two additional truck trips every four to five years would be needed to replace thermal media in the new RTOs. The disposal and replacement schedules are not directly correlated because of the different capacities of the streams and new equipment, so it is unlikely the spent metal, replacement filter media or replacement thermal media trips would overlap. Assuming the HEPA filters and the baghouse filters are replaced at the same time, the worst-case operational diesel fuel use would be consumed during the five haul truck trips and five deliver truck trips related to filter disposal and replacement. The spent filters would be sent to either the Republic Services La Paz County Landfill in Parker, Arizona (226 miles from the Exide facility) or the US Ecology, Inc. facility in Beatty, Nevada (305 miles from the Exide Facility). Fuel use was based on the US Ecology, Inc., facility in Beatty, Nevada to be conservative. Filter delivery trucks were assumed to travel 40 miles one-way (80 miles round trip). Based on these assumptions 86 gallons of diesel fuel would be consumed on a peak day.

According to the 2012 AQMP, 235 million gallons of diesel is consumed per day. Since 86 gallons of diesel per day is far less than one percent (0.00004 percent) of the diesel available, the proposed project is not considered to have a significant adverse diesel fuel use impact from construction. Therefore, the proposed project is not expected to be significant for diesel fuel use in during operations.

Gasoline Usage

Construction Gasoline Use

2014 Final EA for Rule 1420.1

Ten construction worker trips were expected on a peak day on a given day. Based on a 20 mile round trip, and a 10 mile per gallon fuel efficiency, approximately 40 gallons of gasoline were expected to be used on a peak day. The 2012 AQMP states that 235 million gallons of gasoline are consumed per day in Los Angeles County. An additional 40 gallons of gasoline consumed on a peak day (0.00002 percent of the daily consumption) was not expected to have a significant adverse impact on gasoline supplies.

Proposed Project

Sixty construction worker trips are expected on a peak day (during the structure construction phase) on a given day. Based on a 20 mile round trip, and a 10 mile per gallon fuel efficiency, approximately 240 gallons of gasoline would be used on a peak day. The 2012 AQMP states that 3,658 million gallons of gasoline are consumed per day in Los Angeles County. While the gasoline use in the proposed project is greater (240 - 235 = 5 gallons) than the amount estimated in the 2014 Final EA for Rule 1420.1, the additional 240 gallons of gasoline consumed on a peak day (0.000007 percent of the daily Los Angeles County consumption) is not expected to have a significant adverse impact on gasoline supplies.

Operational Gasoline Use

2014 Final EA for Rule 1420.1

Additional source testing was expected to require an additional gasoline-fueled vehicle trip to the Exide facility on the day of sources testing. Based on a 20 mile round trip, and a 10 mile per gallon fuel efficiency, approximately four gallons of gasoline were expected to be used on the source test day. The 2012 AQMP states that 235 million gallons of gasoline are consumed per day in Los Angeles County. An additional four gallons of gasoline consumed on a peak day (0.000002 percent of the daily consumption) was not expected to have a significant adverse impact on gasoline supplies.

Proposed Project

Additional worker trips may be associated with additional source testing, replacement of filter media and replacement of RTO thermal media. The proposed project is not expected to change the number of source testing days. Additional source testing would require an additional gasoline-fueled vehicle trip to the facility on the day of sources testing. It was assumed that six workers would be required to replace filter media (six additional gasoline-fueled vehicle trips). The replacement of the RTO thermal media was assumed to take six workers).

Based on a 20 mile round trip, and a 10 mile per gallon fuel efficiency, approximately four gallons of gasoline would be used by a worker vehicle trip. The 2012 AQMP states that 3,658 million gallons of gasoline are consumed per day in Los Angeles County. An additional 24 gallons of gasoline (six worker trips) consumed on a peak day (0.0000007 percent of the daily consumption) is not expected to have a significant adverse impact on gasoline supplies during operation.

Based upon these considerations, significant adverse energy impacts are not anticipated.

	Potentially Significant Impact	Less Than Significant With Mitigation	Less Than Significant Impact	No Impact
VII. GEOLOGY AND SOILS. Would the project:				
a) Expose people or structures to potential substantial adverse effects, including the risk of loss, injury, or death involving:	<input type="checkbox"/>	<input type="checkbox"/>	<input type="checkbox"/>	<input checked="" type="checkbox"/>
• Rupture of a known earthquake fault, as delineated on the most recent Alquist-Priolo Earthquake Fault Zoning Map issued by the State Geologist for the area or based on other substantial evidence of a known fault?	<input type="checkbox"/>	<input type="checkbox"/>	<input type="checkbox"/>	<input checked="" type="checkbox"/>
• Strong seismic ground shaking?	<input type="checkbox"/>	<input type="checkbox"/>	<input type="checkbox"/>	<input checked="" type="checkbox"/>
• Seismic-related ground failure, including liquefaction?	<input type="checkbox"/>	<input type="checkbox"/>	<input type="checkbox"/>	<input checked="" type="checkbox"/>
b) Result in substantial soil erosion or the loss of topsoil?	<input type="checkbox"/>	<input type="checkbox"/>	<input type="checkbox"/>	<input checked="" type="checkbox"/>
c) Be located on a geologic unit or soil that is unstable or that would become unstable as a result of the project, and potentially result in on- or off-site landslide, lateral spreading, subsidence, liquefaction or collapse?	<input type="checkbox"/>	<input type="checkbox"/>	<input type="checkbox"/>	<input checked="" type="checkbox"/>
d) Be located on expansive soil, as defined in Table 18-1-B of the Uniform Building Code (1994), creating substantial risks to life or property?	<input type="checkbox"/>	<input type="checkbox"/>	<input type="checkbox"/>	<input checked="" type="checkbox"/>
e) Have soils incapable of adequately supporting the use of septic tanks or alternative wastewater disposal systems where sewers are not available for the disposal of wastewater?	<input type="checkbox"/>	<input type="checkbox"/>	<input type="checkbox"/>	<input checked="" type="checkbox"/>

Significance Criteria

Impacts on the geological environment will be considered significant if any of the following criteria apply:

- Topographic alterations would result in significant changes, disruptions, displacement, excavation, compaction or over covering of large amounts of soil.
- Unique geological resources (paleontological resources or unique outcrops) are present that could be disturbed by the construction of the proposed project.

- Exposure of people or structures to major geologic hazards such as earthquake surface rupture, ground shaking, liquefaction or landslides.
- Secondary seismic effects could occur which could damage facility structures, e.g., liquefaction.
- Other geological hazards exist which could adversely affect the facility, e.g., landslides, mudslides.

Discussion

VII. a) In the 2014 Final EA for Rule 1420.1, the new replacement scrubber would be expected to be placed where the existing scrubber is removed. Under the proposed project, the existing Neptune scrubber would remain and the new scrubber would be installed. The 2014 Final EA for Rule 1420.1 also analyzed installing a wet ESP on-site near the property boundary, which is no longer apart of the proposed project.

The proposed project would require a new scrubber on the blast furnace air pollution control system, a new RTO and repurposed baghouse on the blast furnace charge hoods, a new RTO to be placed on the reverberatory furnace feed dryer stack, replacement of the reverberatory feed mechanism, enclosure of the blast furnace charge area, installation of charge level and temperature sensors in the blast furnace, changes to hoods and ducting, and a installation of a secondary HEPA filtration system downstream of the hard lead ventilation system baghouse and the MAC feed room baghouse.

Analysis in the 2014 Final EA for Rule 1420.1

It was assumed in the analysis for 2014 amendments to Rule 1420.1 that most of the construction would occur without changes to the existing foundation, and therefore, was not expected to result in any geology and soil impacts. Construction related to 2014 amendments to Rule 1420.1 were expected to require earthmoving to prepare foundations if the wet ESP option was chosen by Exide.

The 2014 Final EA for Rule 1420.1 noted that Exide has a small portion of the facility that is located in an area where there has been historic occurrence of liquefaction, or local geological, geotechnical and groundwater conditions indicated a potential for permanent groundwater displacements in the event of an earthquake.⁴ The liquefaction zone bisects the property from the most western end of the property by the Union Pacific and Santa Fe Road to the north down to the southwest corner of the storm water retention pond, which may need to be replaced with storm water storage tanks to provide space for air pollution equipment. The Uniform Building Code requirements also consider liquefaction potential and establish stringent requirements for building foundations in areas potentially subject to liquefaction. The analysis stated that the 2014 amendments to Rule 1420.1 did not require a specific means of control technology or specify placement of the control technology; however, due to spatial needs of the wet ESP, it was anticipated that the pond area would be most reasonable.

Proposed Project

Exide has decided to install an additional scrubber instead of replacing the existing Neptune scrubber with a wet ESP or larger scrubber. Any air pollution control equipment and supporting equipment would be placed within the boundary of the existing established Exide large lead-acid battery recycling facility. The existing large lead-acid battery recycling facility is located in an

⁴ The Exide Corporation Hazard Waste Facility Permit Draft Environmental Impact Report, SCH No. 93051013 June 2006

area zoned as industrial, which has already been greatly disturbed. Most of the air pollution control equipment would be placed, either on existing previously paved foundations or over the area which was disturbed previously to build the facility. Construction related to the proposed project would require the removal of flooring for new foundations for the new scrubber and RTOs. These areas have been previously disturbed since there is an existing floor that needs to be removed and replaced with a new foundation capable of supporting the new scrubber, RTOs and related support structures. Therefore, since construction is not expected in areas that have not been disturbed, the proposed project is not expected to require physical changes to the environment that could that would affect geology and soils.

Because Southern California is an area of known seismic activity, existing facilities are expected to conform to the Uniform Building Code and all other applicable state and local building codes. As part of the issuance of building permits, local jurisdictions are responsible for assuring that the Uniform Building Code is adhered to and can conduct inspections to ensure compliance. The Uniform Building Code is considered to be a standard safeguard against major structural failures and loss of life. The basic formulas used for the Uniform Building Code seismic design require determination of the seismic zone and site coefficient, which represents the foundation condition at the site.

Since a wet ESP is no longer part of the proposed project, no equipment is expected to be placed in the suspected liquefaction zone. However, the owners/operators of the affected facility that may need air pollution control equipment to comply with Rule 1420.1 would need to follow the Uniform Building Code requirements about building structures in areas potentially subject to liquefaction, if any air pollution control equipment or replacement equipment such as storage tanks is placed over the areas identified as subject to liquefaction. The liquefaction conditions however are an existing condition and there has not been a historical problem at the existing facility. In addition, changes due to the proposed project would not directly cause or worsen the existing liquefaction possibility.

Since all structures and control technology would be built according to the Uniform Building Code, the proposed project would not expose people or structures to risks of loss, injury, or death involving: rupture of an earthquake fault, seismic ground shaking, ground failure or landslides. Since the affected facility already exists, the proposed project is not expected to increase exposure to existing earthquake risk.

VII. b) Construction related to the proposed project may require earth work to prepare foundations for the new scrubber and RTOs. The new scrubber would be placed within the same building that currently houses the existing scrubber, so earth work would occur within an existing building. The RTOs would also be placed within existing buildings. In addition, Rule 1420.1 requires the encapsulation of all facility grounds to prevent lead contamination (i.e., paving or asphaltting of all surfaces). All disturbed surfaces are expected to be re-compacted and re-paved after construction is finished. All construction is expected to follow the Uniform Building Code. Therefore, no significant soil erosion or significant losses of topsoil, significant unstable earth conditions or significant changes in geologic substructures are expected to occur at the affected facility as a result of implementing the proposed project.

VII. c) Since the soil at Exide where any earthwork is expected is within an existing building and has already been disturbed, it is expected that the soil types present at the affected facility would not be further susceptible to expansion or liquefaction other than is already existing.

Furthermore, subsidence and liquefaction is not anticipated to be a problem since any excavation, grading, or filling activities are expected to follow the Uniform Building Code. Additionally, the affected areas are not envisioned to be prone to landslides, instability, or have unique geologic features since the affected existing facility is located in industrial areas in a flat area.

VII. d) & e) Since the proposed project would affect soils at an existing established facility within an existing building located in a highly developed industrial zone, it is expected that people or property would not be exposed to expansive soils or soils incapable of supporting water disposal. The Exide facility has an existing wastewater treatment system that would continue to be used, and these systems are expected to have the capacity to support this proposed project. Sewer systems are available to handle wastewater produced and treated by the affected facility. Therefore, the proposed project would not require the installation of new septic tanks or alternative wastewater disposal systems at the affected facility. As a result, the proposed project would not require operators to utilize septic systems or alternative wastewater disposal systems. Thus, the proposed project would not adversely affect soils normally associated with a septic system or alternative wastewater disposal system.

Based upon these considerations, significant adverse geology and soil impacts are not anticipated.

	Potentially Significant Impact	Less Than Significant With Mitigation	Less Than Significant Impact	No Impact
VIII. HAZARDS AND HAZARDOUS MATERIALS. Would the project:				
a) Create a significant hazard to the public or the environment through the routine transport, use, and disposal of hazardous materials?	<input type="checkbox"/>	<input type="checkbox"/>	<input checked="" type="checkbox"/>	<input type="checkbox"/>
b) Create a significant hazard to the public or the environment through reasonably foreseeable upset conditions involving the release of hazardous materials into the environment?	<input type="checkbox"/>	<input type="checkbox"/>	<input checked="" type="checkbox"/>	<input type="checkbox"/>
c) Emit hazardous emissions, or handle hazardous or acutely hazardous materials, substances, or waste within one-quarter mile of an existing or proposed school?	<input type="checkbox"/>	<input type="checkbox"/>	<input checked="" type="checkbox"/>	<input type="checkbox"/>

	Potentially Significant Impact	Less Than Significant With Mitigation	Less Than Significant Impact	No Impact
d) Be located on a site which is included on a list of hazardous materials sites compiled pursuant to Government Code §65962.5 and, as a result, would create a significant hazard to the public or the environment?	<input type="checkbox"/>	<input checked="" type="checkbox"/>	<input type="checkbox"/>	<input type="checkbox"/>
e) For a project located within an airport land use plan or, where such a plan has not been adopted, within two miles of a public use airport or a private airstrip, would the project result in a safety hazard for people residing or working in the project area?	<input type="checkbox"/>	<input type="checkbox"/>	<input checked="" type="checkbox"/>	<input type="checkbox"/>
f) Impair implementation of or physically interfere with an adopted emergency response plan or emergency evacuation plan?	<input type="checkbox"/>	<input type="checkbox"/>	<input checked="" type="checkbox"/>	<input type="checkbox"/>
g) Expose people or structures to a significant risk of loss, injury or death involving wildland fires, including where wildlands are adjacent to urbanized areas or where residences are intermixed with wildlands?	<input type="checkbox"/>	<input type="checkbox"/>	<input type="checkbox"/>	<input checked="" type="checkbox"/>
h) Significantly increased fire hazard in areas with flammable materials?	<input type="checkbox"/>	<input type="checkbox"/>	<input checked="" type="checkbox"/>	<input type="checkbox"/>

Significance Criteria

Impacts associated with hazards will be considered significant if any of the following occur:

- Non-compliance with any applicable design code or regulation.
- Non-conformance to National Fire Protection Association standards.
- Non-conformance to regulations or generally accepted industry practices related to operating policy and procedures concerning the design, construction, security, leak detection, spill containment or fire protection.
- Exposure to hazardous chemicals in concentrations equal to or greater than the Emergency Response Planning Guideline (ERPG) 2 levels.

Discussion

VIII. a) & b) Like the project analyzed in the 2014 Final EA for Rule 1420.1, the proposed project may increase the amount of arsenic and lead disposed of by capturing additional arsenic and lead emissions through control technology, but the increased amount of arsenic and lead captured would be the arsenic and lead that without Rule 1420.1 would be emitted into the air.

Thus, the capture of these arsenic and lead emissions would reduce arsenic and lead exposure to the public and environment.

The 2014 Final EA for Rule 1420.1 included the transport of contaminated soil and concrete from the demolition of the stormwater retention pond, which will now not be demolished under the proposed project. However, the proposed project includes the removal of existing foundation and excavation of soil in order to install a new foundation able to support the new scrubber and RTOs, which was not included in the 2014 Final EA for Rule 1420.1. The amount of hazardous soil and concrete waste evaluated in the Final EA for Rule 1420.1 (8,150 cubic yards of material) is much more than the amount of hazardous soil and concrete expected to be hauled away by the proposed project (320 cubic yards). Therefore, the proposed project would reduce the possibility of a significant hazard from transportation of contaminated concrete and soil when compared to the project evaluate in the 2014 Final EA for Rule 1420.1, which was not expected to be significant for any environmental topic.

Arsenic and lead bearing slag are already transported for treatment offsite and out of the Basin. The additional arsenic and lead captured by new air pollution control systems would be returned to the recycling process, which is the same process as the arsenic and lead captured by the existing scrubber system. However, some of the arsenic and lead resulting from new control technology would end up in the final slag which is eventually sent offsite. The additional arsenic and lead bearing slag may require only one additional truck trip annually (see Section XVI. Solid/Hazardous Waste), so no new significant hazards are expected to the public or environment through its routine transport, use and disposal. The addition of one new truck trip per year carrying arsenic and lead bearing slag is not expected to result in a significant hazard to the public or the environment through the routine transport or risk of upset (e.g., accident), because the slag would be transported in solid form in vehicles that are clearly marked along roads that are paved. This project would not change the potential consequence of a risk of upset or the methods for recovery.

The following discussion on the control of contamination during transportation was taken from the Draft Negative Declaration for the DTSC's Interim Measures – North and Southern Assessment Areas certified September 16, 2014 (http://www.dtsc.ca.gov/HazardousWaste/Projects/upload/2014-09-16_Exide_IMWP-CEQA-IS-1-Final.pdf). This discussion should also apply to any construction or operational hazardous waste (excavated concrete, slag, baghouse filters, HEPA filters, etc.) related to the proposed project. “The risk of upset associated with the proposed project is low because of the level of contamination and the fact that the contaminated soil material will be transported off-site by licensed, experienced haulers. Licensed haulers are trained to understand Department of Transportation regulations and safety protocols when hauling hazardous materials in accordance with Title 49 of the Code of Federal Regulations (CFR) Parts 171-179 and 40 CFR Section 263 Sub Part C. Title 49 Parts 171-179 addresses the hazardous materials regulations and associated protocol including hazardous materials communications, emergency response information, training requirements, security plans, requirements for shipments and packages, as well as regulations specific to various forms of transportation. Sub Part C identifies the immediate action and discharge clean up measures required in the event of a hazardous waste discharge. The driver has been instructed on spill control, containment and failure procedures, who to contact in case of emergency while transporting the materials (e.g. California Highway Patrol), and how the truck is to be labeled to ensure the consistent communication of information to first responders. The remediation activities include hazards that may be caused by human error or machinery

failure. Should an accidental spill occur on the highway, Department of Transportation regulations for spills will be observed. Potential receptors include anyone who comes in direct contact with the soil by way of direct skin contact, inhalation, or by ingestion. If a spill occurs, the driver of the truck will notify the local authorities for implementation of cleanup activities. Since the trucks will be appropriately labeled, any spill clean-up workers will be able to adequately wear the appropriate protective gear to handle this soil properly and safely.

In the event of an emergency or spill during transport to the treatment facility, the driver of the hauling truck will use the following procedures pursuant to established regulations:

- Park the vehicle in the most secure area available, away from homes, traffic, waterways, and businesses;
- Stay with the vehicle until appropriate support has arrived; move a safe distance away from the vehicle or spill material if danger exists; and
- Notify the appropriate emergency contacts.

Impacted soil spilled off-site will be properly removed and cleaned up pursuant to directions of local authorities (e.g., California Highway Patrol, city, county, etc.).”

The installation of temporary enclosures, negative pressure on buildings, requirement that all trash and debris be sorted in closed rolloff containers, decontamination of rolloff containers, and air monitoring with hand-held continuous particulate aerosol monitors as required by the July 2014 Construction and Activity Mitigation Plan would prevent health risk related to dust and particulates from work areas.

The additional arsenic and lead that may be controlled by a new air pollution control system would be captured in water cycled through the system. Arsenic and lead in water are not considered volatile. All wastewater systems would require secondary containment in the case of an upset to prevent the release of the arsenic and lead containing water. Therefore, like the replacement scrubber or new wet ESP system evaluated in the 2014 Final EA for Rule 1420.1, the new scrubber is not expected to create a significant hazard to the public or environment through reasonably foreseeable upset conditions involving the release of hazardous materials into the environment.

The RTOs would use natural gas combustion to reduce benzene and 1,3-butadiene. The emissions from natural gas combustion in the RTOs are analyzed in the Section III. Air Quality and Greenhouse Gas Emissions. No significant adverse air quality or GHG emission impacts were identified from the combustion of natural gas in the RTOs. The RTOs are expected to be commercial units. Commercial units are typically certified, listed or marked by safety organizations such as Underwriters Laboratories (UL), ETL Mark, and Conformité Européenne (CE). Equipment certified, listed or marked by safety organizations have met rigorous electrical and fire safety standards. Because the RTOs are commercial units and the nearest receptors are 100 meters away from the facility (100 meters from worker receptors and 1,400 meters from residential receptors), the RTOs are not expected to create a new significant hazard to the public or environment through reasonably foreseeable upset conditions involving the release of hazardous materials related to natural gas into the environment.

Therefore, the proposed project is not expected to create a new significant hazard to the public or environment through reasonably foreseeable upset conditions involving the release of hazardous materials into the environment.

VIII. c) No schools are located within a quarter mile of the affected facility. Therefore, the proposed project would not result in hazardous emissions, handling of hazardous or acutely hazardous materials, substances or wastes within one-quarter mile of an existing or proposed school.

VIII. d) The proposed project site is listed on the California Department of Toxic Control Hazardous Waste Facilities' List per Government Code §65962.5 (http://www.envirostor.dtsc.ca.gov/public/profile_report.asp?global_id=80001733; accessed on August 29, 2014). Exide has identified some areas where soils are contaminated with metals, primarily arsenic, lead, TCE, and PCE at the facility. Therefore, it is possible that the concrete and soil to be removed to lay the new foundations may also be contaminated. The areas expected to be disturbed by the proposed project are presented in Figure 2-2. The red squares in Figure 2-2 indicate the areas where the existing foundation would be removed and soil excavated. The entire facility is the subject of a RFI investigation that, as discussed in Chapter 1, will determine the extent of contamination and will be used to develop a plan to remediate the site. The new foundations for the new Scrubber and Kiln Dryer RTO are expected to be poured at the same location as the former foundations of RCRA Interim Status Unit Nos. 29 and 30, which were old wastewater system components that were removed without ensuring the removal of potentially contaminated soils. Unit No. 29 was a 33,087 gallon process tank that was used to collect sulfuric acid from the Acid Storage Tank (Unit No. 10) for pH adjustment, process water from the East Equalization Tank (Unit No. 22), and ferric chloride used to precipitate heavy metals. Unit No. 30 was a filtrate tank used to receive process water from the RMPS Filter Press (Unit No. 44) to initiate wastewater treatment.

It is expected the foundations required for the new equipment would need to be three feet thick slabs, which would require four feet deep excavations. According to a DTSC Memo on the Review of the Closure Care Cost Estimate for Permit Renewal and Bankruptcy Court Claim (hereinafter referred to as the DTSC Memo), dated June 17, 2014, the DTSC observed based on the inspection of Exide evaluating the Closure Plan, that if soils were contaminated, any closure of the facility would require the removal and disposal of at least five feet of contaminated soils. Under state law, a Closure Plan is required, among other things, to remove or decontaminate hazardous soils prior to partial or full closure of the property. (22 Cal. Code Regs. § 66264.112(b)(4)). Therefore, it was determined that if the Closure Plan soil removal requirements were followed for this project, any potentially contaminated soils that may be found in the excavated areas, would be mitigated to a level below significance. As such, a mitigation measure is being included that will require the removal of at least five feet of soil under each foundation required to be built. Furthermore, to assist in DTSC's efforts to prepare a complete survey of the property for the RFI and Consent Order, DTSC has requested that soil samples be taken of the excavated pit prior to the construction of the foundation. Therefore, soil sampling requirements are being added as a requirement of this project. This sampling would be done, per Consent Order requirements, to take advantage of the opportunity to further confirm existing site conditions. Results of the samples would be used to supplement ongoing RFI activities.

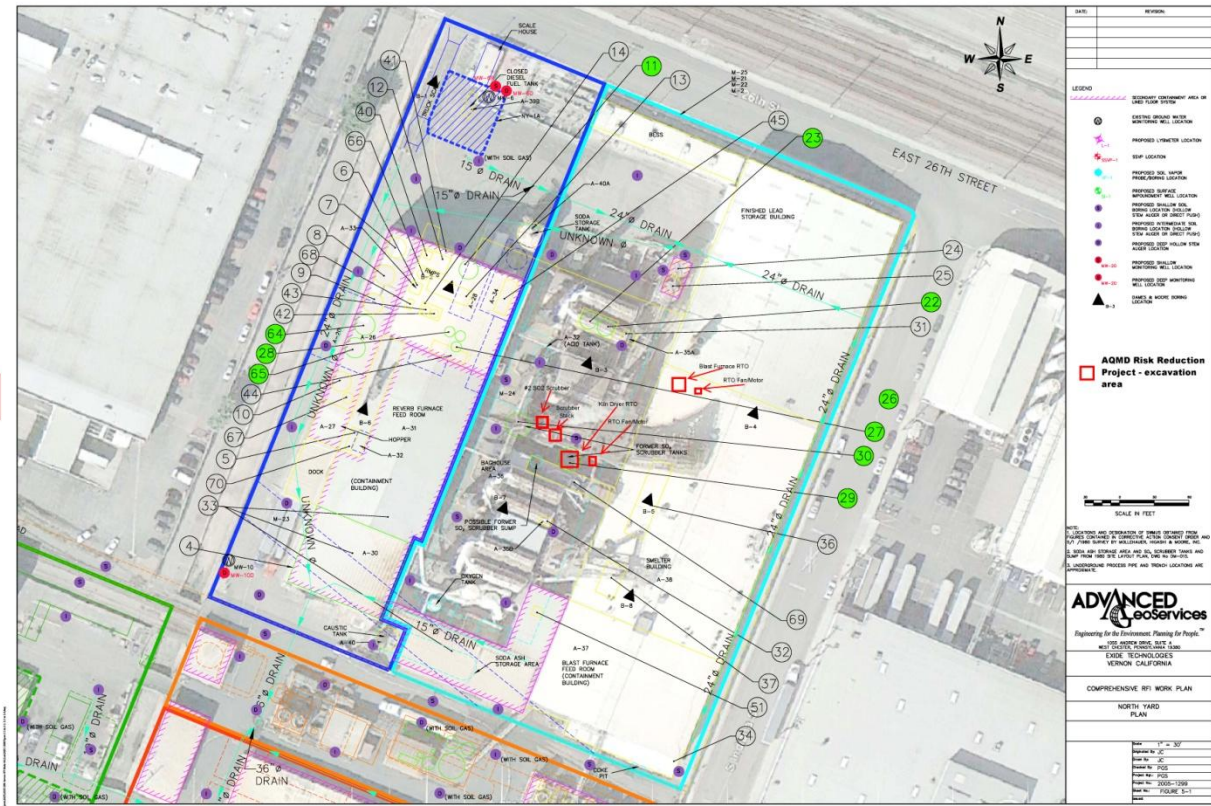

Figure 2-2
Areas Where Existing Foundations and Soil Would be Excavated

Based on DTSC’s [Corrective Action Consent Order](http://www.envirostor.dtsc.ca.gov/regulators/deliverable_documents/2384068131/Corrective%20Action%20Consent%20Order.pdf) (http://www.envirostor.dtsc.ca.gov/regulators/deliverable_documents/2384068131/Corrective%20Action%20Consent%20Order.pdf) and the DTSC Memo (http://www.dtsc.ca.gov/HazardousWaste/Projects/upload/2014-06-17_Exide-3rd-NOD-complete.pdf), the following mitigation measures have been created that will be sure to reduce potential hazardous materials impacts from any contaminated soil that may be encountered during excavation activities related to laying the foundations for control equipment, to a level below significance.

MMHAZ-01 – During the excavation phase of the proposed project, Exide shall:

- Notify DTSC at least 72 hours prior to each excavation.
- Identify, sample, characterize, handle, segregate, store, and dispose of excavated soils pursuant to local, state, and federal regulations and per the DTSC approved RFI Workplan (Section 9.0) and DTSC Consent Order.
- Remove at least five feet of soil under each slab foundation per DTSC’s Memorandum on the Review of the Closure and Post Closure Care Cost Estimate for Permit Renewal and Bankruptcy Court Claim as required by 22 CCR 66264.112(b)(4).
- Collect samples with the backhoe bucket after the bucket has scraped a clean surface on the area to be sampled. Excavation sidewall samples should be collected every 40 linear feet at an approximate 2.5 ft mid-point of the 5 foot excavation depth. With regard to the number of excavation bottom samples, the following DTSC guidance based on square footage should be used:

< 500 ft² – 2 samples
500 < 1,000 ft² - 3 samples
1,000 < 1,500 ft² - 4 samples
1,500 < 2,500 ft² - 5 samples
2,500 < 4,000 ft² - 6 samples
4,000 < 6,000 ft² - 7 samples
6,000 < 8,500 ft² - 8 samples
8,500 < 10,890 ft² - 9 samples

- Soil sample jars should be labeled properly and placed in zip-closure plastic bags in a chilled ice chest for transport to the analytical laboratory under chain-of-custody procedures pursuant to Section 9.0 of the DTSC approved RFI Workplan.
- Backfill per DTSC’s “Information Advisory - Clean Import Fill Material” guidance, and cap the excavation areas immediately following sampling and prior to receipt of laboratory data.
- Dispose all excavated soil and demolished concrete foundation at a landfill licensed to handle the waste based on the results of sample characterization.

The July 2014 Construction Activity Mitigation Plan also requires active monitoring and the abatement of work activities if concentrations exceed permissible levels until a third party consultant can determine the cause of the adverse reading and mitigation is applied that reduces the concentrations to permissible levels. The July 2014 Construction Activity Mitigation Plan included an enhanced afterburner. After consultation with SCAQMD staff in July 2014, Exide made a revision to the design. In this revised design, instead of enhancing the afterburner, the ventilation gases captured by the blast furnace charge hood would be treated separately from the blast furnace process gases. The ventilation gases from the charge enclosure at the top of the blast furnace would first pass through a cartridge filter to remove particulates before flowing through a new RTO. The new RTO would be in addition to and different from the other new RTO to be placed on the reverberatory furnace feed stack. The treated ventilation gases would then be combined with the collected gases from the slag tap and the refining kettle hoods before being sent to the new blast furnace baghouse #2 air pollution control train (with subsequent wet scrubbing) for further emission control. As a result, the Construction Activity Mitigation Plan was revised in August 2014. The proposed August 2014 amendments incorporate the charge hood’s new RTO construction control requirements.

The August 2014 revision of the Construction Activity Mitigation Plan has not yet been approved by the SCAQMD Hearing Board for inclusion into the Order for Abatement (Case No. 3151-32). SCAQMD staff has determined that the condition related to soil, handling, and storage procedures from demolition for the new RTO on the reverberatory furnace feed stack should be incorporated into this Draft MND to ensure enforceability. Hence, mitigation measure MMHAZ-02 has been crafted to reflect the August 2014 Construction Activity Mitigation Plan requirements for the blast furnace charge hood’s new RTO soil, concrete handling, and storage procedures.

MMHAZ-02- Prior to the installation of the Blast Furnace RTO and cartridge filter baghouse, Exide shall:

- Transfer excavated concrete and soil into a rolloff container that is staged inside of the total enclosure building, for proper off-site disposal or recycling.

Since mitigation measure MMHAZ-01 is expected to fully remove any contaminated soils that may be found by excavating down to five feet in the disturbed area pursuant to DTSC's Memo, the proposed project is expected to be less than significant to the public and environment for hazards and hazardous material.

With mitigation measures MMHAZ-01 and MMHAZ-02, adverse hazards and hazardous material impacts, related to excavating the concrete and soil for the blast furnace charge hood new RTO, are expected to be less than significant because mitigation measure MMHAZ-02 uses the same construction emissions control (from the July 2014 Construction Activity Mitigation Plan) of the rotary dryer's RTO.

Since the mitigation measures (MMHAZ-01 and MMHAZ-02) are included as part of this proposed project, a mitigation monitoring plan will be developed pursuant to CEQA Guidelines §15074(d).

Cumulative Impacts

As stated in Section III Air Quality Section of this Draft MND, SCAQMD project and cumulative significant thresholds are the same. So the proposed project would be significant for cumulative impacts from hazardous and hazardous material without mitigation measure MMHAZ1. However, since the proposed project would be less than significant with mitigation measure MMHAZ-01 on a project level, the proposed project would also be less than significant.

Based on the foregoing analysis, project-specific hazardous and hazardous material from implementing the proposed project could be potentially significant without mitigation measures MMHAZ-01 and MMHAZ-02; therefore, based on the above discussion, cumulative impacts would be potentially significant for hazardous and hazardous material without mitigation measures MMHAZ-01 and MMHAZ-02.

However, since the project-specific hazardous and hazardous material impacts from implementing the proposed project would not be significant for hazardous and hazardous material with mitigation measures MMHAZ-01 and MMHAZ-02; cumulative impacts are not expected to be significant for hazardous and hazardous material with mitigation measures MMHAZ-01 and MMHAZ-02. Therefore, potential adverse impacts from the proposed project would not be "cumulatively considerable" as defined by CEQA Guidelines §15064(h)(1) for adverse hazardous and hazardous material impacts. Per CEQA Guidelines §15064(h)(4), the mere existing of significant cumulative impacts caused by other projects alone shall not constitute substantial evidence that the proposed project's incremental effects are cumulative considerable.

VIII. e) Exide is not near any airports or private airstrips. The closest airport or airstrip is the Compton/Woodley Airport (901 W Alondra Blvd, Compton, CA), which is 8.7 miles from the affected facility. The proposed project would result in the reduction of arsenic, lead, benzene and 1,3-butadiene emissions. Secondary TAC emissions from the proposed project were addressed in the Air Quality section of this EA and found to be less than significant. Therefore,

no new hazards are expected to be introduced at the affected facility that could create safety hazards at local airports or private airstrips. Therefore, the proposed project is not expected to result in a safety hazard for people residing or working in the project area even within the vicinity of an airport.

VIII. f) Emergency response plans are typically prepared in coordination with the local city or county emergency plans to ensure the safety of the public (surrounding local communities), and the facility employees as well. The proposed project would not impair implementation of, or physically interfere with any adopted emergency response plan or emergency evacuation plan. The existing affected facility already has an emergency response plan in place. The addition of air pollution control equipment is not expected to require modification of the existing emergency response plan at the affected facility. Thus, the proposed project is not expected to impair implementation of or physically interfere with an adopted emergency response plan or emergency evacuation plan.

VIII. g) The proposed project is located in a highly developed area and is not adjacent to any wildland, so potential for a wildland fire from the proposed project does not exist.

VIII. h) The Uniform Fire Code and Uniform Building Code set standards intended to minimize risks from flammable or otherwise hazardous materials. Local jurisdictions are required to adopt the uniform codes or comparable regulations. Local fire agencies require permits for the use or storage of hazardous materials and permit modifications for proposed increases in their use. Permit conditions depend on the type and quantity of the hazardous materials at the facility. Permit conditions may include, but are not limited to, specifications for sprinkler systems, electrical systems, ventilation, and containment. The fire departments make annual business inspections to ensure compliance with permit conditions and other appropriate regulations. Further, businesses are required to report increases in the storage or use of flammable and otherwise hazardous materials to local fire departments. Local fire departments ensure that adequate permit conditions are in place to protect against potential risk of upset. The proposed project would not change the existing requirements and permit conditions.

The proposed project would require a new scrubber on the blast furnace air pollution control system, a new RTO and repurposed baghouse on the blast furnace charge hoods, a new RTO to be placed on the reverberatory furnace feed dryer stack, replacement of the reverberatory feed mechanism, enclosure of the blast furnace charge area, installation of charge level and temperature sensors in the blast furnace, changes to hoods and ducting, and installation of a secondary HEPA filtration system downstream of the hard lead ventilation system baghouse and the MAC feed room baghouse. The modifications would not involve increased fire risk because they would not involve flammable materials. The water in the new scrubber reduces the risk of fire from furnace emissions. However, the RTOs would combust natural gas. The RTOs are expected to be commercial units. Commercial units are typically certified, listed or marked by safety organizations such as Underwriters Laboratories (UL), ETL Mark, and Conformité Européenne (CE). Equipment certified, listed or marked by safety organizations have met rigorous electrical and fire safety standards. Because they are commercial units and the nearest receptors are 100 meters away from the facility (100 meter from worker receptors and 1,400 meters from residential receptors), the risk of fire hazards if any from the RTOs are expected to be not significant.

The proposed project would also not increase the existing risk of fire hazards in areas with flammable brush, grass, or trees. No substantial or native vegetation exists on or near the affected industrial facility (specifically because such areas could allow the accumulation of fugitive arsenic or lead dust). The existing rule requires the encapsulating (paving or asphaltting) of all facility grounds. So the proposed project is not expected to expose people or structures to wild fires. Therefore, no significant increase in fire hazards is expected at the affected facility associated with the proposed project.

Based upon these considerations, significant adverse hazards and hazardous materials impacts are not anticipated after mitigation.

	Potentially Significant Impact	Less Than Significant With Mitigation	Less Than Significant Impact	No Impact
IX. HYDROLOGY AND WATER QUALITY. Would the project:				
a) Violate any water quality standards, waste discharge requirements, exceed wastewater treatment requirements of the applicable Regional Water Quality Control Board, or otherwise substantially degrade water quality?	<input type="checkbox"/>	<input type="checkbox"/>	<input checked="" type="checkbox"/>	<input type="checkbox"/>
b) Substantially deplete groundwater supplies or interfere substantially with groundwater recharge such that there would be a net deficit in aquifer volume or a lowering of the local groundwater table level (e.g. the production rate of pre-existing nearby wells would drop to a level which would not support existing land uses or planned uses for which permits have been granted)?	<input type="checkbox"/>	<input type="checkbox"/>	<input checked="" type="checkbox"/>	<input type="checkbox"/>
c) Substantially alter the existing drainage pattern of the site or area, including through alteration of the course of a stream or river, or substantially increase the rate or amount of surface runoff in a manner that would result in substantial erosion	<input type="checkbox"/>	<input type="checkbox"/>	<input checked="" type="checkbox"/>	<input type="checkbox"/>

or siltation on- or off-site or flooding on- or off-site?

- d) Create or contribute runoff water which would exceed the capacity of existing or planned storm water drainage systems or provide substantial additional sources of polluted runoff?

	Potentially Significant Impact	Less Than Significant With Mitigation	Less Than Significant Impact	No Impact
e) Place housing or other structures within a 100-year flood hazard area as mapped on a federal Flood Hazard Boundary or Flood Insurance Rate Map or other flood hazard delineation map, which would impede or redirect flood flows?	<input type="checkbox"/>	<input type="checkbox"/>	<input type="checkbox"/>	<input checked="" type="checkbox"/>
g) Require or result in the construction of new water or wastewater treatment facilities or new storm water drainage facilities, or expansion of existing facilities, the construction of which could cause significant environmental effects?	<input type="checkbox"/>	<input type="checkbox"/>	<input checked="" type="checkbox"/>	<input type="checkbox"/>
h) Have sufficient water supplies available to serve the project from existing entitlements and resources, or are new or expanded entitlements needed?	<input type="checkbox"/>	<input type="checkbox"/>	<input checked="" type="checkbox"/>	<input type="checkbox"/>
i) Result in a determination by the wastewater treatment provider which serves or may serve the project that it has adequate capacity to serve the project's projected demand in addition to the provider's existing commitments?	<input type="checkbox"/>	<input type="checkbox"/>	<input checked="" type="checkbox"/>	<input type="checkbox"/>

Significance Criteria

Potential impacts on water resources will be considered significant if any of the following criteria apply:

Water Demand:

- The existing water supply does not have the capacity to meet the increased demands of the project, or the project would use more than 262,820 gallons per day of potable water.
- The project increases demand for total water by more than five million gallons per day.

Water Quality:

- The project will cause degradation or depletion of ground water resources substantially affecting current or future uses.
- The project will cause the degradation of surface water substantially affecting current or future uses.
- The project will result in a violation of National Pollutant Discharge Elimination System (NPDES) permit requirements.
- The capacities of existing or proposed wastewater treatment facilities and the sanitary sewer system are not sufficient to meet the needs of the project.

- The project results in substantial increases in the area of impervious surfaces, such that interference with groundwater recharge efforts occurs.
- The project results in alterations to the course or flow of floodwaters.

Discussion

Analysis from the 2104 Final EA for Rule 1420.1

In the 2014 Final EA for Rule 1420.1, the new replacement scrubber was expected to be placed where the existing scrubber would be removed. Under the proposed project, the existing Neptune scrubber would remain and the new scrubber would be installed. The 2014 Final EA for Rule 1420.1 also analyzed installing a wet ESP near the property boundary, which is no longer apart of the proposed project.

The RTO on the reverberatory furnace feed dryer stack is expected to be installed without changes to the existing foundation and would not use or generate any water; therefore, no hydrology or water quality impacts were expected from this unit. Water and wastewater impacts were expected from the wet ESP or replacement scrubber. Stormwater and wastewater impacts were also associated with replacement stormwater retention pond with stormwater storage tanks and modifications to stormwater system potentially required to provide room if the wet ESP were installed.

Proposed Project

Exide has selected to install an additional scrubber instead of replace the existing Neptune scrubber with a wet ESP or larger scrubber. The proposed project would require a new scrubber on the blast furnace air pollution control system, a new RTO and repurposed baghouse on the blast furnace charge hoods, a new RTO to be placed on the reverberatory furnace feed dryer stack, replacement of the reverberatory feed mechanism, enclosure of the blast furnace charge area, installation of charge level and temperature sensors in the blast furnace, changes to hoods and ducting, and a installation of a secondary HEPA filtration system downstream of the hard lead ventilation system baghouse and the MAC feed room baghouse.

Flooring would be removed to install foundations that would support the new scrubber and RTOs. These areas have previously been disturbed since there is an existing floor that needs to be removed and replaced with a new foundation capable of supporting the new scrubber, RTOs and support equipment. Water would be used to control dust associated with demolition of the floor and any associated earth work needed.

Adverse operational water and wastewater impacts would be associated with the new scrubber. All air pollution control equipment would be placed with existing buildings/enclosures so storm water and wastewater impacts related to placing control equipment outside (e.g., replacing the stormwater treatment pond with a wet ESP) analyzed in the 2014 Final EA for Rule 1420.1 would not occur under the proposed project.

IX. a)

Rule 1420.1 and compliance with Rule 1420.1 was not expected to alter any existing wastewater treatment requirements of the Los Angeles County Sanitation District and Regional Water Quality Control Board or otherwise substantially degrade water quality that the requirements are meant to protect.

Discharge concentrations are currently and would continue to be limited by the Industrial Wastewater Discharge Permit.⁵ The Hazardous Waste Facility Permit states that any wastewater that does not meet the discharge concentrations set by the Los Angeles County Sanitation District in the Industrial Wastewater Discharge Permit would be recycled through the treatment plant until the discharge criteria are met or discharged as hazardous waste.⁶ Since wastewater from the facility is treated in an on-site wastewater treatment facility, and is heavily regulated, no change in the water quality of the discharge is expected.

Construction related to the proposed project would require the removal of flooring for new foundations for the new scrubber and RTOs. These areas have been previously disturbed since there is an existing floor that needs to be removed and replaced with a new foundation capable of supporting the new scrubber and support equipment (approximately four foot foundations). Based on ground water monitoring reports (Appendix G of the Exide Corporation Hazardous Waste Facility Permit Draft Environmental Impact Report, June 2006, SCH No. 9351013, water level gauging data indicates that the ground water elevation on the Exide facility is greater than 71 feet below ground. Since the earthwork needed to prepare for replacement foundations for the new scrubber and new RTOs would only extend five feet below ground, construction impacts are not expected to adversely affect groundwater.

IX. b) Like the project analyzed by the 2014 Final EA for Rule 1420.1, the proposed project would not require the use of groundwater and all water would be treated in the wastewater treatment facility before directed into the sanitary sewer. Therefore, the proposed project would not substantially deplete groundwater supplies or interfere substantially with groundwater recharge.

IX. c) & d) Since all air pollution control equipment would be installed and operated within existing buildings/enclosures, the amount of storm water would not change and the existing system already directs the storm water to a single location at the facility (i.e., the retention pond), the proposed project is not expected to have significant adverse effects on any existing drainage patterns, or increase the rate or amount of surface runoff water that would exceed the capacity of existing or planned storm water drainage systems.

IX. e) & f) Like the project analyzed by the 2014 Final EA for Rule 1420.1, the proposed project does not include or require any new or additional construction activities to build additional housing that could be located in 100-year flood hazard areas. Similarly, sources affected by the proposed project are located within existing commercial or industrial facilities so no new building construction related to the proposed project would take place. Consequently, the proposed project is not expected to result in placing housing in 100-year flood hazard areas that could create new flood hazards. Therefore, the proposed project is not expected to generate significant impacts regarding placing housing in a 100-year flood zone.

For the same reasons as those identified in the preceding paragraph, the proposed project is not expected to create significant adverse risk impacts from flooding as a result of failure of a levee or dam or inundation by seiches, tsunamis, or mudflows because the proposed project does not

⁵ Personal communication with Los Angeles County Sanitation District on June 28, 2013.

⁶ Attachment "A" of the Exide Technologies, Hazardous Waste Facility Permit, 2006, dtsc.ca.gov/HazardousWaste/Projects/upload/Exide_dPermit.pdf.

require levee or dam construction, and the affected facility is located on flat land far from the ocean.

IX. g) Like the project analyzed by the 2014 Final EA for Rule 1420.1, the proposed project is not expected to generate significant water use or wastewater generation (see IX. h) below). Therefore, no additional water or waste water treatment facilities are expected within or beyond the Exide facility boundaries and an expansion of the facilities existing on-site wastewater treatment system is not necessary as the battery recycling activity is not expected to change from current operating levels.

Based on the analysis in this environmental checklist, the proposed project is not expected to result in the construction of new water or waste water treatment facilities or new storm water drainage facilities, or expansion of existing facilities, the construction of which could cause significant environmental effects.

IX. h)

Construction Impacts

Analysis from the 2014 Final EA for Rule 1420.1

At the Exide facility, the RTO on the reverberatory furnace feed dryer stack was expected to be installed without changes to the existing foundation, so no water was expected to be needed for dust suppression or construction. Exide was expected to replace the existing scrubber with a new scrubber to control arsenic emissions. However, the old scrubber was expected to be recycled and the new scrubber was expected to be installed in the same location on the existing foundation; therefore, no water for dust suppression or construction was expected from replacement of the scrubber.

Water was expected to be used for dust suppression during construction, if the storm water retention pond was removed to provide space for a wet ESP. The disturbed area was expected to be approximately one acre in size. One acre is 43,560 square feet. Assuming one gallon per square foot and watering three times daily, approximately 130,681 gallons of water per day would be used. The use of 130,681 gallons of water per day is less than the SCAQMD's significance threshold of 262,820 gallons per day of potable water and total water demand of more than five million gallons per day. Thus, sufficient water supplies are expected to be available to serve the project from existing entitlements and resources without the need for new or expanded entitlements. Therefore, the 2014 amendments to Rule 1420.1 were not expected to be significant for water demand during construction.

Proposed Project

Construction related to the proposed project would require the removal of flooring for new foundations for the new scrubber and RTOs. The areas have been previously disturbed since there is an existing floor that needs to be removed and replaced with a new foundation capable of supporting the new scrubber and support equipment. Therefore, water use would be associated with demolition of the floor, and any earth work needed. However, while the construction area for proposed project would be approximately the same size (one acre), as the area estimated to be disturbed in the 2014 Final EA for Rule 1420.1; the construction area would be located inside existing structures and paved, except for the areas where flooring is removed. In addition, the entire area of the stormwater retention pond would have been disturbed according to the 2014 Final EA for Rule 1420.1, but only specific areas related to demolished, replaced or new

equipment would be disturbed inside existing structures by the proposed project. Therefore, the amount of water during construction that would be used by the proposed project is expected to be less than that estimated and disclosed in the 2014 Final EA for Rule 1420.1, which was less than significant.

Operational Impacts

Analysis from the 2014 Final EA for Rule 1420.1

In the analysis in the 2014 Final EA for Rule 1420.1, Exide was expected to replace the existing scrubber with a replacement scrubber or install a new wet ESP. The size of the replacement scrubber was not known at this time. Exide's existing Neptune scrubber has an influent and effluent flow rate of 25 to 30 gallons per minute. As a worst-case, it was assumed that twice the flow rate was needed. Therefore, the replacement scrubber was expected to need 30 gallons of water per minute (43,200 gallons of water per day) more than the existing scrubber uses. Based on the air flow rate requirements, the new wet ESP system at Exide was estimated to be twice the size as the existing wet ESP at Quemetco, which is 14.6 gallons of water per minute. Therefore, the new wet ESP was expected to require approximately 29.2 gallons of water per minute (42,048 gallons per day). However, it was anticipated that Exide would choose either a wet scrubber or a wet ESP to comply with Rule 1420.1 and not both. Therefore, the worst case was expected to be 43,200 gallons of additional water from the replacement scrubber.

The combined additional use from both facilities of 53,856 gallons of water per day was less than the significance threshold of 262,820 gallons per day of potable water and total water demand of more than five million gallons per day. Therefore, sufficient water supplies are expected to be available to serve the project from existing entitlements and resources without the need for new or expanded entitlements. Therefore, the 2014 amendments to Rule 1420.1 were not expected to be significant for operational water demand.

Proposed Project

The permit application for the new scrubber estimates that 40 gallons per minute of water would be needed. Therefore, the maximum daily water usage from the new scrubber would be 57,600 gallons (40 gal/min x 60 min/hr x 24 hr/day) on a peak day. However, the water is recycled in the scrubber, so on a daily basis the water used would be less.

The combined water use estimated for Quemetco in the 2014 Final EA for Rule 1420.1 and the proposed project at Exide would generate 68,256 gallons of water per day (10,656 gallons of water per day at Quemetco + 57,600 gallons per day from the proposed project at Exide), which is 14,400 gallons of water per day more than the 53,856 gallons of water per day estimated by the 2014 Final EA for Rule 1420.1. However, 68,256 gallons of water per day is still less than the significance threshold of 262,820 gallons per day of potable water and total water demand of more than five million gallons per day.

Exide receives their water supply from the Central Basin Municipal Water District located in Commerce, CA. As noted in the Water District's August 2014 report (http://www.centralbasin.org/en/wp-content/uploads/sites/2/2014/08/County-Report-Final_August.pdf) to the County of Los Angeles Supervisors, "the Central Basin's service area increased its population growth by approximately 18 percent over the last 20 years. But over the same period, water demand has remained remarkably consistent." The report also provides the water demand that is met on an annual basis. For fiscal year 2013-2014, the water supply was

33,949 acre-feet, which equates to 11,062 million gallons per year (using the conversion of 325,853 gallons per acre-foot). The report states that California is entering its “third year of drought with reduced supplies of imported water and newly implemented restrictions on water use.” Metropolitan Water District member agencies developed the Integrated Resource Plan (IRP), which focuses on improved conservation efforts and pursue alternate water sources, such as recycled water for non-potable use, reducing imported water use to less than 50 percent of the total regional supply.

As discussed earlier, the proposed project would require 68,256 gallons per day or 25 million gallons per year. Thus, the impact from the proposed project is 0.2 percent of the current demand from the water supplier and the water demand can be determined to be less than significant.

Therefore, although the proposed project would use more water, sufficient water supplies are expected to be available to serve the proposed project from existing entitlements and resources without the need for new or expanded entitlements. Therefore, the existing project is not expected to be significant for operational water demand.

IX. i)

Analysis from the 2014 Final EA for Rule 1420.1

The maximum wastewater discharge rate of the wastewater system needed was estimated to be 30 gallons of wastewater per minute (43,200 gallons of wastewater per day) based on the wastewater discharge rates of replacement scrubber. The wastewater system at Exide treats both process water and storm water before it is discharged to the sanitary sewer system.

Proposed Project

The permit application for the new scrubber estimates that 40 gallons per minute would be needed. The discharge rate of a scrubber is typically the same as its fill rate; therefore, it was assumed that the discharge rate of the new scrubber would be 40 gallons per minute (57,600 gal/day).

The Exide facility has an Industrial Wastewater Discharge Permit with a maximum 310,000 gallons per day limit and 300 gallons per minute limit. The daily wastewater peak discharge rate for the fiscal year 2011/2012 was 132,630 gallons per day based on the annual surcharge statement submitted by the company. The peak discharge rate of 236 gallons per minute is based on the average of the ten highest 30-minute peak flow periods (Personal communication with Los Angeles County Sanitation District, 2013).⁷

An increase of 40 gallons of wastewater discharged per minute would increase the peak discharge rate to 276 gallons of wastewater discharged per minute (40 gallons per minute + 236 gallons per minute), which would be less than the maximum permitted wastewater discharge rate of 300 gallons per minute for the existing wastewater system. The addition of 57,600 gallons per day of wastewater discharged (40 gallons of wastewater discharged per minute) would result in an average facility wastewater discharge rate of 190,230 gallons per day (132,630 gal/day + 57,600 gal/day), which would be less than the permit maximum wastewater discharge rate of 310,000 gallons per day, so no change to current permit is required. In addition, the increased peak daily discharge volume (from 132,630 gallons per day in the existing condition compared to 190,230 gallons per day during operation) is not a significant impact on the wastewater infrastructure. This analysis is summarized in Table 2-23.

**Table 2-23
Wastewater Discharge**

Description	Measured	Proposed Project	Total	Limit	Significant?
Flow Rate, gal/min	236	40	276	300	No
Flow Rate, gal/day	132,630	57,600	190,230	310,000	No

If the proposed project does require a wastewater discharge rate that exceeds the 310,000 gallons per day limit, the Los Angeles County Sanitation District deems that a secondary peak permit could be required to allow discharge during non-peak hours.⁶ Significance for industrial wastewater discharge is determined by its impact to the affected sewer system. The Los Angeles County Sanitation District said as long as hydraulic overloading of the sewer system does not occur downstream of the Exide facility there is available capacity to accommodate flows greater than the permitted maximum discharge rates.⁶ However, wastewater flow can be affected by relief or repair work, but no relief or repair work in the near future was identified by the Los Angeles County Sanitation District. Based on the existing sewer system used by the Exide facility, the Los Angeles County Sanitation District believes that an additional 300 gallons per minute can be accommodated by the existing sewer system.⁶

⁷ Personal communication with Los Angeles County Sanitation District on June 28, 2013.

Therefore, based on the above analysis, there would be adequate capacity to serve the proposed project’s projected demand addition to the provider’s existing commitments.

Based upon these considerations, significant adverse hydrology and water quality impacts are not anticipated.

	Potentially Significant Impact	Less Than Significant With Mitigation	Less Than Significant Impact	No Impact
X. LAND USE AND PLANNING.				
Would the project:				
a) Physically divide an established community?	<input type="checkbox"/>	<input type="checkbox"/>	<input type="checkbox"/>	<input checked="" type="checkbox"/>
b) Conflict with any applicable land use plan, policy, or regulation of an agency with jurisdiction over the project (including, but not limited to the general plan, specific plan, local coastal program or zoning ordinance) adopted for the purpose of avoiding or mitigating an environmental effect?	<input type="checkbox"/>	<input type="checkbox"/>	<input type="checkbox"/>	<input checked="" type="checkbox"/>

Significance Criteria

Land use and planning impacts will be considered significant if the project conflicts with the land use and zoning designations established by local jurisdictions.

Discussion

X. a) Like the project analyzed in the 2014 Final EA for Rule 1420.1, the proposed project would require the installation of control technology and associated supporting equipment at the existing Exide facility. All construction activities would occur on-site. Changes to operations would include operation of the control technology and associated supporting equipment to reduce arsenic, lead, benzene, and 1,3-butadiene emissions. All changes to operations would also occur on-site. Therefore, the proposed project would not create divisions in any existing communities.

X. b) Land use and other planning considerations are determined by local governments. Construction and operation of the new control technologies would occur within the boundaries of the existing Exide facility in an area that is zoned for industrial use and no plans for land use expansion. The construction and operation of the new control technologies are not designed to impede or conflict with existing land use plan, policy, or regulation adopted for the purpose of avoiding or mitigating an environmental effect, but to assist in avoiding or mitigating arsenic, lead, benzene, and 1,3-butadiene impacts from the Exide facility. Operations at the Exide facility would still be expected to comply, and not interfere, with any applicable land use plans, zoning ordinances.

Based upon these considerations, significant adverse land use and planning impacts are not anticipated and, therefore, no further analysis is required or necessary.

	Potentially Significant Impact	Less Than Significant With Mitigation	Less Than Significant Impact	No Impact
XI. MINERAL RESOURCES. Would the project:				
a) Result in the loss of availability of a known mineral resource that would be of value to the region and the residents of the state?	<input type="checkbox"/>	<input type="checkbox"/>	<input type="checkbox"/>	<input checked="" type="checkbox"/>
b) Result in the loss of availability of a locally-important mineral resource recovery site delineated on a local general plan, specific plan or other land use plan?	<input type="checkbox"/>	<input type="checkbox"/>	<input type="checkbox"/>	<input checked="" type="checkbox"/>

Significance Criteria

Project-related impacts on mineral resources will be considered significant if any of the following conditions are met:

- The project would result in the loss of availability of a known mineral resource that would be of value to the region and the residents of the state.
- The proposed project results in the loss of availability of a locally-important mineral resource recovery site delineated on a local general plan, specific plan or other land use plan.

Discussion

XI. a) & b) There are no provisions in the proposed project that would result in the loss of availability of a known mineral resource of value to the region and the residents of the state such as aggregate, coal, clay, shale, et cetera, or of a locally-important mineral resource recovery site delineated on a local general plan, specific plan or other land use plan. The equipment would not remove any mineral resources of value to the region and the residents of the state.

Based upon these considerations, significant adverse mineral resources are not anticipated and, therefore, no further analysis is required or necessary.

	Potentially Significant Impact	Less Than Significant With Mitigation	Less Than Significant Impact	No Impact
XII. NOISE. Would the project result in:				
a) Exposure of persons to or generation of permanent noise levels in excess of standards established in the local general plan or noise ordinance, or applicable standards of other agencies?	<input type="checkbox"/>	<input type="checkbox"/>	<input checked="" type="checkbox"/>	<input type="checkbox"/>
b) Exposure of persons to or generation of excessive groundborne vibration or groundborne noise levels?	<input type="checkbox"/>	<input type="checkbox"/>	<input checked="" type="checkbox"/>	<input type="checkbox"/>
c) A substantial temporary or periodic increase in ambient noise levels in the project vicinity above levels existing without the project?	<input type="checkbox"/>	<input type="checkbox"/>	<input checked="" type="checkbox"/>	<input type="checkbox"/>
d) For a project located within an airport land use plan or, where such a plan has not been adopted, within two miles of a public use airport or private airstrip, would the project expose people residing or working in the project area to excessive noise levels?	<input type="checkbox"/>	<input type="checkbox"/>	<input type="checkbox"/>	<input checked="" type="checkbox"/>

Significance Criteria

Impacts on noise will be considered significant if:

- Construction noise levels exceed the local noise ordinances or, if the noise threshold is currently exceeded, project noise sources increase ambient noise levels by more than three decibels (dBA) at the site boundary. Construction noise levels will be considered significant if they exceed federal Occupational Safety and Health Administration (OSHA) noise standards for workers.
- The proposed project operational noise levels exceed any of the local noise ordinances at the site boundary or, if the noise threshold is currently exceeded, project noise sources increase ambient noise levels by more than three dBA at the site boundary.

Discussion

XI. a) & c) Noise is usually defined as sound that is undesirable because it interferes with speech communication and hearing, is intense enough to damage hearing, or is otherwise annoying (unwanted noise). Sound levels are measured on a logarithmic scale in decibels (dB). The universal measure for environmental sound is the "A" weighted sound level (dBA), which is the sound pressure level in decibels as measured on a sound level meter using the A-weighted filter network. "A" scale weighting is a set of mathematical factors applied by the measuring instrument to shape the frequency content of the sound in a manner similar to the way the human ear responds to sounds.

Federal, state and local agencies regulate environmental and occupational, as well as, other aspects of noise. Federal and state agencies generally set noise standards for mobile sources, while regulation of stationary sources is left to local agencies. Local regulation of noise involves

implementation of General Plan policies and Noise Ordinance standards, which are general principles, intended to guide and influence development plans. Noise Ordinances set forth specific standards and procedures for addressing particular noise sources and activities. The Occupational Safety and Health Administration (OSHA) sets and enforces noise standards for worker safety.

Existing operational noise generated from the Exide facility in the City of Vernon would be subject to the City of Vernon Noise Element of the General Plan and/or the City of Vernon Municipal Code. Table 2-24 summarizes these requirements.

**Table 2-24
City of Vernon Noise Requirements**

Requirement	Construction Limit (dBA)
Noise Element of the General Plan of the City of Vernon	60-70 dBA CNEL or less - considered "normally compatible" for residential land use. 70-80 dBA CNEL - considered "normally compatible" for industrial use".
City of Vernon Municipal Code Chapter 26, §26.4.1-6	Requires that noise levels generated by construction equipment within a residential zone not exceed 75 dBA.

The proposed project affects the Exide facility in the City of Vernon and as explained below, actions taken to comply with the proposed project would not generate excessive noise levels outside the boundaries of the affected facility, or expose people residing or working in the project area to excessive noise levels. The proposed project requires no additional equipment to the existing facilities which would cause noise level to exceed ambient levels. Air pollution control equipment, such as RTOs and scrubbers are not typically noise generating equipment.

Construction-Related Noise

Table 2-25 presents construction noise levels from typical construction equipment that would be needed to install the new control equipment, ventilation hoods, scrubber, etc. Based on Table 2-25, paver noise levels are around 85 dBA at 50 feet. Construction would increase the noise levels to around 85 dBA at 50 feet from the center of construction activity. The facility would need to install air pollution control equipment and the closest residences are about 1,400 meters north of the facility. Using the standard of an estimated six dBA reduction for every doubling in distance, the noise levels at the closest residence would be indistinguishable from background. At a distance of 1,400 meters (4,593 feet), the noise impacts are negligible. For example, at the highest level in Table 2-25 (85 dBA), the sound would be reduced to below the municipal code of (75 dBA) at 200 feet away and General Plan level (70 dBA) at 400 feet away. In general, given ambient noise levels near the affected facility, noise attenuation (the lowering of noise levels over distances), and compliance with local noise ordinances, potential construction noise impacts are not expected to be significant.

In addition, all equipment is expected to be placed within existing buildings/enclosures at Exide and the only portions of the construction that is expected to occur outside of the buildings/enclosures are the use of cranes to replace the scrubber stack and stack structural

support on the exterior of buildings. Most of the construction would occur within existing buildings/enclosures would further attenuate any construction noise.

**Table 2-25
Construction Noise Sources**

Equipment	Typical Range (decibel)	Analysis Value (decibel)
Cranes	75-89	83
Front Loader	73-86	82
Generator Sets	71-83	81
Pavers	85-88	85
Scraper, Graders	80-93	80
Truck	82-92	82

Typical ranges are from the City of Los Angeles, 1998. Levels are in dBA at 50-foot reference distance. Analysis values are intended to reflect noise levels from equipment in good condition, which appropriate mufflers, air intake silencers, etc. In addition, these values assume averaging of sound level over all directions from the listed piece of equipment.

Operational Noise

Noise is a by-product of the existing lead-acid battery recycling operations. Employees and equipment at the existing affected facility currently perform activities which create noise, such as, raw material processing (battery breaking/crushing, charger preparation, rotary drying, sweating), smelting (furnaces), refining and casting, and truck loading/unloading. Control technology, such as, RTOs and scrubbers as explained below are not expected to generate noise greater than the existing lead-acid battery recycling operations. Noise ordinances and noise general plan requirements typically govern activities at existing facilities. Contributors to ambient noise levels at the facility include onsite equipment and mobile sources. In addition, the Exide facility operations currently include diesel truck traffic to deliver recycled batteries and ship recycled lead product. Also, local noise levels are usually governed by noise elements within a local jurisdiction's General Plan, and/or local noise ordinances. Because of the attenuation rate of noise based on distance from the source, and since all air pollution control equipment would be placed within existing buildings or structures, it is unlikely that noise levels exceeding local noise ordinances would occur beyond a facility's boundaries. The existing scrubber and ram feeding system at the Exide facility cannot be heard offsite over the existing noise generated, so the two RTOs, screw feeding system, and new scrubber are not expected to generate noise above existing background noise as well. Therefore, the proposed project is not expected to generate new significant adverse operational noise.

XI. b)

Construction-Related Vibration

The Federal Transit Administration (FTA) has published standard vibration levels and peak particle velocities for construction equipment operations (FTA, 2006). The approximate velocity level and peak particle velocities for large construction equipment are listed in Table 2-26. Groundborne vibration is quantified in terms of decibels, since that scale compresses the range of numbers required to describe the oscillations. The FTA uses vibration decibels (abbreviated as VdB) to measure and assess vibration amplitude. Vibration is referenced to one micro-inch/sec (converted to 25.4 micro-mm/sec in the metric system) and presented in units of VdB. Based on

the activities and equipment which would be used during control technology construction phases, the construction equipment source levels are estimated to range between 58 VdB and 100 VdB at a distance of 25 feet. When analyzing ground-borne vibration, the FTA recommends using an estimated six VdB reduction for every doubling of distance.⁸ Using the FTA methodology, the groundborne vibration levels at the closest worker receptor (100 meters or 328 feet) would be negligible (e.g., at 328 feet the bulldozer would generated a velocity level of 9 VdB = 87 VdB – (13 x 6 VdB)). To put into context, the predicted vibration during construction activities can be compared to the FTA ground-borne vibration impact level of 72 VdB for residences and buildings where people normally sleep. Levels of vibration below the FTA ground-borne vibration impact level are considered less than significant by the FTA. Therefore, because the vibration from construction activities affecting workers and residences is less than the FTA vibration impact level, no significant vibration impacts are expected during the construction period.

**Table 2-26
Construction Vibration Sources**

Equipment	Approximate Peak Particle Velocity at 25 Feet (inch/second)	Approximate Vibration Level at 25 Feet (VdB)
Bulldozer, Large	0.089	87
Bulldozer, Small	0.003	58
Jackhammer	0.035	79
Loaded Truck	0.076	86

Typical ranges are from the City of Los Angeles, 1998. Levels are in dBA at 50-foot reference distance. Analysis values are intended to reflect noise levels from equipment in good condition, with appropriate mufflers, air intake silencers, etc. In addition, these values assume averaging of sound level over all directions from the listed piece of equipment.

Operational Vibration

Vibration is also a by-product of the existing lead-acid battery recycling operations. Employees and equipment at the existing affected facility currently perform activities which create vibration, such as, raw material processing (battery breaking/crushing, charger preparation, rotary drying, sweating), smelting (furnaces), refining and casting, and truck loading/unloading. Screw feeders and control technology, such as, RTOs and scrubbers; however, are not expected to generate vibration, as equipment is secured and bolted to the foundation and the existing scrubber does not generate vibrations noticeable from offsite. Therefore, the proposed project is not expected to generate new significant adverse operational vibration.

XI. d) Exide is not near any airports or private airstrips. The closest airport or airstrip is the Compton/Woodley Airport (901 W Alondra Blvd, Compton, CA), which is 8.7 miles from the affected facility. Therefore, the proposed project would not expose people residing or working in the project area to excessive noise levels within two miles of a public use airport or private airstrip.

Based upon these considerations, significant adverse noise impacts are not anticipated.

⁸ Office of Planning and Environment Federal Transit Administration, Transit Noise and Vibration Impact Assessment , FTA-VA-90-1003-06, 2006.

	Potentially Significant Impact	Less Than Significant With Mitigation	Less Than Significant Impact	No Impact
--	--------------------------------	---------------------------------------	------------------------------	-----------

XIII. POPULATION AND HOUSING.

Would the project:

- | | | | | |
|---|--------------------------|--------------------------|--------------------------|-------------------------------------|
| a) Induce substantial growth in an area either directly (for example, by proposing new homes and businesses) or indirectly (e.g. through extension of roads or other infrastructure)? | <input type="checkbox"/> | <input type="checkbox"/> | <input type="checkbox"/> | <input checked="" type="checkbox"/> |
| b) Displace substantial numbers of people or existing housing, necessitating the construction of replacement housing elsewhere? | <input type="checkbox"/> | <input type="checkbox"/> | <input type="checkbox"/> | <input checked="" type="checkbox"/> |

Significance Criteria

Impacts of the proposed project on population and housing will be considered significant if the following criteria are exceeded:

- The demand for temporary or permanent housing exceeds the existing supply.
- The proposed project produces additional population, housing or employment inconsistent with adopted plans either in terms of overall amount or location.

Discussion

XIII. a) The proposed project would require the installation of control technology and support equipment at the Exide facility. All construction and operation would occur on-site. The proposed project is not anticipated to generate any significant effects, either direct or indirect, on the district's population or population distribution as no additional permanent workers are anticipated to be required to comply with the proposed amendments. Human population within the jurisdiction of the SCAQMD is anticipated to grow regardless of the proposed project. It is expected that any construction activities at the affected facility would use construction workers from the local labor pool in Southern California. Any new equipment is expected to be operated by qualified existing employees at the affected facility. As such, the proposed project would not result in changes in population densities or induce significant growth in population.

XIII. b) Because the proposed project affects construction and operation of control equipment at the Exide facility, it is not expected to result in the creation of any industry that would affect population growth, directly or indirectly, induce the construction of single- or multiple-family units, or require the displacement of people elsewhere.

Based upon these considerations, significant adverse population and housing impacts are not anticipated and, therefore, no further analysis is required or necessary.

Potentially Significant Impact	Less Than Significant With Mitigation	Less Than Significant Impact	No Impact
--------------------------------------	--	------------------------------------	-----------

XIV. PUBLIC SERVICES. Would the proposal result in substantial adverse physical impacts associated with the provision of new or physically altered governmental facilities, need for new or physically altered government facilities, the construction of which could cause significant environmental impacts, in order to maintain acceptable service ratios, response times or other performance objectives for any of the following public services:

- | | | | | |
|-----------------------------|--------------------------|--------------------------|--------------------------|-------------------------------------|
| a) Fire protection? | <input type="checkbox"/> | <input type="checkbox"/> | <input type="checkbox"/> | <input checked="" type="checkbox"/> |
| b) Police protection? | <input type="checkbox"/> | <input type="checkbox"/> | <input type="checkbox"/> | <input checked="" type="checkbox"/> |
| c) Schools? | <input type="checkbox"/> | <input type="checkbox"/> | <input type="checkbox"/> | <input checked="" type="checkbox"/> |
| d) Other public facilities? | <input type="checkbox"/> | <input type="checkbox"/> | <input type="checkbox"/> | <input checked="" type="checkbox"/> |

Significance Criteria

Impacts on public services will be considered significant if the project results in substantial adverse physical impacts associated with the provision of new or physically altered governmental facilities, or the need for new or physically altered government facilities, the construction of which could cause significant environmental impacts, in order to maintain acceptable service ratios, response time or other performance objectives.

Discussion

XIV. a) & b) As discussed in the Hazards Section, the proposed project would not involve the use of new flammable or combustible materials. The replacement RTOs are expected to be commercial units. Commercial units are typically certified, listed or marked by safety organizations such as Underwriters Laboratories (UL), ETL Mark, and Conformité Européenne (CE). Equipment certified, listed or marked by safety organizations have met rigorous electrical and fire safety standards. Because the RTOs are commercial units and the nearest receptors are 100 meters away from the facility (100 meters from worker receptors and 1,400 meters from residential receptors), the risk of fire hazards from the RTOs are expected to be less than significant.

As a result, no new fire hazards or increased use of hazardous materials would be introduced at the existing affected facility that would require additional emergency responders such as police or fire departments or additional demand from these resources. Thus, no new demands for fire or police protection are expected from the proposed project.

XIV. c) As noted in the “Population and Housing” discussion, implementation of the proposed project would not require employees from outside the region for construction because construction workers from the local labor pool in southern California would be used. Similarly, no new permanent employees would be required because the control equipment is expected to be

operated by qualified existing employees. As a result, the proposed project would have no direct or indirect effects on population growth in the district. Therefore, there would be no increase in local population and thus no impacts are expected to local schools as a result of the proposed project.

XIV. d) Because the proposed project involves requirements that are similar to existing operations already in place at an existing facility and the facilities are already heavily regulated, it is not expected to require the need for additional government services. Permits for the air pollution control equipment required for the proposed project are expected to be issued by existing permit staff. Any building permits are expected to be issued by existing City of Vernon staff. Enforcement of the permits is expected to be performed by the existing SCAQMD inspectors for these facilities. Further, the proposed project would not result in the need for new or physically altered government facilities in order to maintain acceptable service ratios, response times, or other performance objectives. There will be no increase in population and, therefore, no need for physically altered government facilities.

Based upon these considerations, significant adverse public services impacts are not anticipated.

	Potentially Significant Impact	Less Than Significant With Mitigation	Less Than Significant Impact	No Impact
XV. RECREATION.				
a) Would the project increase the use of existing neighborhood and regional parks or other recreational facilities such that substantial physical deterioration of the facility would occur or be accelerated?	<input type="checkbox"/>	<input type="checkbox"/>	<input type="checkbox"/>	<input checked="" type="checkbox"/>
b) Does the project include recreational facilities or require the construction or expansion of recreational facilities that might have an adverse physical effect on the environment or recreational services?	<input type="checkbox"/>	<input type="checkbox"/>	<input type="checkbox"/>	<input checked="" type="checkbox"/>

Significance Criteria

Impacts to recreation will be considered significant if:

- The project results in an increased demand for neighborhood or regional parks or other recreational facilities.
- The project adversely affects existing recreational opportunities.

Discussion

XV. a) & b) As previously discussed under “Land Use,” there are no provisions in the proposed project that would affect land use plans, policies, or regulations. Land use and other planning considerations are determined by local governments; no land use or planning requirements would be altered by the proposed project. Further, the proposed project would only involve the

installation and operation of air pollution control equipment, it would not increase the use of existing neighborhood and regional parks or other recreational facilities or include recreational facilities or require the construction or expansion of recreational facilities that might have an adverse physical effect on the environment because the proposed project is not expected to induce population growth as discussed in the Population and Housing Section.

Based upon the above considerations, significant adverse recreation impacts are not anticipated and, therefore, no further analysis is required or necessary.

	Potentially Significant Impact	Less Than Significant With Mitigation	Less Than Significant Impact	No Impact
XVI. SOLID/HAZARDOUS WASTE.				
Would the project:				
a) Be served by a landfill with sufficient permitted capacity to accommodate the project's solid waste disposal needs?	<input type="checkbox"/>	<input type="checkbox"/>	<input checked="" type="checkbox"/>	<input type="checkbox"/>
b) Comply with federal, state, and local statutes and regulations related to solid and hazardous waste?	<input type="checkbox"/>	<input type="checkbox"/>	<input checked="" type="checkbox"/>	<input type="checkbox"/>

Significance Criteria

The proposed project impacts on solid/hazardous waste will be considered significant if the following occurs:

- The generation and disposal of hazardous and non-hazardous waste exceeds the capacity of designated landfills.

Discussion

XVI.a) Landfills are permitted by the local enforcement agencies with concurrence from the California Department of Resources Recycling and Recovery (CalRecycle). Local agencies establish the maximum amount of solid waste which can be received by a landfill each day and the operational life of a landfill. Like the project evaluated in the 2014 Final EIR for Rule 1420.1, the proposed project would generate additional waste from the disposal of spent arsenic and lead captured by new control technology that is discussed in further detail in the following paragraphs.

Construction

Analysis in the 2014 Final EA for Rule 1420.1

The analysis in the 2014 Final EA for Rule 1420.1 assumed replacement of an existing scrubber with a new scrubber. The replaced scrubber was expected to be recycled. Any parts of the scrubber that were not recycled are expected to be decontaminated and disposed in a Class III landfill. The analysis anticipated the only demolition would be of the existing scrubber stack and support structure, but the existing scrubber would not be demolished (i.e., would still be

used). Since the demolition of the entire existing scrubber was not expected to be significant, a limited demolition would also not be significant.

The analysis in the 2014 Final EA for Rule 1420.1 did not assume demolition of foundations for the existing scrubber or for installation of the replacement scrubber, but it did include the demolition of existing surfaces and site preparation and grading for foundations for a new wet ESP at an existing affected facility. Approximately, 8,150 cubic yards of material (two acres of area approximately two yards deep) was expected to result from the demolished storm water retention pond, if a wet ESP was installed. Construction material was not expected to be contaminated, since the surfaces are required to be cleaned daily according to the original Rule 1420.1.

Based on the 2012 AQMP there is approximately 116,796 tons per day of landfill space available in the district. Therefore, the addition of 8,150 cubic yards of material ($8,150 \text{ yd}^3 \times 150 \text{ lb/ft}^3 \times 27 \text{ ft}^3/\text{yd}^3 \times \text{ton}/2,000 \text{ lb}$)/16.3 demolition days = 1,013 ton/day) of demolished material (0.8 percent of the daily capacity available) was not expected to be a significant adverse impact to solid waste impact from the construction phase of the proposed project. In addition, most of the demolition material from the storm water retention pond was expected to be concrete, which can be recycled. Therefore, realistically the amount of material disposed was expected to be much less than 1,013 tons per day.

Proposed Project

The metal from the demolished scrubber stack and supports, and the ram feeder is expected to be recycled. Therefore, very little waste is expected from the demolition of this equipment. Construction related to the proposed project would require the removal of flooring for new foundations for the new scrubber and RTOs. These areas have been previously disturbed since there is an existing floor that needs to be removed and replaced with a new foundation capable of supporting the new scrubber and support equipment. The area of existing floor would be much less than the 8,150 cubic yards of material to be removed. Exide facility representatives estimated that 720 cubic yards would be removed (scrubber stack, scrubber stack support, ram feeder, concrete flooring, soil, etc). Therefore, the demolition of flooring for the new scrubber, RTOs and related support structures is not expected to be significant, because it would be less than that analyzed in the 2014 Final EA for Rule 1420.1 which was also less than significant.

Soil at the affected facility has been identified as contaminated with metals, primarily arsenic and lead. The analysis in the 2014 Final EA for Rule 1420.1 assumed that demolition hazardous waste would be taken to either to the Chemical Waste Management Kettleman Hills Landfill or the Clean Harbors Buttonwillow Landfill for treatment and disposal. There will be 320 cubic yards of soil and concrete transported, as they have done in previous projects, to the Chiquita Canyon Sanitary Landfill in Castaic, California if non-hazardous waste; to the Republic Services La Paz County Landfill in Parker, Arizona if considered a California hazardous waste; or to the US Ecology Inc., facility in Beatty, Nevada if considered a RCRA hazardous waste.

Since the destination of the waste would not be known until it is characterized, the adverse impact of sending the entire 320 cubic yards of soil and concrete expected to be excavated from the proposed project to each of the facilities was evaluated to ensure the worst-case scenario was analyzed.

The Republic Services La Paz County Landfill has approximately 20,000,000 cubic yards of capacity remaining for the 50 year life expectancy (400,000 cubic yards per year). The addition of 320 cubic yards of soil and concrete would be 0.07 percent of the 400,000 cubic yards of hazardous waste capacity available annually at the Republic Services La Paz County Landfill.

The US Ecology, Inc., facility in Beatty, Nevada has approximately 638,858 cubic yards of capacity remaining for the three year life expectancy (212,952 cubic yards per year. US Ecology, Inc., receives approximately 18,000 cubic yards per year of waste, so 194,952 cubic yards per year (212,952 cubic yard/year – 18,000 cubic yard/year) would be available. The addition of 320 cubic yards of soil and concrete would be 0.2 percent of the 212,952 cubic yards of hazardous waste capacity available annually at the US Ecology, Inc., facility.

The Chiquita Canyon Sanitary Landfill in Castaic, California has approximately 22,400,000 cubic yards of capacity remaining with a closure date of November 24, 2019 and a maximum permitted throughput of 6,000 tons per day. An estimated total of 320 tons of concrete would be excavated and disposed of in 27 truck trips with up to two truck trips per day. The addition of 44 tons per day (22 ton/ truck x 8 truck trips/day) of non-hazardous concrete would be 0.007 percent of the 6,000 tons per day maximum throughput.

Therefore, the increase in solid or hazardous waste disposal from the proposed project is expected to be less than significant for construction hazardous waste disposal.

Operational

The additional arsenic and lead recovered from the wastewater treatment system would be placed into the lead-acid battery recovery process to be recycled; therefore, most of the arsenic and lead from the wastewater treatment system would not be disposed at solid waste landfills. However, arsenic and lead bearing slag that is not recycled would be sent off-site for disposal. Therefore, it is expected that the proposed project would not substantially change hazardous waste handling but may minimally increase disposal volumes.

2014 Final EA for Rule 1420.1

Hazardous solid waste from the affected facility is currently sent to Republic Services La Paz County Landfill in Parker, Arizona. The Republic Services La Paz County Landfill has approximately 20,000,000 cubic yards of capacity remaining for the 50 year life expectancy (400,000 cubic yards per year).

In 2010, the arsenic emission rate reported in the annual emissions inventory report for the affected facility was 3.6 pounds per year with a total reported metal emission rate of 622 pounds per year. In 2011, the arsenic emission rate reported in the annual emissions inventory report was 1,202 pounds per year with a total reported metal emission rate of 1,768 pounds per year. In 2012, the arsenic emission rate reported in the annual emissions inventory report was 197 pounds per year with a total reported metal emission rate of 458 pounds per year. Like the analysis in the 2014 Final EA for Rule 1420.1, it is assumed that the proposed project would reduce arsenic and metal emission rates to those reported in 2010. The annual emissions inventory report values are presented in Table 2-27. Based on the difference between the metal emission rates of the highest year (2011) and lowest year (2012) approximately 1,146 pounds of year (1,768 to 622 pounds per year) would be captured at the affected facility, and required to be disposed of as hazardous waste.

**Table 2-27
Metal Emissions for Reporting Years 2010 to 2012**

Reporting Year	Arsenic Emissions, lb/yr	Total Metal Emissions, lb/yr
2010	3.6	622
2011	1,202	1,768
2012	197	458

Metals caught by air pollution control devices are returned to the recycling process. However, to be conservative, it was assumed that all 1,146 pounds of metal emission captures would be sent to hazardous waste landfills. Arsenic and lead emissions make up approximately 98 to 99 percent of the metal emissions reported in the annual emissions inventory report for the affected facility. Using the densities of arsenic and lead as boundaries (lead: 707.93 lb/ft³, arsenic: 357.53 lb/ft³), the volume of hazardous metals captured would be between two to four cubic feet of metal per year based on a reduction of 1,410 pounds of metal emissions per year. The addition of two to four cubic feet of metal sent to hazardous waste disposal facilities per year would be 0.001 percent of the 400,000 cubic yards of hazardous waste capacity available annually at the Republic Services La Paz County Landfill. Therefore, the increase in hazardous waste disposal from the proposed project is expected to be less than significant for operational hazardous waste disposal.

Proposed Project

The proposed project is not expected to change the amount of hazardous waste from spent metals analyzed in the 2014 Final EA for Rule 1420.1, so the impact would remain not significant. The proposed project is also expected to generate hazardous waste from the disposal of filters from the repurposed baghouse and HEPA filters. The volume of the spent filters (143 cubic yards) was estimated from number and sizes of the pre-filters, HEPA filters and baghouse filters included in the permit application (see Appendix A). There are two locations that Exide sends hazardous waste. California hazardous waste is sent to the Republic Services La Paz County Landfill in Parker, Arizona and RCRA hazardous waste is sent to US Ecology, Inc., facility in Beatty, Nevada. Hazardous waste is characterized and sent to the appropriate hazardous waste facility.

The addition of two to four cubic feet of spent metal (analyzed in the 2014 Final EA for Rule 1420.1) and 143 cubic yards of filter media (proposed project) sent to hazardous waste disposal facilities per year would be 0.04 percent of the 400,000 cubic yards of hazardous waste capacity available annually at the Republic Services La Paz County Landfill. Therefore, since the total increase in hazardous waste disposal would be less than one percent of the available annual capacity at the Republic Services La Paz County Landfill, it is expected to be less than significant for operational hazardous waste disposal.

The addition of two to four cubic feet of spent metal (analyzed in the 2014 Final EA for Rule 1420.1) and 143 cubic yards of filter media (proposed project) sent to hazardous waste disposal facilities per year would be 0.07 percent of the 194,952 cubic yards of hazardous waste capacity available annually at the US Ecology, Inc., facility. The US Ecology Inc., facility is 80 acres in size and has three years of life expectancy at its current size. However, there is a 400 acre buffer area around the facility that US Ecology, Inc., expects to be able to utilize within the next three

years to continue operations. Therefore, since the total increase in hazardous waste disposal would be less than one percent of the available annual capacity at the US Ecology, Inc., facility and five times the existing facility acreage is expected to be available at this facility in the next three years, it is expected to be less than significant for operational hazardous waste disposal.

Therefore, the quantity and impacts from hazardous waste associated with the proposed project is not expected to differ from the amount and impacts from hazardous waste analyzed in the 2014 Final EA for Rule 1420.1. Therefore, the proposed project is not expected to be significant for adverse hazardous waste impacts related to hazardous waste capacity.

XVI.b) Existing affected facility operators currently dispose of spent arsenic and lead from wastewater treatment systems. It is assumed that facility operators at the affected facility comply with all applicable local, state, or federal waste disposal regulations. Therefore, like the analysis in the 2014 Final EA for Rule 1420.1, it is assumed that the proposed project would not interfere with any affected facility's ability to comply with applicable local, state, or federal waste disposal regulations. Since no solid/hazardous waste impacts were identified, no mitigation measures are required or necessary.

Based upon these considerations, significant adverse solid/hazardous waste impacts are not anticipated.

	Potentially Significant Impact	Less Than Significant With Mitigation	Less Than Significant Impact	No Impact
XVII. TRANSPORTATION/TRAFFIC.				
Would the project:				
a) Conflict with an applicable plan, ordinance or policy establishing measures of effectiveness for the performance of the circulation system, taking into account all modes of transportation including mass transit and non-motorized travel and relevant components of the circulation system, including but not limited to intersections, streets, highways and freeways, pedestrian and bicycle paths, and mass transit?	<input type="checkbox"/>	<input type="checkbox"/>	<input type="checkbox"/>	<input checked="" type="checkbox"/>
b) Conflict with an applicable congestion management program, including but not limited to level of service standards and travel demand measures, or other standards established by the county congestion management agency for designated roads or highways?	<input type="checkbox"/>	<input type="checkbox"/>	<input type="checkbox"/>	<input checked="" type="checkbox"/>
c) Result in a change in air traffic patterns, including either an increase in traffic levels or a change in location that results in substantial safety risks?	<input type="checkbox"/>	<input type="checkbox"/>	<input type="checkbox"/>	<input checked="" type="checkbox"/>
d) Substantially increase hazards due to a design feature (e.g. sharp curves or dangerous intersections) or incompatible uses (e.g. farm equipment)?	<input type="checkbox"/>	<input type="checkbox"/>	<input type="checkbox"/>	<input checked="" type="checkbox"/>
e) Result in inadequate emergency access?	<input type="checkbox"/>	<input type="checkbox"/>	<input type="checkbox"/>	<input checked="" type="checkbox"/>
f) Conflict with adopted policies, plans, or programs regarding public transit, bicycle, or pedestrian facilities, or otherwise decrease the performance or safety of such facilities?	<input type="checkbox"/>	<input type="checkbox"/>	<input type="checkbox"/>	<input checked="" type="checkbox"/>

Significance Criteria

Impacts on transportation/traffic will be considered significant if any of the following criteria apply:

- Peak period levels on major arterials are disrupted to a point where level of service (LOS) is reduced to D, E or F for more than one month.

- An intersection's volume to capacity ratio increase by 0.02 (two percent) or more when the LOS is already D, E or F.
- A major roadway is closed to all through traffic, and no alternate route is available.
- The project conflicts with applicable policies, plans or programs establishing measures of effectiveness, thereby decreasing the performance or safety of any mode of transportation.
- There is an increase in traffic that is substantial in relation to the existing traffic load and capacity of the street system.
- The demand for parking facilities is substantially increased.
- Water borne, rail car or air traffic is substantially altered.
- Traffic hazards to motor vehicles, bicyclists or pedestrians are substantially increased.
- The need for more than 350 employees
- An increase in heavy-duty transport truck traffic to and/or from the facility by more than 350 truck round trips per day
- Increase customer traffic by more than 700 visits per day.

Discussion

XVII. a) & b)

Analysis from the 2014 Final EA for Rule 1420.1

In the 2014 Final EA for Rule 1420.1, it was estimated that 19 haul trucks and seven construction worker trips on a peak construction day (during the fill phases) would occur at Exide, which were associated with demolition of the storm water retention pond. Construction onsite is not expected to affect on-site traffic or parking. The additional nineteen construction trips are less than the SCAQMD significance threshold of 350 round trips, therefore construction activities are not expected to cause a significant adverse impact to traffic or transportation.

During operation, the proposed project operations may require 16 additional trips annually (ten truck trips related to additional filter media replacement, one truck trip related to additional spent metal disposal and two truck trips related to replacement of thermal media and three additional gasoline fueled vehicle source testing trips). However, the addition of 16 new off-site trips is not expected to result in significant adverse transportation/traffic impacts.

Proposed Project

Based on construction data from Exide representatives' approximately 63 construction round trips may be required on a peak day (60 construction work trips and three heavy duty truck trips. This is greater than the 26 round trips estimated in the 2014 Final EA for Rule 1420.1. However the 63 round trips is less than the significance threshold of 350 round trips. Therefore, construction related trips from the proposed project are expected to be less than significant.

Like the project analyzed by the 2014 Final EA for Rule 1420.1, all operational activities related to proposed project are expected to occur on-site with the exception of three source test trips, an additional haul trip per year to dispose of spent arsenic and lead, five haul truck trips and five delivery trips to replace filter media, and two truck trips to replace thermal media every four to five years. However, the addition of sixteen new off-site round trips in a peak year are not expected to result in transportation/traffic impacts.

XVII. c) The affected facility is not near any airports or private airstrips. The closest airport or airstrip is the Compton/Woodley Airport (901 W Alondra Blvd, Compton, CA), which is 8.7 miles from the affected facility. The proposed project is not expected to influence or affect air

traffic patterns or navigable air space, since no new structures or equipment are expected to enter air space used by aircraft. Thus, the proposed project would not result in a change in air traffic patterns including an increase in traffic levels or a change in location that results in substantial safety risks.

XVII. d) & e) The proposed project does not involve construction of any roadways or other transportation design features, so there would be no change to current roadway designs that could increase traffic hazards. The siting of the affected facility is consistent with surrounding land uses and traffic/circulation in the surrounding areas of the affected facility. Thus, the proposed project is not expected to substantially increase traffic hazards or create incompatible uses at or adjacent to the affected facility. Emergency access at the affected facility is not expected to be impacted by the proposed project. Further, each affected facility is expected to continue to maintain their existing emergency access. Since the proposed project involves short-term construction activities and operation of control equipment is not expected to increase worker vehicle trips, the proposed project is not expected to alter the existing long-term circulation patterns. The proposed project is not expected to require a modification to circulation, thus, no long-term impacts on the traffic circulation system are expected to occur.

XVII. f) The affected facility would still be expected to comply with, and not interfere with adopted policies, plans, or programs supporting alternative transportation (e.g. bicycles or buses). Since all the proposed project compliance activities would occur on-site, it would not hinder compliance with any applicable alternative transportation plans or policies.

Based upon these considerations, significant adverse transportation/traffic impacts are not anticipated.

	Potentially Significant Impact	Less Than Significant With Mitigation	Less Than Significant Impact	No Impact
XVIII. MANDATORY FINDINGS OF SIGNIFICANCE.				
a) Does the project have the potential to degrade the quality of the environment, substantially reduce the habitat of a fish or wildlife species, cause a fish or wildlife population to drop below self-sustaining levels, threaten to eliminate a plant or animal community, reduce the number or restrict the range of a rare or endangered plant or animal or eliminate important examples of the major periods of California history or prehistory?	<input type="checkbox"/>	<input type="checkbox"/>	<input type="checkbox"/>	<input checked="" type="checkbox"/>

	Potentially Significant Impact	Less Than Significant With Mitigation	Less Than Significant Impact	No Impact
b) Does the project have impacts that are individually limited, but cumulatively considerable? ("Cumulatively considerable" means that the incremental effects of a project are considerable when viewed in connection with the effects of past projects, the effects of other current projects, and the effects of probable future projects)	<input type="checkbox"/>	<input type="checkbox"/>	<input checked="" type="checkbox"/>	<input type="checkbox"/>
c) Does the project have environmental effects that will cause substantial adverse effects on human beings, either directly or indirectly?	<input type="checkbox"/>	<input type="checkbox"/>	<input checked="" type="checkbox"/>	<input type="checkbox"/>

Discussion

XVIII. a) As discussed in the “Biological Resources” section, the proposed project is not expected to significantly adversely affect plant or animal species or the habitat on which they rely because any construction and operational activities associated with affected sources are expected to occur entirely within the boundaries of existing developed facilities in areas that have been greatly disturbed and that currently do not support any species of concern or the habitat on which they rely. The proposed project is not expected to reduce or eliminate any plant or animal species or destroy prehistoric records of the past.

XVIII. b) Based on the foregoing analyses, the proposed project would not result in significant adverse project-specific environmental impacts except for Hazards and Hazardous Waste related to potential contaminated soil from demolition of the existing foundation where the new scrubber and RTOs would be installed. However, mitigation measure **MMHAZ-01** would reduce this potential adverse significant impact to less than significant by removing soil to the closure requirement depth of five feet and disposing all concrete and soil as hazardous waste. Since a mitigation measure (MMHAZ-01) is included as part of this proposed project a mitigation monitoring plan will be developed pursuant to CEQA Guidelines §15074(d).

Projects that exceed the project-specific significance thresholds are considered by the SCAQMD to be cumulatively considerable. This is the reason project-specific and cumulative significance thresholds are the same. Conversely, projects that do not exceed the project-specific thresholds are generally not considered to be cumulatively significant.

This approach was upheld by the Court in *Citizens for Responsible Equitable Environmental Development v. City of Chula Vista* (2011) 197 Cal. App. 4th 327, 334. The Court determined that where it can be found that a project did not exceed the South Coast Air Quality Management District’s established air quality significance thresholds, the City of Chula Vista properly concluded that the project would not cause a significant environmental effect, nor result in a cumulatively considerable increase in these pollutants. The court found this determination to be consistent with CEQA Guidelines §15064.7, stating, “The lead agency may rely on a threshold

of significance standard to determine whether a project will cause a significant environmental effect.” The court found that, “Although the project will contribute additional air pollutants to an existing nonattainment area, these increases are below the significance criteria...” “Thus, we conclude that no fair argument exists that the Project will cause a significant unavoidable cumulative contribution to an air quality impact.” As in *Chula Vista*, here the District has demonstrated, when using accurate and appropriate data and assumptions, that the project will not exceed the established South Coast Air Quality Management District significance thresholds. See also, *Rialto Citizens for Responsible Growth v. City of Rialto* (2012) 208 Cal. App. 4th 899. Here again the court upheld the South Coast Air Quality Management District’s approach to utilizing the established air quality significance thresholds to determine whether the impacts of a project would be cumulatively considerable. Thus, it may be concluded that the Project will not cause a significant unavoidable cumulative contribution to an air quality impact.

Therefore, potential adverse impacts from implementing the proposed project would not be "cumulatively considerable" as defined by CEQA Guidelines §15064(h)(1) for any environmental topic because there are no, or only minor incremental project-specific impacts that were concluded to be less than significant. Per CEQA Guidelines §15064(h)(4), the mere existence of significant cumulative impacts caused by other projects alone shall not constitute substantial evidence that the proposed project’s incremental effects are cumulatively considerable. SCAQMD cumulative significant thresholds are the same as project-specific significance thresholds. So the proposed project would be significant for cumulative impacts from hazardous and hazardous material without mitigation measures MMAQ-01, MMAQ-02, MMHAZ-01 and MMHAZ-02. However, since the proposed project would be less than significant with mitigation measures MMAQ-01, MMAQ-02, MMHAZ-01 and MMHAZ-02 on a project level, the proposed project would also be less than significant for cumulative impacts with mitigation measures MMAQ-01, MMAQ-02, MMHAZ-01 and MMHAZ-02.

XVIII. c) Based on the foregoing analyses, the proposed project is not expected to cause adverse effects on human beings for any environmental topic with mitigation measure MMHAZ-01. As previously discussed in items I through XVIII, the proposed project has no potential to cause significant adverse environmental effects.

APPENDIX A

ASSUMPTIONS AND CALCULATIONS

**Table A-1a
Demolition Emissions**

Foundation, Scrubber Support and Ducting Demolition		
Demolition Schedule	27	days^a

Description of Waste	Volume, cubic yards^a	Density, ton/cubic yard	Weight, ton^b
Recyclable decontaminated equipment, siding and ducting	400		220
Concrete	85	2.03	173
Soil	235	1.70	400

Equipment Type^a	No. of Equipment	hr/day	Crew Size
Concrete/Industrial Saws	2	7.0	6
Cranes	1	3.0	
Tractors/Loaders/Backhoes	3	7.0	

Construction Equipment Emission Factors									
Equipment Type^c	CO	NOx	PM10	PM2.5	VOC	SOx	CO2	CH4	NO2
	lb/hr	lb/hr	lb/hr	lb/hr	lb/hr	lb/hr	lb/hr	lb/hr	lb/hr
Concrete/Industrial Saws	0.402	0.526	0.041	0.038	0.092	0.001	59	0.008	0.000
Cranes	0.431	1.028	0.044	0.041	0.120	0.001	121	0.011	0.000
Tractors/Loaders/Backhoes	0.374	0.498	0.034	0.031	0.073	0.001	67	0.007	0.000

Fugitive Dust Material Handling			
Aerodynamic Particle Size Multiplier^d	Mean Wind Speed^e	Moisture Content^f	Debris Handledⁱ
	mph		ton/day
0.35	2	2.0	44

Table A-1a (Continued)
Demolition Emissions

Construction Vehicle (Mobile Source) Emission Factorsⁱ									
	CO	NOx	PM10	PM2.5	VOC	SOx	CO2	CH4	NO2
	lb/mile	lb/mile	lb/mile	lb/mile	lb/mile	lb/mile	lb/mile	lb/mile	lb/mile
Automobile	4.12E-03	3.41E-04	1.04E-04	4.41E-05	4.50E-04	8.22E-06	7.28E-01	2.01E-05	4.83E-06
Heavy-Duty Truck	3.98E-03	1.81E-02	5.40E-04	3.85E-04	7.84E-04	3.64E-05	3.76E+00	3.64E-05	2.56E-04

Number of Trips and Trip Length		
Vehicle	No. of One-Way Trips/Day^j	One-Way Trip Length^j (miles)
Automobile	6	20
Heavy-duty Truck (Recycled Material)	2	193

Incremental Increase in Combustion Emissions from Construction Equipment									
Equation: Emission Factor (lb/hr) x No. of Equipment x Work Day (hr/day) = Construction Emissions (lb/day)									
Equipment Type	CO	NOx	PM10	PM2.5	VOC	SOx	CO2	CH4	NO2
	lb/day	lb/day	lb/day	lb/day	lb/day	lb/day	lb/day	lb/day	lb/day
Concrete/Industrial Saws	5.63	7.36	0.58	0.53	1.28	0.01	819	0.12	0.306
Cranes	1.29	3.08	0.13	0.12	0.36	0.00	363	0.03	0.128
Tractors/Loaders/Backhoes	7.86	10.45	0.71	0.66	1.53	0.02	1,402	0.14	0.435
Total	14.8	20.9	1.43	1.31	3.18	0.03	2,584	0.29	0.87

Table A-1a (Continued)
Demolition Emissions

Incremental Increase in Fugitive Dust Emissions from Construction Equipment			
Material Handling ^k : $(0.0032 \times \text{Aerodynamic Particle Size Multiplier} \times (\text{wind speed (mph)/5})^{1.3}/(\text{moisture content}/2)^{1.4} \times \text{debris handled (ton/day)}) \times (1 - \text{control efficiency}) = \text{PM10 Emissions (lb/day)}$			
Description	Control Efficiency	PM10^m	PM2.5^m
	%	lb/day	lb/day
Material Handling (Demolition) ^l	61	0.01	0.002
Material Handling (Debris)	61	0.01	0.002
Total		0.02	0.004

Incremental Increase in Combustion Emissions from Onroad Mobile Vehicles									
Equation: Emission Factor (lb/mile) x No. of One-Way Trips/Day x 2 x Trip length (mile) = Mobile Emissions (lb/day)									
Vehicle	CO	NOx	PM10	PM2.5	VOC	SOx	CO2	CH4	NO2
	lb/day	lb/day	lb/day	lb/day	lb/day	lb/day	lb/day	lb/day	lb/day
Automobile	0.99	0.08	0.025	0.011	0.11	0.002	175	0.005	0.001
Haul Truck (Recycled Material)	3.2	0.26	0.080	0.034	0.35	0.0063	562	0.0155	0.0037
Total	4.2	0.3	0.11	0.04	0.46	0.01	737	0.02	0.00

Total Incremental Emissions from Construction Activities							
Sources	CO	NOx	PM10	PM2.5	VOC	SOx	CO2
	lb/day	lb/day	lb/day	lb/day	lb/day	lb/day	metric ton/year
Emissions	19	21	1.6	1.4	3.2	0.03	44
Significance Thresholdⁿ	550	100	150	55	75	150	
Exceed Significance?	NO	NO	NO	NO	NO	NO	

**Table A-1a (Concluded)
Demolition Emissions**

Notes:

- a) The amount of material demolished, equipment, haul truck size, duration of activity, etc. was estimated. Based demolished (existing scrubber stack, stack support, blast feeder, etc.) and amount of concrete and soil excavated.
- b) An estimated of 10 containers of recyclable metal could be filled and that haul trucks can carry 22 tons.
Therefore, a maximum of 220 tons would be recycled [(40 container x 1 truck/container x 22 ton/ truck).
Weight of soil or concrete, ton = volume, cubic yards x density, ton/cubic yard, where soil density is 2.03 ton/cubic yard and concrete density is 1.70 ton/cubic yard.
- c) Emission factors estimated using OFFROAD2011
- d) USEPA, AP-42, Jan 1995, Section 13.2.4 Aggregate Handling and Storage Piles, p 13.2.4-3 Aerodynamic particle size multiplier for < 10 µm
- e) Mean wind speed - maximum of daily average wind speeds reported in 1981 meteorological data.
- f) USEPA, Fugitive Dust Background Document and Technical Information Document for Best Available Control Measures, equation 2-13, p 2-28
- g) USEPA, Fugitive Dust Background Document and Technical Information Document for Best Available Control Measures, p 2-28.
- h) The decontamination area size can only fit two rollofs within the baghouse row enclosure area and that the amount of time required to dismantle, decontaminate, and/or excavate would limit the daily number of rollofs sent offsite to two containers. Trucks are limited to carrying 22 tons, so only 44 tons of material (22 ton/truck x 2 truck trips) is expected to be handled per day.
- i) Emission factors estimated using EMFAC2011 for the 2014 fleet year.
- j) Hazardous waste truck trip is 193 miles one-way to Basin boundary on route to La Paz Landfill, which would be the longest disposal trip length in SCAQMD for the proposed project. Workers are assumed to travel 20 miles one-way to work.
- k) USEPA, Fugitive Dust Background Document and Technical Information Document for Best Available Control Measures, equation 2-13, p 2-28.
- l) EPA suggests using the material handling equation for demolition emission estimates.
- m) Includes watering at least three times a day per Rule 403 (61% control efficiency)
- n) SCAQMD significance thresholds

**Table A-1b
Demolition Emissions in MDAQMD**

Demolition Hauling MDAQMD									
Demolition Schedule	15	days ^a							
	CO	NOx	PM10	PM2.5	VOC	SOx	CO2	CH4	NO2
	lb/mile	lb/mile	lb/mile	lb/mile	lb/mile	lb/mile	lb/mile	lb/mile	lb/mile
Heavy-Duty Truck ^a	3.98E-03	1.81E-02	5.40E-04	3.85E-04	7.84E-04	3.64E-05	3.76	3.64E-05	2.56E-04
Number of Trips and Trip Length									
Vehicle	No. of One-Way Trips/Day ⁱ	One-Way Trip Length ^j (miles)							
Heavy-duty Truck	2	157							
Incremental Increase in Combustion Emissions from Onroad Mobile Vehicles									
Equation: Emission Factor (lb/mile) x No. of One-Way Trips/Day x 2 x Trip length (mile) = Mobile Emissions (lb/day)									
Vehicle	CO	NOx	PM10	PM2.5	VOC	SOx	CO2	CH4	NO2
	lb/day	lb/day	lb/day	lb/day	lb/day	lb/day	lb/day	lb/day	lb/day
Haul Truck	2.5	11.4	0.34	0.24	0.49	0.023	2,358	0.023	0.16
Total Incremental Localized Emissions from Operational Activity									
Sources	CO	NOx	PM10	PM2.5	VOC	SOx	CO2		
Daily Emissions, lb/day	2.5	11.4	0.34	0.24	0.49	0.023	2,409		
Annual Emissions, ton/year	0.0188	0.085	0.0025	0.0018	0.0037	0.00017	18.1		
Daily Significance Threshold, lb/day	548	137	82	82	137	137	548,000		
Annual Significance Threshold, ton/yr^b	100	25	15	15	25	25	100,000		
Exceed Significance?	NO	NO	NO	NO	NO	NO	NO		

Notes:

a) Emission factors estimated using EMFAC2011 for the 2014 fleet year.

b) MDAQMD significance thresholds

**Table A-1c
Demolition Emissions in GBUAPCD**

Demolition Hauling MDAQMD										
Demolition Schedule	15	days ^a								
	CO	NOx	PM10	PM2.5	VOC	SOx	CO2	CH4	NO2	
	lb/mile	lb/mile	lb/mile	lb/mile	lb/mile	lb/mile	lb/mile	lb/mile	lb/mile	
Heavy-Duty Truck ^a	3.98E-03	1.81E-02	5.40E-04	3.85E-04	7.84E-04	3.64E-05	3.76	3.64E-05	2.56E-04	
Number of Trips and Trip Length										
Vehicle	No. of One-Way Trips/Day ⁱ	One-Way Trip Length ^j (miles)								
Heavy-duty Truck	2	48								
Incremental Increase in Combustion Emissions from Onroad Mobile Vehicles										
Equation: Emission Factor (lb/mile) x No. of One-Way Trips/Day x 2 x Trip length (mile) = Mobile Emissions (lb/day)										
Vehicle	CO	NOx	PM10	PM2.5	VOC	SOx	CO2	CH4	NO2	
	lb/day	lb/day	lb/day	lb/day	lb/day	lb/day	lb/day	lb/day	lb/day	lb/day
Haul Truck	0.8	3.5	0.104	0.074	0.15	0.0070	721	0.0070	0.049	
Total Incremental Emissions										
Sources	CO	NOx	PM10	PM2.5	VOC	SOx	CO2			
Daily Emissions, lb	0.8	3.5	0.10	0.07	0.15	0.007	736			
Annual Emissions, ton (CO ₂ e metric ton)	0.0057	0.0261	0.0008	0.0006	0.0011	0.00005	5.0			
Daily Significance Threshold, lb/day	<i>548</i>	<i>100</i>	<i>82</i>	<i>82</i>	<i>75</i>	<i>137</i>	<i>548,000</i>			
Annual Significance Threshold, ton/yr^b	<i>100</i>	<i>25</i>	<i>15</i>	<i>15</i>	<i>25</i>	<i>25</i>	<i>10,000</i>			
Exceed Significance?	NO	NO	NO	NO	NO	NO	NO			

Notes:

a) Emission factors estimated using EMFAC2011 for the 2014 fleet year.

b) Lower of SCAQMD or MDAQMD significance thresholds used as surrogates

**Table A-1d
Demolition Emissions in Arizona**

Demolition Hauling MDAQMD		
Demolition Schedule	15	days ^a

	CO	NOx	PM10	PM2.5	VOC	SOx	CO2	CH4	NO2
	lb/mile	lb/mile	lb/mile	lb/mile	lb/mile	lb/mile	lb/mile	lb/mile	lb/mile
Heavy-Duty Truck ^a	3.98E-03	1.81E-02	5.40E-04	3.85E-04	7.84E-04	3.64E-05	3.76	3.64E-05	2.56E-04

Number of Trips and Trip Length		
Vehicle	No. of One-Way Trips/Dayⁱ	One-Way Trip Length^j (miles)
Heavy-duty Truck	2	1.5

Incremental Increase in Combustion Emissions from Onroad Mobile Vehicles									
Equation: Emission Factor (lb/mile) x No. of One-Way Trips/Day x 2 x Trip length (mile) = Mobile Emissions (lb/day)									
Vehicle	CO	NOx	PM10	PM2.5	VOC	SOx	CO2	CH4	NO2
	lb/day	lb/day	lb/day	lb/day	lb/day	lb/day	lb/day	lb/day	lb/day
Haul Truck	0.02	0.11	0.003	0.002	0.005	0.0002	23	0.0002	0.002

Total Incremental Emissions							
Sources	CO	NOx	PM10	PM2.5	VOC	SOx	CO2
Daily Emissions, lb	0.02	0.1	0.003	0.002	0.005	0.0002	23
Annual Emissions, ton (CO ₂ e metric ton)	0.0002	0.0008	0.000024	0.00002	0.00004	0.000002	0.2
Daily Significance Threshold, lb/day	<i>548</i>	<i>100</i>	<i>82</i>	<i>82</i>	<i>75</i>	<i>137</i>	<i>548,000</i>
Annual Significance Threshold, ton/yr^b	<i>100</i>	<i>25</i>	<i>15</i>	<i>15</i>	<i>25</i>	<i>25</i>	<i>10,000</i>
Exceed Significance?	NO	NO	NO	NO	NO	NO	NO

Notes:

a) Emission factors estimated using EMFAC2011 for the 2014 fleet year.

b) Lower of SCAQMD or MDAQMD significance thresholds used as surrogates

**Table A-1e
Demolition Emissions in Nevada**

Demolition Hauling MDAQMD									
Demolition Schedule	15	days ^a							
	CO	NOx	PM10	PM2.5	VOC	SOx	CO2	CH4	NO2
	lb/mile	lb/mile	lb/mile	lb/mile	lb/mile	lb/mile	lb/mile	lb/mile	lb/mile
Heavy-Duty Truck ^a	3.98E-03	1.81E-02	5.40E-04	3.85E-04	7.84E-04	3.64E-05	3.76	3.64E-05	2.56E-04
Number of Trips and Trip Length									
Vehicle	No. of One-Way Trips/Day ⁱ	One-Way Trip Length ^j (miles)							
Heavy-duty Truck	2	36							
Incremental Increase in Combustion Emissions from Onroad Mobile Vehicles									
Equation: Emission Factor (lb/mile) x No. of One-Way Trips/Day x 2 x Trip length (mile) = Mobile Emissions (lb/day)									
Vehicle	CO	NOx	PM10	PM2.5	VOC	SOx	CO2	CH4	NO2
	lb/day	lb/day	lb/day	lb/day	lb/day	lb/day	lb/day	lb/day	lb/day
Haul Truck	0.6	2.6	0.078	0.055	0.11	0.0052	541	0.0052	0.037
Total Incremental Emissions									
Sources	CO	NOx	PM10	PM2.5	VOC	SOx	CO2		
Daily Emissions, lb	0.6	2.6	0.08	0.06	0.11	0.005	552		
Annual Emissions, ton (CO ₂ e metric ton)	0.0043	0.0196	0.0006	0.0004	0.0008	0.00004	3.8		
Daily Significance Threshold, lb/day	<i>548</i>	<i>100</i>	<i>82</i>	<i>82</i>	<i>75</i>	<i>137</i>	<i>548,000</i>		
Annual Significance Threshold, ton/yr^b	<i>100</i>	<i>25</i>	<i>15</i>	<i>15</i>	<i>25</i>	<i>25</i>	<i>10,000</i>		
Exceed Significance?	NO	NO	NO	NO	NO	NO	NO		

Notes:

a) Emission factors estimated using EMFAC2011 for the 2014 fleet year.

b) Lower of SCAQMD or MDAQMD significance thresholds used as surrogates

**Table A-2
Fill Emissions**

Filling New Scrubber Foundation	320	cubic yards ^a
Fill Schedule -	8	days^a

Equipment Type^b	No. of Equipment	hr/day	Crew Size
Tractors/Loaders/Backhoes	2	7.0	6

Construction Equipment Emission Factors									
Equipment Type^c	CO	NOx	PM10	PM2.5	VOC	SOx	CO2	CH4	NO2
	lb/hr	lb/hr	lb/hr	lb/hr	lb/hr	lb/hr	lb/hr	lb/hr	lb/hr
Tractors/Loaders/Backhoes	0.374	0.498	0.034	0.031	0.073	0.001	67	0.007	0.021

Fugitive Dust Material Handling				
Aerodynamic Particle Size Multiplier^d	Mean Wind Speed^e	Moisture Content^f	Dirt Handled^g	Dirt Handled^h
	mph		cy	lb/day
0.35	2	7.9	40	100,000

Construction Vehicle (Mobile Source) Emission Factorsⁱ									
	CO	NOx	PM10	PM2.5	VOC	SOx	CO2	CH4	NO2
	lb/mile	lb/mile	lb/mile	lb/mile	lb/mile	lb/mile	lb/mile	lb/mile	lb/mile
Automobile	4.12E-03	3.41E-04	1.04E-04	4.41E-05	4.50E-04	8.22E-06	0.73	2.01E-05	4.83E-06
Heavy-Duty Truck	3.98E-03	1.81E-02	5.40E-04	3.85E-04	7.84E-04	3.64E-05	3.76	3.64E-05	2.56E-04

Number of Trips and Trip Length		
Vehicle	No. of One-Way Trips/Day	One-Way Trip Length (miles)
Automobile	6	20
Heavy-duty Truck ^j	1	40

Table A-2 (Continued)
Fill Emissions

Incremental Increase in Combustion Emissions from Construction Equipment									
Equation: Emission Factor (lb/hr) x No. of Equipment x Work Day (hr/day) = Construction Emissions (lb/day)									
Equipment Type	CO lb/day	NOx lb/day	PM10 lb/day	PM2.5 lb/day	VOC lb/day	SOx lb/day	CO2 lb/day	CH4 lb/day	NO2 lb/day
Tractors/Loaders/Backhoes	5.24	6.97	0.48	0.44	1.02	0.01	934	0.09	0.29
Total	5.2	7.0	0.48	0.44	1.0	0.01	934	0.09	0.29

Incremental Increase in Fugitive Dust Emissions from Construction Operations				
Equations:				
Material Handling ^k PM10 Emissions (lb/day) = (0.0032 x aerodynamic particle size multiplier x (wind speed (mph)/5) ^{1.3} /(moisture content/2) ^{1.4} x dirt handled (lb/day)/ 2,000 (lb/ton) (1 - control efficiency)				
Description	Control Efficiency %	Mitigated PM10 lb/day	Mitigated PM2.5 lb/day	
Material Handling	61	0.00010	0.0002	

Incremental Increase in Combustion Emissions from Onroad Mobile Vehicles									
Equation: Emission Factor (lb/mile) x No. of One-Way Trips/Day x 2 x Trip length (mile) = Mobile Emissions (lb/day)									
Vehicle	CO lb/day	NOx lb/day	PM10 lb/day	PM2.5 lb/day	VOC lb/day	SOx lb/day	CO2 lb/day	CH4 lb/day	NO2 lb/day
Automobile	0.96	4.35	0.13	0.09	0.19	0.0087	901	0.0087	0.0615
Haul Truck	0.32	1.45	0.04	0.03	0.06	0.0029	300	0.0029	0.0205
	1.27	5.79	0.17	0.12	0.25	0.012	1,202	0.012	0.082

Table A-2 (Concluded)
Fill Emissions

Total Incremental Emissions from Construction Activities							
Sources	CO	NOx	PM10	PM2.5	VOC	SOx	CO2
Emissions	lb/day	lb/day	lb/day	lb/day	lb/day	lb/day	metric ton/year
	6.5	13	0.65	0.56	1.3	0.023	8.2
Significance Threshold^m	550	100	150	55	75	150	
Exceed Significance?	NO	NO	NO	NO	NO	NO	

Notes:

- a) Assumed to be equivalent to amount of material removed during demolition.
- b) Construction equipment assumptions provided by Exide representatives and ENVIRON.
- c) Emission factors estimated using OFFROAD2011
- d) USEPA, AP-42, Jan 1995, Section 13.2.4 Aggregate Handling and Storage Piles, p 13.2.4-3 Aerodynamic particle size multiplier for < 10 µm
- e) Mean wind speed - maximum of daily average wind speeds reported in 1981 meteorological data.
- f) USEPA, Fugitive Dust Background Document and Technical Information Document for Best Available Control Measures, equation 2-13, p 2-28
- g) Assuming 40 cubic yards of dirt handled (320 ft³)/8 days)
- h) Dirt handled, lb/day = (320 yd³ x 2,500 lb/yd³)
- i) Emission factors estimated using EMFAC2011 for the 2014 fleet year.
- j) Based on 40 cubic yd truck capacity [(320 cy x truck/40 cy) = 1 one-way truck trips/day].
- k) USEPA, Fugitive Dust Background Document and Technical Information Document for Best Available Control Measures, Sept 1992, EPA-450/2-92-004, Equation 2-12
- l) Includes watering at least three times a day per Rule 403 (61% control efficiency)
- m) SCAQMD CEQA significance thresholds

**Table A-3
Paving Emissions**

Paving of Foundation		
Construction Schedule	8	days^a

Equipment Type^a	No. of Equipment	hr/day	Crew Size
Cement and Mortar Mixers	1	5.0	6

Construction Equipment Combustion Emission Factors									
	CO	NOx	PM10	PM2.5	VOC	SOx	CO2	CH4	NO2
Equipment Type^b	lb/hr	lb/hr	lb/hr		lb/hr	lb/hr	lb/hr	lb/hr	lb/hr
Cement and Mortar Mixers	0.042	0.055	0.002	0.002	0.009	0.000	7	0.001	0.000

Construction Vehicle (Mobile Source) Emission Factors^c									
	CO	NOx	PM10	PM2.5	VOC	SOx	CO2	CH4	NO2
	lb/mile	lb/mile	lb/mile	lb/mile	lb/mile	lb/mile	lb/mile	lb/mile	lb/mile
Automobile	4.12E-03	3.41E-04	1.04E-04	4.41E-05	4.50E-04	8.22E-06	7.28E-01	2.01E-05	4.83E-06
Heavy-Duty Truck	3.98E-03	1.81E-02	5.40E-04	3.85E-04	7.84E-04	3.64E-05	3.76E+00	3.64E-05	2.56E-04

Number of Trips and Trip Length		
Vehicle	No. of One-Way Trips/Day	One-Way Trip Length (miles)
Worker	6	20
Delivery Truck ^d	3	40

Table A-3 (Concluded)
Paving Emissions

Incremental Increase in Combustion Emissions from Construction Equipment									
Equation: Emission Factor (lb/hr) x No. of Equipment x Work Day (hr/day) = Construction Emissions (lb/day)									
Equipment Type	CO	NOx	PM10	PM2.5	VOC	SOx	CO2	CH4	NO2
	lb/day	lb/day	lb/day	lb/day	lb/day	lb/day	lb/day	lb/day	lb/day
Cement and Mortar Mixers	0.21	0.28	0.01	0.01	0.04	0.001	36	0.004	0.000
Total	0.21	0.28	0.01	0.01	0.04	0.001	36	0.004	0.000

Incremental Increase in Combustion Emissions from Onroad Mobile Vehicles									
Equation: Emission Factor (lb/mile) x No. of One-Way Trips/Day x 2 x Trip length (mile) = Mobile Emissions (lb/day)									
Vehicle	CO	NOx	PM10	PM2.5	VOC	SOx	CO2	CH4	NO2
	lb/day	lb/day	lb/day	lb/day	lb/day	lb/day	lb/day	lb/day	lb/day
Automobile	0.99	0.08	0.025	0.011	0.108	0.002	175	0.005	0.0012
Delivery Truck	0.96	4.35	0.130	0.092	0.188	0.009	901	0.009	0.0615
Total	1.94	4.43	0.155	0.103	0.296	0.011	1,076	0.014	0.0627

Total Incremental Emissions from Construction Activities							
Sources	CO	NOx	PM10	PM2.5	VOC	SOx	CO2eq
	lb/day	lb/day	lb/day	lb/day	lb/day	lb/day	metric ton/year
Emissions	2.2	4.7	0.17	0.11	0.34	0.01	4.1
Significance Threshold^c	550	100	150	55	75	150	
Exceed Significance?	NO	NO	NO	NO	NO	NO	

Notes:

- a) Construction equipment assumptions from Exide representatives and ENVIRON.
b) Emission factors estimated using OFFROAD2011
c) Emission factors estimated using EMFAC2011 for the 2014 fleet year.
d) Assumed three deliver truck trips per day.
e) SCAQMD CEQA significance thresholds

**Table A-4
Structure Building Emissions**

Construction of RRP Equipment	
Construction Schedule	90 days

Equipment Type^a	No. of Equipment	hr/day	Crew Size
Cranes	2	7.0	60
Forklifts	5	7.0	
Tractors/Loaders/Backhoes	2	7.0	

Construction Equipment Combustion Emission Factors									
Equipment Type^b	CO	NOx	PM10	PM2.5	VOC	SOx	CO2	CH4	NO2
	lb/hr	lb/hr	lb/hr		lb/hr	lb/hr	lb/hr	lb/hr	lb/hr
Cranes	0.431	1.028	0.044	0.041	0.120	0.001	121	0.011	0.043
Forklifts	0.221	0.355	0.018	0.016	0.050	0.001	54	0.004	0.015
Tractors/Loaders/Backhoes	0.374	0.498	0.034	0.031	0.073	0.001	67	0.007	0.021

Construction Vehicle (Mobile Source) Emission Factors^c									
	CO	NOx	PM10	PM2.5	VOC	SOx	CO2	CH4	NO2
	lb/mile	lb/mile	lb/mile	lb/mile	lb/mile	lb/mile	lb/mile	lb/mile	lb/mile
Automobile	4.12E-03	3.41E-04	1.04E-04	4.41E-05	4.50E-04	8.22E-06	7.28E-01	2.01E-05	4.83E-06
Heavy-Duty Truck	3.98E-03	1.81E-02	5.40E-04	3.85E-04	7.84E-04	3.64E-05	3.76E+00	3.64E-05	2.56E-04

Number of Trips and Trip Length		
Vehicle	No. of One-Way Trips/Day	One-Way Trip Length (miles)
Worker	60	20
Heavy-duty Truck ^d	3	40

Table A-4 (Concluded)
Structure Building Emissions

Incremental Increase in Combustion Emissions from Construction Equipment									
Equation: Emission Factor (lb/hr) x No. of Equipment x Work Day (hr/day) = Construction Emissions (lb/day)									
Equipment Type	CO	NOx	PM10	PM2.5	VOC	SOx	CO2	CH4	NO2
	lb/day	lb/day	lb/day	lb/day	lb/day	lb/day	lb/day	lb/day	lb/day
Cranes	6.0	14.4	0.62	0.57	1.7	0.02	1,693	0.15	0.60
Forklifts	7.7	12.4	0.62	0.57	1.74	0.02	1,903	0.16	0.52
Tractors/Loaders/Backhoes	5.2	7.0	0.48	0.44	1.02	0.01	934	0.09	0.29
Total	19.0	33.8	1.7	1.6	4.4	0.05	4,530	0.40	1.4

Incremental Increase in Combustion Emissions from Onroad Mobile Vehicles									
Equation: Emission Factor (lb/mile) x No. of One-Way Trips/Day x 2 x Trip length (mile) = Mobile Emissions (lb/day)									
Vehicle	CO	NOx	PM10	PM2.5	VOC	SOx	CO2	CH4	NO2
	lb/day	lb/day	lb/day	lb/day	lb/day	lb/day	lb/day	lb/day	lb/day
Automobile	9.56	43.5	1.30	0.923	1.88	0.087	9,013	0.087	0.62
Delivery Truck	0.96	4.3	0.13	0.092	0.19	0.009	901	0.009	0.06
Total	10.5	47.8	1.43	1.02	2.07	0.096	9,914	0.096	0.68

Total Incremental Emissions from Construction Activities							
Sources	CO	NOx	PM10	PM2.5	VOC	SOx	CO2eq
	lb/day	lb/day	lb/day	lb/day	lb/day	lb/day	metric ton/year
Emissions	30	82	3.1	2.6	6.5	0.1	616
Significance Threshold^c	550	100	150	55	75	150	
Exceed Significance?	NO	NO	NO	NO	NO	NO	

Notes:

- Estimated construction equipment assumed to operate one eight-hour shift per day.
- Emission factors estimated using OFFROAD2011
- Emission factors estimated using EMFAC2011 for the 2014 fleet year.
- Assumed three deliver truck trips per day.
- SCAQMD CEQA significance thresholds

**Table A-5a
Operational Emissions in SCAQMD**

Vehicle (Mobile Source) Emission Factors									
	CO	NOx	PM10	PM2.5	VOC	SOx	CO2	CH4	NO2
	lb/mile	lb/mile	lb/mile	lb/mile	lb/mile	lb/mile	lb/mile	lb/mile	lb/mile
Automobile	4.12E-03	3.41E-04	1.04E-04	4.41E-05	4.50E-04	8.22E-06	0.73	2.01E-05	4.83E-06
Heavy-Duty Truck ^a	3.98E-03	1.81E-02	5.40E-04	3.85E-04	7.84E-04	3.64E-05	3.76	3.64E-05	2.56E-04

Number of Trips and Trip Length		
Vehicle	No. of One-Way Trips/Dayⁱ	One-Way Trip Length^j (miles)
Worker	6	20
Heavy-duty Haul Truck	5	193
Heavy-duty Delivery Truck	5	40

Incremental Increase in Combustion Emissions from Onroad Mobile Vehicles									
Equation: Emission Factor (lb/mile) x No. of One-Way Trips/Day x 2 x Trip length (mile) = Mobile Emissions (lb/day)									
Vehicle	CO	NOx	PM10	PM2.5	VOC	SOx	CO2	CH4	NO2
	lb/day	lb/day	lb/day	lb/day	lb/day	lb/day	lb/day	lb/day	lb/day
Automobile	0.99	0.082	0.025	0.011	0.11	0.002	175	0.005	4.83E-06
Haul Truck	7.7	35	1.0	0.74	1.5	0.070	7,248	0.070	0.495
Delivery Truck	1.6	7.2	0.22	0.15	0.31	0.015	1,502	0.015	0.103

Total Incremental Emissions from Construction Activities							
Sources	CO	NOx	PM10	PM2.5	VOC	SOx	CO2e^b
Emissions	lb/day	lb/day	lb/day	lb/day	lb/day	lb/day	metric ton/year
	10	42	1.3	0.9	1.9	0.09	9.5
Significance Threshold^c	550	55	150	55	75	150	10,000
Exceed Significance?	NO	NO	NO	NO	NO	NO	NO

Notes:

a) Emission factors estimated using EMFAC2011 for the 2014 fleet year.

b) Annual CO2e value includes thirteen additional truck trips annually (ten trips related to additional filter media replacement, one trip related to additional spent metal disposal and two trip related to replacement of thermal media) and three gasoline fuel vehicle source test trips.

c) SCAQMD significance thresholds.

**Table A-5b
Operational Emissions in MDAQMD**

Construction Vehicle (Mobile Source) Emission Factors									
	CO	NOx	PM10	PM2.5	VOC	SOx	CO2	CH4	NO2
	lb/mile	lb/mile	lb/mile	lb/mile	lb/mile	lb/mile	lb/mile	lb/mile	lb/mile
Heavy-Duty Truck ^a	3.98E-03	1.81E-02	5.40E-04	3.85E-04	7.84E-04	3.64E-05	3.76	3.64E-05	2.56E-04

Number of Trips and Trip Length		
Vehicle	No. of One-Way Trips/Dayⁱ	One-Way Trip Length^j (miles)
Heavy-duty Truck	5	157

Incremental Increase in Combustion Emissions from Onroad Mobile Vehicles									
Equation: Emission Factor (lb/mile) x No. of One-Way Trips/Day x 2 x Trip length (mile) = Mobile Emissions (lb/day)									
Vehicle	CO	NOx	PM10	PM2.5	VOC	SOx	CO2	CH4	NO2
	lb/day	lb/day	lb/day	lb/day	lb/day	lb/day	lb/day	lb/day	lb/day
Haul Truck	6.3	28.4	0.85	0.60	1.23	0.057	5,896	0.0572	0.403

Total Incremental Emissions							
Sources	CO	NOx	PM10	PM2.5	VOC	SOx	CO2^b
Daily Emissions, lb	6.3	28.4	0.85	0.60	1.23	0.057	6,022
Annual Emissions, ton/ (CO2e metric ton)	0.0031	0.0142	0.00042	0.00030	0.00062	0.000029	7.8
Daily Significance Threshold, lb/day	548	137	82	82	137	137	548,000
Annual Significance Threshold, ton/yr^c	100	25	15	15	25	25	100,000
Exceed Significance?	NO	NO	NO	NO	NO	NO	NO

Notes:

a) Emission factors estimated using EMFAC2011 for the 2014 fleet year.

b) Annual CO2e value includes thirteen additional truck trips annually (ten trips related to additional filter media replacement, one trip related to additional spent metal disposal and two trip related to replacement of thermal media) and three gasoline fuel vehicle source test trips.

c) MDAQMD significance thresholds.

**Table A-5c
Operational Emissions in GBUAPCD**

Construction Vehicle (Mobile Source) Emission Factors									
	CO	NOx	PM10	PM2.5	VOC	SOx	CO2	CH4	NO2
	lb/mile	lb/mile	lb/mile	lb/mile	lb/mile	lb/mile	lb/mile	lb/mile	lb/mile
Heavy-Duty Truck ^a	3.98E-03	1.81E-02	5.40E-04	3.85E-04	7.84E-04	3.64E-05	3.76	3.64E-05	2.56E-04

Number of Trips and Trip Length		
Vehicle	No. of One-Way Trips/Dayⁱ	One-Way Trip Length^j (miles)
Heavy-duty Truck	5	48

Incremental Increase in Combustion Emissions from Onroad Mobile Vehicles									
Equation: Emission Factor (lb/mile) x No. of One-Way Trips/Day x 2 x Trip length (mile) = Mobile Emissions (lb/day)									
Vehicle	CO	NOx	PM10	PM2.5	VOC	SOx	CO2	CH4	NO2
	lb/day	lb/day	lb/day	lb/day	lb/day	lb/day	lb/day	lb/day	lb/day
Haul Truck	1.9	8.7	0.26	0.18	0.38	0.017	1,803	1.9	8.7

Total Incremental Emissions							
Sources	CO	NOx	PM10	PM2.5	VOC	SOx	CO2^b
Daily Emissions, lb	1.9	8.7	0.26	0.18	0.38	0.017	1,841
Annual Emissions, ton (CO2e metric ton)	0.0010	0.0043	0.00013	0.00009	0.00019	0.000009	2.2
Daily Significance Threshold, lb/day							
Annual Significance Threshold, ton/yr^c							
Exceed Significance?	NO	NO	NO	NO	NO	NO	NO

Notes:

a) Emission factors estimated using EMFAC2011 for the 2014 fleet year.

b) Annual CO2e value includes thirteen additional truck trips annually (ten trips related to additional filter media replacement, one trip related to additional spent metal disposal and two trip related to replacement of thermal media) and three gasoline fuel vehicle source test trips.

c) Lower of SCAQMD or MDAQMD significance thresholds used as surrogates.

**Table A-5d
Operational Emissions in Arizona**

Construction Vehicle (Mobile Source) Emission Factors									
	CO	NOx	PM10	PM2.5	VOC	SOx	CO2	CH4	NO2
	lb/mile	lb/mile	lb/mile	lb/mile	lb/mile	lb/mile	lb/mile	lb/mile	lb/mile
Heavy-Duty Truck ^a	3.98E-03	1.81E-02	5.40E-04	3.85E-04	7.84E-04	3.64E-05	3.76	3.64E-05	2.56E-04

Number of Trips and Trip Length		
Vehicle	No. of One-Way Trips/Dayⁱ	One-Way Trip Length^j (miles)
Heavy-duty Truck	5	1.5

Incremental Increase in Combustion Emissions from Onroad Mobile Vehicles									
Equation: Emission Factor (lb/mile) x No. of One-Way Trips/Day x 2 x Trip length (mile) = Mobile Emissions (lb/day)									
Vehicle	CO	NOx	PM10	PM2.5	VOC	SOx	CO2	CH4	NO2
	lb/day	lb/day	lb/day	lb/day	lb/day	lb/day	lb/day	lb/day	lb/day
Haul Truck	0.1	0.3	0.01	0.01	0.01	0.001	56	0.0005	0.004

Total Incremental Emissions							
Sources	CO	NOx	PM10	PM2.5	VOC	SOx	CO2^b
Daily Emissions, lb	0.1	0.3	0.01	0.01	0.01	0.001	58
Annual Emissions, ton (CO2e metric ton)	0.0000	0.0001	0.00000	0.00000	0.00001	0.000000	0.1
Daily Significance Threshold, lb/day							
Annual Significance Threshold, ton/yr^c							
Exceed Significance?	NO	NO	NO	NO	NO	NO	NO

Notes:

a) Emission factors estimated using EMFAC2011 for the 2014 fleet year.

b) Annual CO2e value includes thirteen additional truck trips annually (ten trips related to additional filter media replacement, one trip related to additional spent metal disposal and two trip related to replacement of thermal media) and three gasoline fuel vehicle source test trips.

c) Lower of SCAQMD or MDAQMD significance thresholds used as surrogates.

**Table A-5e
Operational Emissions in Nevada**

Construction Vehicle (Mobile Source) Emission Factors									
	CO	NOx	PM10	PM2.5	VOC	SOx	CO2	CH4	NO2
	lb/mile	lb/mile	lb/mile	lb/mile	lb/mile	lb/mile	lb/mile	lb/mile	lb/mile
Heavy-Duty Truck ^a	3.98E-03	1.81E-02	5.40E-04	3.85E-04	7.84E-04	3.64E-05	3.76	3.64E-05	2.56E-04

Number of Trips and Trip Length		
Vehicle	No. of One-Way Trips/Dayⁱ	One-Way Trip Length^j (miles)
Heavy-duty Truck	5	36

Incremental Increase in Combustion Emissions from Onroad Mobile Vehicles									
Equation: Emission Factor (lb/mile) x No. of One-Way Trips/Day x 2 x Trip length (mile) = Mobile Emissions (lb/day)									
Vehicle	CO	NOx	PM10	PM2.5	VOC	SOx	CO2	CH4	NO2
	lb/day	lb/day	lb/day	lb/day	lb/day	lb/day	lb/day	lb/day	lb/day
Haul Truck	1.4	6.5	0.19	0.14	0.28	0.013	1,352	0.013	0.09

Total Incremental Emissions							
Sources	CO	NOx	PM10	PM2.5	VOC	SOx	CO2^b
Daily Emissions, lb	1.4	6.5	0.19	0.14	0.28	0.013	1,381
Annual Emissions, ton (CO2e metric ton)	0.0007	0.0033	0.00010	0.00007	0.00014	0.000007	1.6
Daily Significance Threshold, lb/day							
Annual Significance Threshold, ton/yr^c							
Exceed Significance?	NO	NO	NO	NO	NO	NO	NO

Notes:

a) Emission factors estimated using EMFAC2011 for the 2014 fleet year.

b) Annual CO2e value includes thirteen additional truck trips annually (ten trips related to additional filter media replacement, one trip related to additional spent metal disposal and two trip related to replacement of thermal media) and three gasoline fuel vehicle source test trips.

c) Lower of SCAQMD or MDAQMD significance thresholds used as surrogates.

**Table A-6
2014 Final EA for Rule 1420.1 Regenerative Thermal Oxidizer Operational Emissions**

Annual Emission Reporting Default Emission Factors for External Combustion Equipment

Fuel Type (fuel unit)	VOC, lb/mmscf	Rule 1147 NOx, lb/mmbtu	SOx, lb/mmscf	CO, lb/mmscf	PM, lb/mmscf	CO2, lb/mmscf	N2O, lb/mmscf	CH4, lb/mmscf
Natural Gas/ Other Equipment	7	0.073	0.6	35	7.5	120,000	0.64	2.3

Annual Emission Reporting (AER) defaulting emission factors from B1 external combustion equipment for all criteria pollutants exempt NOx. Exide is a RECLAIM facility so BACT would be required for the thermal oxidizer under Rule 2005; therefore, Rule 1147 NOx emissions limit was used. CO2, N2O and CH4 emission factors from AP-42 Table 1.4-2, July 1998

Thermal Oxidizer Criteria Pollutant Emissions

Natural Gas Rating, mmbtu/hr	Conversion, btu/scf	Natural Gas Usage, mmscf/hr	Op Time, hr/day	ROG, lb/day	NOx, lb/day	SOx, lb/day	CO, lb/day	PM, lb/day
1.58	1,050	0.00150	24	0.3	2.8	0.02	1.3	0.3

Natural gas rating based on engineering estimate.

Thermal Oxidizer Greenhouse Gas Emissions

Natural Gas Usage, mmscf/yr	CO2, metric ton/year	N2O, metric ton/year	CH4, metric ton/year	CO2e, metric ton/year
13.1	716	0.00	0.01	717

Table A-6 (Concluded)
2014 Final EA for Rule 1420.1 Regenerative Thermal Oxidizer Operational Emissions

Thermal Oxidizer Toxic Emissions

TAC Code	Pollutant	Cas No.	<10 Mmbtu/Hr, lb/mmscf	TAC, lb/yr	TAC ton/yr	TAC, lb/hr	Screen Level at 100 meters, lb/yr	Screen Level at 100 meters, lb/hr
2	Benzene	71432	0.008	1.05E-01	5.26E-05	1.20E-05	8.92E+00	3.96E+00
12	Formaldehyde	50000	0.017	2.23E-01	1.12E-04	2.56E-05	4.25E+01	1.47E-01
19	PAHs	1151	0.0004	5.26E-03	2.63E-06	6.02E-07	7.69E-03	

Screening levels from the Permit Package L of the Risk Assessment Procedures for Rules 1401 and 212 Version 7.0, December 2012

**Table A-7a
Proposed Project Rotary Dryer Regenerative Thermal Oxidizer Operational Emissions**

EMISSIONS FROM NATURAL GAS COMBUSTION

A/N	559499	HOURS/DAY:	24.00		
		DAYS/WEEK:	7.00	RTO For Rotary Dryer	
	OPERATING SCHED:	WEEKS/YEAR:	52.00		
	(DAILY AND ANNUAL)	DAYS/YEAR:	365.00		
APCS EFFICIENCY					
ROG	NOx	SOx	CO	PM10	
-----	-----	-----	-----	-----	
0.00	0.00	0.00	0.00	0.00	
				Max Firing Rate:	2.50000 (MMbtu/hr)
				Usage factor:	1.00000 (max PTE)
				Ave Firing Rate:	2.50000 (MMbtu/hr)
FIRING RATE	EMISSION	FACTOR	R1 EMIS.	R2 EMIS.	
(MMbtu/hr)	TYPE	(LB/MMbtu)	(LBS/HR)	(LBS/HR)	
-----	-----	-----	-----	-----	
2.50000	ROG	0.0067	0.01675	0.01675	
2.50000	NOx	0.0365	0.09117	0.09117	
2.50000	SOx	0.0008	0.00198	0.00198	
2.50000	CO	0.2960	0.74011	0.74011	
2.50000	PM10	0.0071	0.01786	0.01786	

EMISSIONS SUMMARY

	ROG	NOx	SOx	CO	PM10
R1, lb/hr	0.0168	0.0912	0.0020	0.7401	0.0179
R1, lb/day	0.4020	2.1881	0.0474	17.7627	0.4286
R2, lb/hr	0.0168	0.0912	0.0020	0.7401	0.0179
R2, lb/day	0.4020	2.1881	0.0474	17.7627	0.4286
R2, lb/day	0.4020	2.1881	0.0474	17.7627	0.4286
(30 day average)					
R2, lb/year	146.7300	798.6434	17.3120	6483.3763	156.4317
R2, ton/yr	0.0734	0.3993	0.0087	3.2417	0.0782

Note: NOx and CO emission factors based on 30 and 400 PPMv, respectively, @ 3% O2, per manufacturer's data (as stated by the applicant in 5-6-2014 information letter)

Table A-7b
Proposed Project Rotary Dryer Regenerative Thermal Oxidizer Operational Emissions

$$\text{Lbs/MMBtu} = \text{PPM}_v * \text{MW} * (20.9/(20.9 - b)) * 2.263\text{E-}05$$

Compound	b = %O2	PPM _v	MW	20.9/(20.9-b)	Calc Factor	Lbs/MMBtu
NO2	3	30	46.0055	1.1676	2.263E-05	0.036
CO	3	400	28.0104	1.1676	2.263E-05	0.296

Thermal Oxidizer Toxic Emissions

TAC Code	Pollutant	Cas No.	<10 Mmbtu/Hr, lb/mmcf	TAC, lb/yr	TAC ton/yr	TAC, lb/hr
2	Benzene	71432	0.008	1.66E-01	8.32E-05	1.90E-05
12	Formaldehyde	50000	0.017	3.54E-01	1.77E-04	4.05E-05
19	PAHs	1151	0.0004	2.08E-03	1.04E-06	2.38E-07
19	Naphthalene	91203	0.0003	6.24E-03	3.12E-06	7.14E-07
29	Acetaldehyde	75070	0.0043	8.94E-02	4.47E-05	1.02E-05
30	Acrolein	107028	0.0027	5.62E-02	2.81E-05	6.43E-06
32	Ammonia*	7664417	18	3.74E+02	1.87E-01	4.29E-02
40	Ethyl benzene	100414	0.0095	1.98E-01	9.88E-05	2.26E-05
44	Hexane	110543	0.0063	1.31E-01	6.55E-05	1.50E-05
68	Toluene	108883	0.0366	7.61E-01	3.81E-04	8.71E-05
70	Xylene	1330207	0.0272	5.66E-01	2.83E-04	6.48E-05

Table A-8a
Proposed Project Cupola Furnace Thimble Hood RTO Operational Emissions

EMISSIONS FROM NATURAL GAS COMBUSTION

A/N **562498** **HOURS/DAY: 24.00**
 DAYS/WEEK: 7.00
OPERATING SCHED: **WEEKS/YEAR: 52.00**
(DAILY AND ANNUAL) **DAYS/YEAR: 365.00**

RTO For Cupola Furnace Thimble Hoods

**APCS
EFFICIENCY**

Max Firing Rate: 4.60000 (MMbtu/hr)
Usage factor: 1.00000 (max PTE)
Ave Firing Rate: 4.60000 (MMbtu/hr)

ROG	NOx	SOx	CO	PM10
-----	-----	-----	-----	-----
0.00	0.00	0.00	0.00	0.00

FIRING RATE (MMbtu/hr)	EMISSION TYPE	FACTOR (LB/MMbtu)	R1 EMIS. (LBS/HR)	R2 EMIS. (LBS/HR)
-----	-----	-----	-----	-----
4.60000	ROG	0.0067	0.03082	0.03082
4.60000	NOx	0.0365	0.16775	0.16775
4.60000	SOx	0.0008	0.00364	0.00364
4.60000	CO	0.2960	1.36181	1.36181
4.60000	PM10	0.0071	0.03286	0.03286

EMISSIONS SUMMARY

	ROG	NOx	SOx	CO	PM10
R1, lb/hr	0.0308	0.1678	0.0036	1.3618	0.0329
R1, lb/day	0.7397	4.0260	0.0873	32.6833	0.7886
R2, lb/hr	0.0308	0.1678	0.0036	1.3618	0.0329
R2, lb/day	0.7397	4.0260	0.0873	32.6833	0.7886
R2, lb/day (30 day average)	0.7397	4.0260	0.0873	32.6833	0.7886
R2, lb/year	269.9832	1469.5039	31.8540	11929.4123	287.8343
R2, ton/yr	0.1350	0.7348	0.0159	5.9647	0.1439

Note: NOx and CO emission factors based on 30 and 400 PPMv, respectively, @ 3% O2, per manufacturer's data (as stated by the applicant in 5-6-2014 information letter)

Table A-8b
Proposed Project Cupola Furnace Thimble RTO Operational Emissions (Continued)

$$\text{Lbs/MMBtu} = \text{PPMv} * \text{MW} * (20.9/(20.9 - b)) * 2.263\text{E-}05$$

Compound	b = %O2	PPMv	MW	20.9/(20.9-b)	Calc Factor	Lbs/MMBtu
NO2	3	30	46.0055	1.1676	2.263E-05	0.036
CO	3	400	28.0104	1.1676	2.263E-05	0.296

RTO Toxic Emissions

TAC Code	Pollutant	Cas No.	<10 Mmbtu/Hr, lb/mmscf	TAC, lb/yr	TAC ton/yr	TAC, lb/hr
2	Benzene	71432	3.06E-01	1.53E-04	3.50E-05	3.06E-01
12	Formaldehyde	50000	6.51E-01	3.25E-04	7.45E-05	6.51E-01
19	PAHs	1151	3.83E-03	1.91E-06	4.38E-07	3.83E-03
19	Naphthalene	91203	1.15E-02	5.74E-06	1.31E-06	1.15E-02
29	Acetaldehyde	75070	1.65E-01	8.23E-05	1.88E-05	1.65E-01
30	Acrolein	107028	1.03E-01	5.17E-05	1.18E-05	1.03E-01
32	Ammonia*	7664417	6.89E+02	3.44E-01	7.89E-02	6.89E+02
40	Ethyl benzene	100414	3.64E-01	1.82E-04	4.16E-05	3.64E-01
44	Hexane	110543	2.41E-01	1.21E-04	2.76E-05	2.41E-01
68	Toluene	108883	1.40E+00	7.00E-04	1.60E-04	1.40E+00
70	Xylene	1330207	1.04E+00	5.20E-04	1.19E-04	1.04E+00

Table A-9
Proposed Project Health Risk Screening from Natural Gas Combustion

TAC Code	Pollutant	Cas No.	TAC, lb/yr	TAC, lb/hr	Screen Level at 100 meters, lb/yr	Screen Level at 100 meters, lb/hr	(TAC, lb/yr)/ (Screen Level, lb/yr)	(TAC, lb/hr)/ (Screen Level, lb/hr)
2	Benzene	71432	4.73E-01	5.41E-05	8.92E+00	3.96E+00	5.30E-02	1.37E-05
12	Formaldehyde	50000	1.00E+00	1.15E-04	4.25E+01	1.47E-01	2.36E-02	7.82E-04
19	PAHs*	1151	5.91E-03	6.76E-07	7.69E-03		7.68E-01	
19	Naphthalene	91203	1.77E-02	2.03E-06	7.44E+00		2.38E-03	
29	Acetaldehyde	75070	2.54E-01	2.91E-05	8.92E+01		2.85E-03	
30	Acrolein	107028	1.59E-01	1.83E-05	1.50E+01		1.06E-02	
32	Ammonia*	7664417	1.06E+03	1.22E-01	5.17E+04	8.57	2.06E-02	1.42E-02
40	Ethyl benzene	100414	5.61E-01	6.42E-05	5.17E+05		1.09E-06	
44	Hexane	110543	3.72E-01	4.26E-05	1.81E+06		2.06E-07	
68	Toluene	108883	2.16E+00	2.47E-04	7.75E+04	9.91E+01	2.79E-05	2.50E-06
70	Xylene	1330207	1.61E+00	1.84E-04	1.81E+05	5.89E+01	8.88E-06	3.12E-06
							8.81E-01	1.50E-02

Screening levels from Table 1A of the Permit Package L of the Risk Assessment Procedures for Rules 1401 and 212 Version 7.0, December 2012

Risk Assessment Procedures for Rules 1401 and 212 Version 7.0, December 2012 multiple pollutant screening procedure states that if the sum of the emissions divided by the Table 1A screen level is less than one then additional analysis is not required.

**Table A-10
GHG Operational Emissions**

Fuel Type (fuel unit)	CO₂, lb/mmscf	N₂O, lb/mmscf	CH₄, lb/mmscf
Natural Gas/ Other Equipment	120,000	2.2	2.3

CO₂, N₂O and CH₄ emission factors from AP-42 Table 1.4-2, July 1998

Proposed Project

Description	Natural Gas Usage, mmbtu/hr	Conversion, btu/scf	Natural Gas Usage, mmscf/hr	Op Time, hr/year	CO₂, metric ton/year	N₂O, metric ton/year	CH₄, metric ton/year	CO₂e, metric ton/year
Rotary Dryer RTO	2.5	1,020	0.0025	8,736	1,165	0.021	0.022	1,173
Blast Furnace Thimble RTO	4.6	1,020	0.0045	8,736	2,144	0.039	0.041	2,158
Totals					3,310	0.061	0.063	3,330

Usage, mmscf/hr = usage, mmBtu/hr x scf/1,050 mmbtu

Emissions, metric ton/yr = usage, mmscf/hr x op time, hr/yr x emission factor, lb/mmscf x metric ton/2,204.6

**Table A-11
Vehicle Hauling Operational Emissions**

CO, g/hr-veh	NO_x, g/hr-veh	PM₁₀, g/hr-veh	PM_{2.5}, g/hr-veh	ROG, g/hr-veh	SO_x, g/hr-veh
67.41757	73.66038971	7.16075	6.58789	38.69741	1.9709892

ARB, 2013, http://www.arb.ca.gov/msei/emfac2011_idling_emission_rates.xlsx.

Idling Time, min/trip	CO, lb/day	NO_x, lb/day	PM, lb/day	ROG, lb/day	SO_x, lb/day
15	0.037	0.0401	0.0039	0.00361	0.0211

**Table A-12
Construction Equipment Fuel Use**

Equipment Type	No. of Equipment	Op Time, hr/day	Fuel Economy, gal/hr	Fuel Used, gal/day
Aerial Lifts	2	7.0	1.2	16.5
Tractors/Loaders/Backhoes	3	7.0	1.9	39.9
				56.4

Demolition

Equipment Type	No. of Equipment	Op Time, hr/day	Fuel Economy, gal/hr	Fuel Used, gal/day
Concrete/Industrial Saws	2	7.0		
Cranes	1	3.0	3.5	10.6
Tractors/Loaders/Backhoes	3	7.0	1.9	39.9
				50.5

Fill

Equipment Type	No. of Equipment	Op Time, hr/day	Fuel Economy, gal/hr	Fuel Used, gal/day
Tractors/Loaders/Backhoes	2	7.0	1.9	26.6
				26.6

Paving

Equipment Type	No. of Equipment	Op Time, hr/day	Fuel Economy, gal/hr	Fuel Used, gal/day
Cement and Mortar Mixers	1	5.0	0	0

Structure Construction

Equipment Type	No. of Equipment	Op Time, hr/day	Fuel Economy, gal/hr	Fuel Used, gal/day
Cranes	2	7.0	3.52	49.3
Forklifts	5	7.0	0.96	33.6
Tractors/Loaders/Backhoes	2	7.0	1.9	26.6
				109.5

**Table A-13
Vehicle Fuel Use**

Vehicle	No. of One-Way, Trips/Day	One-Way Trip Length, miles	Fuel Economy, mpg	Fuel Used, gal/day
Automobile	8	20	10	32
Heavy-duty Truck	2	40	40	4

Demolition

Vehicle	No. of One-Way, Trips/Day	One-Way Trip Length, miles	Fuel Economy, mpg	Fuel Used, gal/day
Automobile	6	20	10	24
Heavy-duty Truck	2	305	40	50

Fill

Vehicle	No. of One-Way, Trips/Day	One-Way Trip Length, miles	Fuel Economy, mpg	Fuel Used, gal/day
Automobile	6	20	10	24
Heavy-duty Truck	2	40	40	4

Paving

Vehicle	No. of One-Way, Trips/Day	One-Way Trip Length, miles	Fuel Economy, mpg	Fuel Used, gal/day
Automobile	6	20	10	24
Heavy-duty Truck	3	40	40	6

Structure Building

Vehicle	No. of One-Way, Trips/Day	One-Way Trip Length, miles	Fuel Economy, mpg	Fuel Used, gal/day
Automobile	60	20	10	240
Heavy-duty Truck	3	40	40	6

Operational

Vehicle	No. of One-Way, Trips/Day	One-Way Trip Length, miles	Fuel Economy, mpg	Fuel Used, gal/day
Automobile	6	20	10	24
Heavy-duty Haul Truck	5	305	40	76
Heavy-duty Delivery Truck	5	40	40	10

Table A-14
Estimate of Spent Filter Volume

Description	Number of Filters	Filter Volume, cubic feet	Filter Volume, cubic yard	Total Volume, cubic yard
Dust collector (pre-filter)	50	0.7	0.02	1.2
Dust collector (HEPA filter)	50	4.0	0.15	7.4
Baghouse	494	1.6	0.06	30
Dust collector	64	44	1.6	104
Total				143

APPENDIX B

**PROPOSED REVISED FINAL RISK REDUCTION PLAN
RULE 1402**



**Revised Final Risk Reduction
Plan
Rule 1402**

Prepared for:
**South Coast Air Quality Management District
Diamond Bar, California**

On behalf of:
**Exide Technologies, Inc.
Vernon, California**

Prepared by:
**ENVIRON International Corporation
Los Angeles, California**

Date:
Revised August 2014

Project Number:
0721624V

Russell S. Kemp, PE
Principal



Certification [(f)(3)(I)]

I certify that this Risk Reduction Plan meets the requirements for such plans set forth in South Coast Air Quality Management District Rule 1402(f)(3) and that I am officially responsible for the processes and operations of the Exide Technologies lead recycling facility in Vernon, California.

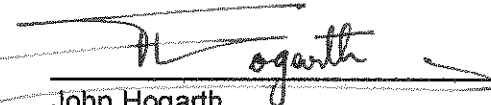

John Hogarth
Plant Manager

Contents

	Page
Executive Summary	ES.1
1 Introduction	1
2 Facility Identification [(f)(3)(A)]	2
3 Risk Characterization [(f)(3)(B)]	3
4 Sources Requiring Risk Reduction [(f)(3)(C)]	6
5 Evaluation of Available Risk Reduction Measures [(f)(3)(D)]	14
6 Specification of Risk Reduction Measures [(f)(3)(E)]	24
7 Schedule [(f)(3)(F)]	25
8 Estimation of Post-Implementation Risk [(f)(3)(H)]	22

List of Tables

Table 1:	MEIW Risk Contributions – Post Isolation Door	13
Table 2:	MEIW Cancer Risks of Metal Emissions from Four Exide Stacks	15
Table 3:	MEIW Cancer Risks of Metal Emissions from Eight Exide Stacks	18

List of Appendices

Appendix A:	May 2, 2013 Memorandum on Preliminary Testing of Door Effectiveness
Appendix B:	Updated Emission Inventory and Health Risk Assessment
Appendix B.d:	Updated Emission Inventory and Health Risk Assessment – AQMD Test Data
Appendix C:	Feasibility Study – SCAQMD Rule 1420.1(o)
Appendix D:	Projected Health Risks Following All Proposed Measures
Appendix E:	HRA CD-ROM

List of Attachments

Attachment A:	Blast Furnace Enclosure
Attachment B:	Blast Furnace Slag Tap Hood
Attachment C:	Scrubbing System Flow Balance

Executive Summary

In January 2013, Exide submitted a Health Risk Assessment (HRA) for its facility in Vernon, California, pursuant to the requirements of AB2588 and AQMD Rule 1402. On March 1, 2013 the South Coast Air Quality Management District (AQMD) approved Exide's HRA. Since that time, Exide and AQMD have mailed notices and held public meetings informing the neighboring community of the risks presented in that HRA, some of which exceeded Rule 1402's Action Risk Levels requiring reduction.

Following the HRA approval, Exide promptly installed an isolation door on the feed chute to the Vernon facility's blast furnace in order to reduce the potential for arsenic emissions from the Hard Lead Ventilation System Stack. Exide conducted preliminary engineering testing of the emissions from that stack in April 2013, the results of which indicated that the isolation door was effective in substantially reducing emissions of arsenic and organic toxics from the Hard Lead Ventilation System Stack. Formal emission testing following full AQMD testing protocols to confirm this performance commenced on August 13, 2013. Results from that complete series of tests were submitted to AQMD in October 2013 and final test reports from that testing were submitted to AQMD in early November 2013. In addition, AQMD staff conducted tests on several stacks in August and September 2013, the results from which were reported on October 17, 2013.

Based on available data, including data developed by AQMD, Exide reasonably believes that the isolation door has already reduced emissions sufficient to reduce risks to well below the Rule 1402 Action Risk Levels. Exide achieved these reductions prior to the Risk Reduction Plan (RRP) submittal deadline. Exide submitted an initial Risk Reduction Plan on August 28, 2013, which was based upon the preliminary testing conducted in April 2013.

AQMD issued a letter on October 24, 2013 disapproving the August 28, 2013 RRP and making recommendations in a number of areas. Though Exide respectfully does not concur with all of the points made in the October 24, 2013 letter, it submitted a revised RRP on November 26, 2013 addressing AQMD's primary issues and proposing a number of additional measures designed to ensure that Exide can consistently and permanently maintain the reduced post-isolation door emission levels.

On December 17, 2013, AQMD requested that Exide clarify certain points in the November 26, 2013 revised RRP. Exide responded by letter on December 30, 2013. Exide and AQMD staff met to discuss these clarification points in person on January 2, 2014. An Amended Revised RRP was submitted on January 17, 2014 in response to all those discussions and exchanges. AQMD issued Provisional and Conditional Approval of the Amended Revised RRP by letter on February 12, 2014 in which further detail was requested. A Final RRP—referred to below as the "March 2014 RRP"—was submitted in March 2014 and subsequently approved by AQMD.

After consultation with District staff in July 2014, Exide made a revision to the design set forth in the approved March 2014 RRP. In this revised design, the ventilation gases captured by Charge Hood at the top of the Blast Furnace will be treated separately from the Blast Furnace process gases. The ventilation gases from the charge enclosure at the top of the blast furnace

will first pass through a cartridge filter to remove particulates before flowing through a regenerative thermal oxidizer (RTO). The treated ventilation gases will then be combined with gases collected from the slag tap and the refining kettle hoods before being sent to the new Blast Furnace Baghouse #2 APC train (with subsequent wet scrubbing) for further emission control.

Exide believes that this Revised Final RRP is robust and fully responsive to all AQMD input and feedback provided thus far during this process.

This Revised Final RRP presents updated risk information based on the results of the above-referenced post-isolation-door stack testing (both Exide's and AQMD's testing) along with the additional emission and risk reduction measures that Exide proposes to install. This Revised Final RRP sets forth implementation schedules for the proposed measures and provides an assessment of the expected emission and risk levels following completion of all proposed projects.

In summary, Exide is committed to install further control equipment for both metals and organic compound emissions even though the data demonstrate that the measure already completed is sufficient to comply with Rule 1402's requirements. These additional measures are expected to be installed within approximately nine months of this Revised Final RRP submittal, which is less than 1/4 of the time allowed under Rule 1402.

The measures proposed for installation under this Revised Final RRP are as follows:

A new venturi and tray type wet scrubbing system will be installed to serve the main air pollution control system (APCS) function for the Blast Furnace, removing this load from the existing Neptune scrubbing APCS system. The existing Neptune scrubber will continue in service for the reverberatory furnace. Installation of this second wet scrubbing system will allow the primary process draft to each furnace to be managed independently to reduce emissions and maintain appropriate pressure in both furnaces pursuant to amended Rule 1420.1. This modification will also reduce emissions of metal and organic constituents as limited in amended Rule 1420.1.

Ventilation hoods now connected to the Hard Lead Ventilation System serving the charging area at the top of the blast furnace will be redirected to a new cartridge collector and Regenerative Thermal Oxidizer (RTO) before being directed through the main APCS train serving the Blast Furnace, including a new wet scrubber..

A new enclosure within the overall Blast Furnace partial enclosure will be installed around the furnace charge area so as to serve as a further hood to enhance capture of gases escaping the charge isolation door by the hoods at the top of this enclosure. **The current partial enclosure in which the Blast Furnace resides will be enhanced with sealed siding and close-fitting doors**

A radar-based charge level sensor will be installed within the blast furnace in order to provide operators with ongoing data regarding the level of the feed burden within the furnace.

A temperature sensor will be installed within the top of the Blast Furnace as a further operational indicator.

The ventilation hood now connected to the Hard Lead Ventilation System serving the slag tap of the Blast Furnace will be enlarged, served with greater air flow, and redirected to a baghouse that will be routed to the new wet scrubbing system.

The existing ram feeding mechanisms on the Reverberatory Furnace will be replaced with screw feeders to reduce the potential for organic-bearing process gases to be drawn into the Soft Lead Ventilation System pickup hooding when the ram feeders cycle.

The ventilation hooding serving two refining kettles will be removed from the Hard Lead Ventilation System and redirected to a baghouse that will be routed to the new wet scrubbing system. In the future, arsenic additions in refining operations will be restricted to these two kettles.

A regenerative thermal oxidizer (RTO) will be installed on the reverberatory furnace feed dryer exhaust to reduce emissions of organic gases.

Secondary High Efficiency Particulate Air (HEPA) filtration will be installed downstream of the Hard Lead Ventilation System baghouse, the Soft Lead Ventilation System baghouse, and the MAC baghouse to reduce emissions of lead, arsenic, and other metals. Following these installations, all baghouses at the facility will have secondary filtration provided either by a wet scrubber or HEPA.

A multiple-metals Continuous Emission Monitor will be temporarily installed for evaluation purposes on the Hard Lead Ventilation System stack as part of the pending Rule 1420.1 demonstration program for this technology.

These risk reduction measures will be accomplished at various times during 2014 in a staged fashion, contingent upon timely AQMD permit review and approval. Permit applications for a number of these measures have already been submitted to AQMD for consideration.

1 Introduction

On March 1, 2013 the AQMD approved the HRA submitted by Exide for its facility in Vernon, California. That approval letter summarized the projected risk levels presented in the HRA and identified several metrics above the Action Risk Levels set forth in Rule 1402. Pursuant to Rule 1402(f)(2), facilities with risks in excess of these Action Risk Levels must submit a RRP within 180 days of HRA approval which, in the case of the Exide facility, was August 28, 2013. Exide submitted an RRP before August 28, 2013, as required. AQMD rejected the initial RRP by letter on October 24, 2013. Exide submitted a revised RRP on November 26, 2013, an Amended Revised RRP on January 17, 2014, and the March 2014 RRP on March 4, 2014. Exide now submits this Revised Final RRP in satisfaction of Rule 1402(f)(2) requirements and in response to feedback provided by AQMD

Rule 1402(f)(3) outlines the contents to be included in such Risk Reduction Plans. To facilitate review, this document tracks that outline.

Since the approval of this facility's HRA on March 1, 2013, Exide has provided public notice and conducted multiple public meetings in collaboration with AQMD in accordance with Rule 1402(p). Most importantly, Exide promptly addressed the primary source of risk -- arsenic emissions from the facility's Hard Lead Ventilation System stack -- with the installation of a feed chute isolation door on the facility's blast furnace. This proactive measure reduces the potential for blast furnace process exhaust to enter that ventilation system. Exide conducted preliminary engineering testing on the Hard Lead Ventilation System stack in early April 2013. Results of that testing indicate that the door has been effective in reducing arsenic emissions from this stack to a degree that reduces the health risks to below the Action Risk Levels required by Rule 1402(e)(1). These emission reductions were confirmed in extensive testing conducted by both Exide and AQMD in August and September of 2013.

Despite having achieved compliance with Rule 1402, Exide presents in this Revised Final RRP additional risk reduction measures that it expects to install over the first quarter of 2015 to further reduce emissions and health risk from the facility, and to provide greater certainty in response to AQMD's concerns about maintaining the risk reductions. Exide reserves the right to amend or modify this RRP depending on the results of future AQMD rulemaking that may impact the facility.

The primary elements of this plan are as follows:

- An update on the "current" risk from the facility based upon latest testing data obtained by Exide and AQMD in August and September 2013,
- Additional control measures Exide commits to further reduce emissions,
- A projection of the future expected risk from the facility after implementation of all these measures, and
- Schedules associated with all these activities.

2 Facility Identification [(f)(3)(A)]

This Plan is for the following facility:

Exide Technologies
2700 South Indiana Street
Vernon, California 90058

AQMD Facility ID 124838
SIC Code 3341, NAICS Code 331492

3 Risk Characterization [(f)(3)(B)]

The January 2013 AB2588 HRA for this facility, as approved in the AQMD's March 1, 2013 letter, indicated the following key risk metrics:

Maximum Exposed Individual Worker cancer risk	156 in one million
Maximum Exposed Individual Resident cancer risk	22 in one million
Cancer Burden	10
Maximum Chronic Hazard Index, Worker	63
Maximum Chronic Hazard Index, Resident	2.9
Maximum Acute Hazard Index, Worker	3.7
Maximum Acute Hazard Index, Resident	0.2

These theoretical risks were calculated using results from facility-wide emission testing for AB2588 compounds conducted largely in late 2010 and early 2011. Subsequent retesting of emissions from the Hard Lead Ventilation System stack and the Neptune Scrubber stack was conducted in 2012. The risk assessment was conducted using the average emission rates between these 2010 and 2012 tests as fully tabulated in the January 2013 HRA.

Analysis of the HRA results and concurrent research determined that approximately 90 percent of the above-tabulated risks were due to emissions of arsenic from the Hard Lead Ventilation System stack and that the source of that arsenic was movement of blast furnace process exhaust from the blast furnace charging chute into hooding served by the Hard Lead Ventilation System. These process exhausts are intended to leave the blast furnace via the downstream afterburner, baghouse, and Neptune Scrubber, which are very effective at controlling arsenic emissions. Exide determined that preventing this process exhaust from entering the Hard Lead Ventilation System hooding was the fundamental solution to reducing the arsenic emissions and associated risk.

Promptly after AQMD approval of the HRA on March 1, 2013, Exide designed an isolation door on the charge chute to the facility's blast furnace to minimize the potential for blast furnace process exhaust gases to be drawn into the hooding served by the Hard Lead Ventilation System. This door system was permitted on March 28, 2013, and became operational on April 4, 2013. This door remains closed except to open briefly when charge material is actually being added to the furnace, which is only a small percentage of the time.

Exide conducted preliminary engineering stack tests on the Hard Lead Ventilation System stack over four days in the first two weeks of isolation door operation. AQMD staff observed many of these tests and AQMD's laboratory was provided physical splits of the samples collected by Exide's testing contractor. In addition, AQMD personnel conducted a test of the emissions of metals from the Neptune Scrubber stack on April 18 and 19, 2013.

Appendix A contains the May 2, 2013 memorandum describing the results of the preliminary engineering stack tests conducted in April 2013 to assess the effectiveness of the isolation door in reducing arsenic emissions from the Hard Lead Ventilation System stack. Key findings of this preliminary engineering assessment are:

- Arsenic emissions from the Hard Lead stack are reduced by 98 to 99 percent,
- Benzene and 1,3-butadiene emissions from the Hard Lead stack are reduced by 96 to 99 percent, and
- The linked reduction in arsenic and organic toxic emissions from the Hard Lead stack supports the conclusion that blast furnace process exhaust had previously caused the elevated arsenic emissions.

Emissions measured by AQMD from the Neptune Scrubber stack were comparable to those used in the HRA, indicating that the improved retention of the blast furnace process exhaust gases in the Neptune Scrubber air pollution control system does not adversely affect emissions and risk.

As specified in the air permit issued for the installation of the isolation door on March 28, 2013, Exide conducted further emission testing to confirm these improvements. After consultation with the AQMD, this testing was expanded to include the full suite of AB2588 metals for the Hard Lead, Soft Lead, and Neptune Scrubber stacks conducted simultaneously, as well as inclusion of the full set of organic toxic air contaminant emissions addressed in the HRA. AQMD was provided splits of all samples.

Exide was prepared to perform this testing promptly after isolation door installation, but the testing was unavoidably delayed because Exide was forced to cease operations for more than seven weeks pursuant to the Department of Toxic Substances Control's April 24, 2013 Suspension Order. Exide recommenced operations after a Judge issued a preliminary injunction staying DTSC's Order. Exide started source tests on August 13, 2013, which continued over 15 days in a period spanning about six weeks.

Based on Exide data collected to date, the *"risk due to total facility emissions has... decreased below the levels indicated in the previously approved health risk assessment."*[Rule 1402(f)(3)(B)] Further to the data presented in the Appendix A memorandum, complete risk calculations have been repeated using all the input data from the approved 2013 HRA and substituting the emissions data collected in August and September 2013 by Exide from the Hard Lead, Soft Lead, and Neptune Scrubber stacks. This "updated air toxics emission inventory and health risk assessment" is included as Appendix B.

In summary, this updated assessment in Appendix B indicates the following key risk metrics:

Maximum Exposed Individual Worker cancer risk	5.8 in one million
Maximum Exposed Individual Resident cancer risk	2.1 in one million
Cancer Burden	0.05

Maximum Chronic Hazard Index, Worker	0.5
Maximum Chronic Hazard Index, Resident	0.05
Maximum Acute Hazard Index, Worker	0.1
Maximum Acute Hazard Index, Resident	0.009

Each of these risk metrics is BELOW the Action Risk Levels specified in Rule 1402.

In addition, AQMD conducted tests of the Hard Lead and Soft Lead stacks in August and September 2013 and had a contractor test emissions from the North and South Torit building ventilation system stacks in September 2013. A second set of “current case” risk calculations was performed substituting in these AQMD data for those stacks and pollutants tested and are presented. This “updated air toxics emission inventory and health risk assessment – AQMD data,” is included as Appendix B.d.

In summary, this updated assessment using AQMD data, which is presented in Appendix B.d, indicates the following key risk metrics:

Maximum Exposed Individual Worker cancer risk	9.8 in one million
Maximum Exposed Individual Resident cancer risk	2.7 in one million
Cancer Burden	0.2
Maximum Chronic Hazard Index, Worker	1.9
Maximum Chronic Hazard Index, Resident	0.1
Maximum Acute Hazard Index, Worker	0.2
Maximum Acute Hazard Index, Resident	0.009

Each of these risk metrics derived from AQMD testing is BELOW the Action Risk Levels specified in Rule 1402, and all are comparable to those computed from the preliminary April engineering testing described in Appendix A.

In summary, whether based on Exide data or AQMD data, Exide’s current emissions and risk profile satisfy Rule 1402 standards.

4 Sources Requiring Risk Reduction [(f)(3)(C)]

As identified in the January 2013 HRA, 90% of the calculated facility cancer risk is due to arsenic emissions and 4% of the calculated facility cancer risk is due to 1,3-butadiene emissions. Further, the Hard Lead Ventilation Stack accounted for 97% of the facility's annual arsenic emissions and 67% of the facility's 1,3-butadiene emissions. Therefore, the Hard Lead Ventilation System stack is the source requiring risk reduction to achieve the Rule 1402 Action Risk Levels. As shown through the updated risk calculations of Appendix B, which indicate the degree of risk reduction associated with control/reduction of the arsenic and 1,3-butadiene emissions from the Hard Lead Ventilation System stack due to the isolation door installation, control of this stack's emissions will be sufficient to achieve the Action Risk Levels.

Despite Exide's ability to achieve needed risk reductions via the isolation door on the Hard Lead Ventilation System stack, Exide (in good faith and while reserving its legal rights and right to modify) will install additional control measures on a number of other sources to reduce risks even further below those depicted in Appendix B. In particular, Exide will install the following additional air pollution control devices to further reduce calculated risks from the facility:

Secondary High Efficiency Particulate Air (HEPA) filtration will be installed downstream of the following baghouses, reducing their emissions of lead, arsenic, and other toxic metals:

- **Hard Lead Ventilation System Baghouse**
- **Soft Lead Ventilation System Baghouse**
- **MAC Baghouse**

A Regenerative Thermal Oxidizer (RTO) will be installed on the Reverberatory Furnace Feed Dryer exhaust to reduce emissions of 1,3-butadiene and other organic toxics.

A Regenerative Thermal Oxidizer (RTO) will be installed to reduce emissions from the Blast Furnace Charge Hood ventilation air.

Note that the facility has already installed secondary HEPA filtration downstream of both the North and South Torit cartridge collectors, the Material Handling baghouse, and the feed dryer baghouses. These four HEPA installations were made AFTER the testing conducted for the AB2588 Emissions Inventory and the effect of their improvement is NOT reflected in the January 2013 HRA results. The effect of the HEPA installation on the Torit units is reflected in the updated risk results presented in Appendix B based upon the testing conducted in September 2013.

Exide diligently reviewed the District's October 24, 2013 letter, feedback on the November 26, 2013 revised RRP, and the District's February 17, 2014 letter in the context of its operations,

has proposed several measures expected to address the AQMD's concerns, and has provided further detail by letter on March 4, 2014.¹

Exide will make the following modifications and expansions to existing air pollution control systems in order to improve the consistency and reliability of the prevention of process gas introduction into the Hard Lead and other ventilation systems without having primary reliance on the function of the recently installed isolation door:

Install a second wet venturi scrubbing system for the control of direct furnace process exhaust to operate in tandem with the existing Neptune scrubber system. This new scrubbing system will primarily provide control of the blast furnace process emissions. This change will provide greater overall process gas handling capacity, increasing the primary draft on both furnaces. This measure satisfies and is in response to Item 2 of AQMD's October 24, 2013 letter. The planned capacity increase for the primary APCS scrubbing system will be designed such that sufficient gas cooling is provided via internal spray cooling (reverberatory furnace) and cooling loops (blast furnace) and enhancement to the blast furnace air/water heat exchanger (described further below) so as to limit the introduction of tempering air for cooling to only on an emergency basis (AQMD October 24, 2013 letter, Item 4). Initial conceptual planning is to have the new scrubber provide primary control for the blast furnace and the existing scrubber will provide primary control for the reverberatory furnace. The new scrubbing system will be a wet Venturi scrubber followed by a tray type scrubber similar in arrangement and technology to the current Neptune Scrubber APCS. The design specifications call for the draft capacity to be sufficiently sized to achieve and maintain a negative pressure of at least 0.02 inches of water in each furnace on a 30-minute-average basis. The venturi section future operating pressures will be established during the demonstration stack testing. The initial conceptual basis for such pressures will be those specified in conditions C8.5 and C8.6 of the facility's current Title V permit of at least 20 inches water for the new scrubber controlling the blast furnace and 26 inches water for the existing scrubber controlling the reverberatory furnace.

The current reverb furnace primary APCS includes two shaker style baghouses (C40 and C41) for direct process gas exhaust gas filtration, each of which has sufficient capacity to control the entire reverberatory furnace exhaust flow on its own.

In the future configuration, the northern of these baghouses (C40) will be dedicated to the reverb furnace primary APCS utilizing the existing fan. This unit has 510 bags of Teflon membrane on Teflon substrates with 21,362 square feet of cloth area. At the design flow of 27,000 acfm for the direct reverb offgas, the resulting air-to-cloth ratio is only 1.25, which is well within the capability of a shaker baghouse in this industry.

¹ By submitting the March 2014 RRP or this Revised Final RRP, Exide is not waiving any legal rights associated with the AQMD's October 24, 2013 rejection of the initial RRP, nor is Exide making any admissions with regard to the points raised by AQMD. For instance, Exide continues to reasonably believe that its existing systems operate as designed and permitted and that constant negative pressure is unnecessary for emission control, but submits this Revised Final RRP in a good faith effort to reduce emissions and risk and to satisfy District Rules.

The southern of these baghouses (C41) will be repurposed to serve as baghouse “Blast Baghouse 2” to filter flow from the enlarged blast furnace slag tap hood and two refining kettle hoods described in Item 1 above, as well as the flow from the blast furnace charge hood following treatment in a new Blast Furnace RTO. This unit will continue to have 21,362 square feet of cloth with bags having Teflon membranes on Teflon substrates. Total flow into this unit is expected to be 32,500 acfm, resulting in an air-to-cloth ratio of 1.5.

The other portion of the flow from the enlarged blast furnace slag tap hood and two refining kettle hoods described in Item 1 above, as well as the flow from the blast furnace process gases will be routed to the current Blast Furnace baghouse, which will be fitted with a new exhaust fan. The current blast furnace baghouse will continue to have 22,620 square feet of cloth with bags having Teflon membranes on Teflon substrates. Total flow into this unit is expected to be 32,500 acfm, resulting in an air-to-cloth ratio of just over 1.4.

This future ventilation arrangement is presented in a drawing in **Attachment C**.

The repurposed Blast Baghouse 2 will be fitted with a new exhaust fan. Exhaust from this baghouse and fan will be routed to the new blast furnace venturi/tray scrubbing system. This baghouse and the current blast furnace baghouse are not currently, and will not in the future, be followed by HEPA filtration because they will be followed by wet scrubbing systems to provide secondary control of unfilterable particulate matter. As stated as a general principle, at the conclusion of these modifications all facility primary control devices (e.g., baghouses) will be followed by secondary control – either HEPA or wet scrubbing.

Air permit applications for this baghouse service conversion and fan installations for the repurposed C41 baghouse and existing blast furnace baghouse C45 were submitted by April 10, 2014 as required by Rule 1420.1.

Construction work for this baghouse repurposing will be performed concurrently with the new scrubber installation.

Attachment C also presents tabular flow balance information for the loads to each of the two scrubbing systems, both the existing one that will serve reverberatory furnace and the new one that will serve the blast furnace. As described above, the blast furnace primary APCS flow, carrying blast furnace process gases will be routed through the current tube cooler and blast furnace baghouse. Some of the blast furnace ventilation gases will be combined with the process gases to the inlet to the blast furnace baghouse. The combined gas streams exiting the baghouse will be split, with most of the stream (approximately 70%) routed to the new scrubber and the balance of the stream (approximately 30%) routed to the existing scrubber.

We note that the flow budget through this blast furnace process gas system allows for 15,000 cfm of process exhaust from the blast furnace itself. This compares favorably with the 10,000 cfm basis described in the afterburner analysis of the current configuration in the AQMD’s Engineering Report on A/N 374180 (page 20 of 34). Accordingly, draft for the blast furnace chamber will be enhanced to ensure maintenance of negative pressure in that vessel as required under Rule 1420.1.

Ventilation gases captured from the blast furnace charging hood and top enclosure will be directed to a new cartridge filter to remove particulates prior to flow to a new RTO. This treated gas stream will be combined with the ventilation gases from the refining kettles and slag tap hood and introduced into the new Blast Furnace #2 Baghouse control train.

The reverberatory furnace will be exhausted to the current wet scrubbing system at a budgeted air flow of 27,000 cfm. Exide operates the APCS as currently designed and permitted by the District. This new design means that the reverb furnace will have ventilation capacity independent of the blast furnace. This will allow Exide to utilize the full ventilation capacity of the reverberatory furnace baghouse and fan to ensure maintenance of negative pressure as required under Rule 1420.1.

Overall scrubber capacity more than doubles under this configuration and the air allocated to the direct process gas handling of each furnace increase even though the scrubbing systems are also handling other sources as well.

Flow from the two scrubbers will be combined into a common stack at the location of the current Neptune Scrubber stack, with the same height but a larger diameter to accommodate the increased flow.

As a further measure to backstop the function of the isolation door and the improved furnace draft provided by the expanded scrubbing capacity, **Exide will redirect the ventilation hoods serving the charge area atop the blast furnace from the Hard Lead Ventilation System to the inlet side of a new RTO.** This change will ensure that these gases will be directed through the RTO for the reduction of organic emissions and, subsequently, wet scrubbing control downstream of the primary blast furnace process baghouses.

Exide will not be enhancing the current afterburner because doing so would generate excess NO_x emissions that would not meet District emission requirements. Instead, Exide will maintain the existing afterburner configuration of two, 5-MMBtu/hr burners that are able to increase the oxygen content in the combustion air needed to consume the CO and VOCs from the Blast Furnace process gases.

Processing this gas stream in an afterburner would have required a significantly larger afterburner than what was originally proposed in the March 2014 RRP. In order to operate the blast furnace charge hood so that it would be capable of capturing all of the ventilation air, including any gases that may exit the furnace during charging, the design was modified to control these gases separately from the furnace process gases.

The ventilation gases from the blast furnace charge hoods will be vented to a new cartridge filter to reduce particulate loading prior to further emission controls in a new blast furnace RTO. A new blast furnace charge hood fan will be installed to provide for complete capture of ventilation gases at all times, including cold startups.

Ventilation gases exiting the RTO will be combined with gases captured from refining kettles #1 and #2 and the enlarged slag tap hood, and routed to the newly reconfigured Blast Furnace Baghouse #2 and the new scrubber for continued emission control.

Further, **Exide will enhance the enclosure within which the blast furnace is situated to maximize capture of gases that escape from the blast furnace charging door and route them through the cartridge filter and RTO** rather than potentially reaching the Torit building ventilation system. This enclosure enhancement will take the form of a replacement of the siding forming the current enclosure with a sealed skin and close-fitting doors wherever access is required at those upper levels. This enhanced enclosure structure will serve as a hood itself to ensure capture of gases potentially released from the furnace charging area. Any released process gases would be hotter than the surrounding atmosphere and would rise into the collection system that will now be routed to the cartridge filter and RTO and subsequent scrubber. **Attachment A** includes preliminary drawings/graphics describing the enclosure improvement project and showing how currently open spaces or doorways will be closed. This will improve and maintain emission reductions.

Further, **a new enclosure within the overall blast furnace partial enclosure will be installed around the furnace charge area** so as to serve as a further hood to enhance capture of gases escaping the charge isolation door by the hoods at the top of this enclosure. **The current partial enclosure in which the blast furnace resides will be enhanced with sealed siding and close-fitting doors.** The blast furnace charging area is at the third level within this current larger enclosure at which there is a personnel landing at the level of the charge thimble. Exide proposes to install a second inner enclosure at this level. Within this inner enclosure will be the current collection hoods (the slot hood behind the isolation door and three other existing hoods currently routed to the Hard Lead Ventilation System) with an aggregate flow of 25,000 cfm. These hoods would capture emissions escaping beyond the isolation door and their exhaust will be rerouted into the inlet of the blast furnace cartridge filter and RTO for organic emission control. This level has an opening down through the skip hoist tunnel.

To maximize the inward draw through other remaining openings into this new charge level inner enclosure, and to cancel any chimney effect up and through the skip hoist tunnel toward the ventilation extraction at the top of the furnace, a portion of the hard lead baghouse ventilation flow that is being “freed up” by the removal of a number of sources to that system (two refining kettles, blast furnace slag tap hood, and hoods at blast furnace charge area) will be used to impose suction at the bottom section of the skip hoist tunnel, creating a pressure null point within that tunnel. Thus, air will not be drawn up this pathway to the hooding at the charge area. The remaining openings (exclusive of the skip hoist tunnel) to this new inner enclosure will be limited to an aggregate cross sectional area of 125 square feet. Thus, the inward draft velocity through the openings to this new inner enclosure of the blast furnace charge area will be $25,000 \text{ cfm} / 125 \text{ square feet} = 200 \text{ feet/minute}$.

This new inner enclosure will sit within the top reaches of the current overall blast furnace partial enclosure which is to be fitted with new siding and doors that can be closed. Exide proposes to replace and/or otherwise seal the siding which comprises the current enclosure around the blast furnace and to install doors where ingress/egress points above the floor level for that enclosure

are currently open. **Attachment A** includes a preliminary drawing describing the enclosure improvement project and showing how the siding will be replaced and currently open gaps or doorways will be closed. This outer enclosure forms a larger bell which has a bottom extent below the thimble height, further facilitating capture from the charge area due to the chimney effect of the heated gases.

This double layer of enclosure and extraction will direct the blast furnace charging area fugitives that might escape the isolation door to the cartridge filter and RTO and subsequent wet scrubbing primary APC systems.

In order to improve process operational control, **Exide will install a radar-based level sensor within the blast furnace in order to provide operators with ongoing data regarding the level of the feed burden within the blast furnace.** Maintaining the charge height is a key aspect for preventing the escape of process gases from the furnace. The installation of the isolation door has been effective for its intended purpose but has eliminated visual observation as a means of tracking the height of the feed burden in the furnace. By maintaining the desired charge height, feed will remain in contact with the bottom of the feed thimble in the charge chute, and the material within the thimble will provide a seal minimizing the potential for gaseous escape through the isolation door even when opened. **In addition, Exide will install a temperature sensor inside the top of the blast furnace as a further operational indicator to guide operators in maintaining the furnace at its desired condition.** If the charge level is too low, the charge burden thickness is reduced, which would lead to increased heat in the top of the furnace that would be detected by this temperature sensor.

Exide will make the following changes to the ventilation system arrangement so as to direct potential sources of gaseous or unfilterable arsenic emissions from the Hard Lead Ventilation System Baghouse to a baghouse followed by wet scrubbing:

Redirect the ventilation hoods from two refining kettles in the hard lead section of the refinery from the Hard Lead Ventilation System and reroute the hooding to a baghouse that exhausts into the new wet scrubber serving the blast furnace.

Metallic arsenic additions will be restricted to be made only in one of these two rerouted kettles (Kettles 1 and 2 – Title V permit devices D7 and D9) in the hard lead section of the refinery. The ventilation for these kettle hoods is currently routed to the Hard Lead Baghouse. As part of the Amended Revised RRP, this ventilation will be rerouted to the repurposed portion of the reverb baghouse (see Item 2 below) and existing blast furnace baghouse for subsequent wet scrubbing emission control. Each kettle hood is served by 5,500 cfm of ventilation. Exide is changing the routing of the control device, but is not planning to change the current hoods. These current hoods perform well, as demonstrated by the regular hood face velocity monitoring which shows measurements above the pre-2012 NESHAP hood performance specification of 250 ft/minute.

Redirect the ventilation hood serving the slag tap on the blast furnace from the Hard Lead Ventilation System and reroute the hooding to a baghouse that will exhaust into the new wet scrubber serving the blast furnace. This hood will also be enlarged and reshaped to provide greater interior hood volume to allow high velocity

discharge gases to slow and facilitate capture by the hood. The current air volume dedicated to this hood will be increased by approximately 20% above current hood flow to also improve hood capture performance. Based upon the functional arrangement of the blast furnace itself, organic gases evolved during the smelting process would rise in the furnace and be drawn from the top of the furnace into the new RTO. Any other gases would also be from the charging door area at the top of the furnace, already being addressed by the rerouting of the charging area hygiene ventilation hoods into the RTO. Such gases would not traverse downward through the high pressure area at the smelting zone where the blast air is introduced, above the slag layer. Thus, the proposed enhanced APC approach for this hood will be venturi scrubbing to address the limited potential that exists for unfilterable metal contaminant (arsenic) emissions, but not introduction into the RTO. **Attachment B** includes preliminary drawings of the new hood showing its dimensions. The current slag tap hood is served by 12,000 cfm of air from the Hard Lead Ventilation System. In the future, this larger hood will be served by 14,000 cfm of air routed to the repurposed portion of the reverb baghouse (see Item 2 below) and current blast furnace baghouse for subsequent wet-scrubbing emission control. This hood has two access doors, one larger door measuring 53 x 45 inches for moving slag pots in and out of the hood and a smaller door measuring 9 x 13 inches for lancing access. This open-door cross sectional area is 17.4 square feet through which 14,000 cfm of extraction would impose an inward velocity of $14,000/17.4 = 800$ ft/minute. This 800 ft/minute expected hood face velocity design level will ensure effective hood performance and emission capture. By comparison, the pre-2012 NESHAP hood performance specification for this industry was 300 ft/ minute.

With these ventilation arrangement changes, Exide will be removing a significant amount of the current load from the current Hard Lead Ventilation System as sources such as the two refining kettle hoods, blast furnace slag tap hood, and the blast furnace charging area hoods are routed instead to other control devices, terminating with wet scrubbing. The Hard Lead Ventilation System total flow will not be reduced or downsized. Rather, the capacity freed by removal of these sources will be redirected to general building ventilation extraction on the smelting/refining building and/or the baghouse row enclosure and the extraction on the skip hoist tunnel described above. Such retention of extraction by the overall Hard Lead System will ensure that total enclosure negative pressure performance will not be compromised by these changes.

Exide will also make the following process change:

Replace the existing ram feeding mechanisms on the reverberatory furnace with screw feeders. This will reduce the potential for organic-bearing reverberatory furnace process gases to be drawn into Soft Lead Ventilation System pickup hooding when the ram feeders cycle.

As a potential future means to provide an ongoing and continuous measure of the effectiveness of the isolation door and furnace ventilation systems to retain furnace process gases within the blast furnace, **Exide will temporarily install a multiple-metals continuous emission monitor on the Hard Lead Ventilation System** as part of the pending Rule 1420.1 demonstration

program for this technology. Such a direct measure of effectiveness, if proven effective, has the potential to address District concerns about using an indirect furnace pressure metric.

5 Evaluation of Available Risk Reduction Measures [(f)(3)(D)]

This section will first consider the available measures to reduce emissions and risk from the levels presented in the January 2013 HRA, and will then consider the measures available to reduce emissions further from the post-isolation-door levels presented in Appendix B. This two-step evaluation is warranted because the effectiveness of reducing risk through addressing various pollutants and source points is different at each step.

As outlined in Section 1402(f)(3)(D), the factors to be evaluated for risk reduction measures include emission and risk reduction potential, cost, and time to implement. Starting from the risk levels presented in the January 2013 HRA, and as described above, it was clear to Exide and the AQMD that addressing arsenic emissions from the Hard Lead stack (accounting for 90% of the calculated risk) as quickly as possible was the priority. In that respect, the evaluation of available risk reduction measures took on an early focus much in advance of the regulatory requirement to prepare and submit this Risk Reduction Plan. Assessment of the available emissions testing data showed that the elevated arsenic emission rates from this stack were accompanied by organic toxic emissions, giving strong indication that the underlying cause of elevated Hard Lead stack emissions was the entry of blast furnace process exhaust gases exiting the furnace through the furnace's charge chute into the Hard Lead Ventilation system hood situated adjacent to the charge chute. Exide and ENVIRON believe that these blast furnace process gases can contain forms of arsenic that are not completely filterable by mechanical means such that the Hard Lead baghouse would not effectively control them under certain circumstances, while the blast furnace process offgas system, including a wet scrubber, can and does control them (as evidenced by the available testing data on that exhaust).

Accordingly, with strong and appreciated AQMD cooperation and assistance, Exide proactively designed and implemented a measure directed at source control rather than "end-of-pipe" control to reduce these emissions. That is, at the initial stage, rather than focusing on alternate air pollution control technologies, the effort was directed toward better control of the process itself to ensure that emissions are directed to the existing air pollution control systems as intended and most suited to controlling those emissions. Exide determined that installation of a retractable isolation door at the blast furnace feed charge chute would provide a physical barrier that would block the potential for passage of process exhaust out of the charge chute approximately 95% of the time (when closed). The door would be controlled to open only as needed to allow the passage of charge materials from the skip hoist bucket into the furnace.

Exide designed and installed this feed isolation door within five weeks of AQMD approval of the January 2013 HRA. Exide worked diligently and in close cooperation with the AQMD, which issued an expedited permit to construct within a month of the HRA approval. The greatest value of this measure was the ability to implement it quickly— well ahead of any regulatory timeframes set forth in Rule 1402.

In terms of the risk-reduction potential of this measure, initial projections were based simply on a rough estimate of the percentage of time that the isolation door would remain closed. That is, Exide expected that the isolation door would reduce the arsenic emissions from the Hard Lead

stack by approximately 95% and that the door would reduce toxic organic emissions from that stack also by the same percentage via the prevention of the entry of furnace process exhaust gases into the hard lead ventilation system.

As presented in Appendix B, the emission reduction effectiveness of the isolation door, based upon the available data from testing conducted by Exide in August and September 2013, exceeded the 95% expectation for arsenic and toxic organic emissions from the Hard Lead stack. Most importantly, based on preliminary testing all risk metrics are below the Rule 1402 Action Risk Levels following the installation of the isolation door, by a comfortable margin:

Maximum Exposed Individual Worker cancer risk -	5.8 in one million	vs.	25
Maximum Exposed Individual Resident cancer risk -	2.1 in one million	vs.	25
Cancer Burden -	0.05	vs.	0.5
Maximum Chronic Hazard Index, Worker -	0.5	vs.	3
Maximum Chronic Hazard Index, Resident -	0.05	vs.	3
Maximum Acute Hazard Index, Worker -	0.1	vs.	3
Maximum Acute Hazard Index, Resident -	0.01	vs.	3

Exide has evaluated concepts for the replacement of the current isolation door with either a rotating airlock type of door or a “double door” that would never be open. Exide has studied the feasibility and potential benefits of upgrading the current isolation door to an air lock type, and Exide has reasonably determined that modifying the door is operationally infeasible and will likely not improve emissions reduction. As part of its analysis, Exide studied its other facilities. Exide’s facility in Canon Hollow, Missouri, has a blast furnace that is charged through a rotating drum type of isolation door. While that indicated that this was a possible approach worth considering, it has been determined that this type of door would not be readily transferrable to the Vernon configuration. The Missouri facility has a rather unique arrangement in that the facility is built on a hillside with significant elevation changes. The blast furnace’s feed room actually sits at a level even with the top of the blast furnace – at its charge point. This allows the front end loader in the feed room to simply drive over and drop the material directly into the rotating drum – there is no skip hoist needed given the elevation of the room. Integrating the rotating drum type of door with a skip hoist arrangement would be exceptionally complex and prone to mechanical failures. Further, the rotating drum type of feed door does not provide the “air lock” sought. In order to allow sufficient “play” in the rotating mechanism to avoid jams, Exide’s assessment is that the drum/door provides a constant seal, but one that is only about 90% effective (*i.e.*, it is not fully “air tight”). By comparison, the isolation door at Vernon is closed generally more than 95% of the time. We believe that emission reduction performance is better when the current isolation door is closed (95% of the time) as opposed to having a door that is only 90% effective all the time. That is, the current Vernon isolation door, for the unique Vernon arrangement, performs better than the rotating drum door at Exide’s Missouri facility.

Similarly, we do not believe that a double-door arrangement would be workable or more effective at the Vernon facility than the current isolation door. To accommodate a double-door system, the entire skip hoist feeding mechanism would have to be raised upward to provide the necessary spacing between the doors. Beyond this rearrangement challenge, we have great concern about the way such a double-door arrangement would eliminate the ability to observe

the bottom of the two doors to identify “snags” or other problems. Worse, it would be all but impossible to access the bottom of the two doors to clear snags or jams. Thus, again, we believe that the current single door arrangement is preferable and will prove most effective and reliable for its overall operational and emission-reduction function.

Further, this air-lock door measure is not appropriate in light of the other changes made to the RRP in response to AQMD comments. First, Exide is installing the new scrubber to address AQMD concerns regarding the primary capture of the blast furnace process gases – reducing the degree of “reliance” on the isolation door as desired by the AQMD. Second, Exide is proposing to route the hooding that would capture any gases getting past the isolation door through the new cartridge filter, RTO, and scrubber, providing the secondary level of fail-safe capture and control in a manner more reliable and effective than any upgrade to the isolation door itself. Third, Exide is proposing to enhance and tighten the enclosure within which the blast furnace sits in the facility to ensure that any gases escaping the door are, in fact, captured by this hooding around the top of the blast furnace and routed to the new a cartridge filter and RTO. All these measures in combination will address stated AQMD recommendations that all furnace process gases are contained or captured and routed through the intended APCS sequence (RTO, baghouse, and scrubber).

Rather than further pursue these possible different door configurations, Exide is pursuing the approach encouraged by AQMD in its October 24, 2013 letter to make fundamental ventilation improvements to reduce the degree of primary reliance on the door to prevent process gas escape. These improvements include increasing the capacity of the main furnace air pollution control system (APCS) (as recommended in item 2 of the AQMD letter of October 24, 2013) and installation of the blast furnace charge level sensor to insure maintenance of the thimble seal. Beyond these primary measures at prevention of escape, Exide is proposing to reroute the ventilation for the hoods that collect any gases that escape the isolation door through the blast furnace new RTO to subsequent final control by wet scrubbing. Further, as described above, Exide is proposing to upgrade the enclosure housing the blast furnace itself within the smelting building to essentially place the furnace within and under a hood that will ensure that any gases escaping the isolation door will, in fact, be captured and routed to the hoods that will now be vented to the RTO. This is one of several proposed measures that will aid in achieving the arsenic and organic mass emissions limits of amended Rule 1420.1.

In conclusion, Exide is not proposing installation of either a rotating drum mechanism or a double door because neither design is operationally feasible and neither design is necessary for emissions reduction. These were offered originally as possibilities to be evaluated, and Exide has done so and determined that they would not be as effective or reliable as the changes proposed for implementation. Exide is already in a position that achieves the Rule 1402 Action Risk Levels, yet it is also proposing extensive additional measures that address the issues associated with emissions from the blast furnace charging point in a more direct and robust manner. The proposals in the Revised Final RRP will reduce the reliance on the isolation door as a barrier to emissions by improving the basic draft of the main process APCS serving the blast furnace to achieve appropriate pressure within the furnace, exactly as requested by AQMD. Further, even after that is done, Exide is proposing to route all of the hooding at the top of the blast furnace through the RTO and wet scrubbing APCS. Thus, any gases that still might

escape the isolation door will be captured and routed through the desired APCS treatment. In this future configuration, any “enhancement” or upgrade to the isolation door itself would not result in any reduction of emissions over that already proposed, due to the secondary capture rerouting. This is a superior approach to having a “better door” because it renders the door itself superfluous.

As described above, Exide has concluded that there is the potential for unfilterable arsenic compounds to be generated during the addition of arsenic to refining kettles. It is important to note that the August and September 2013 testing programs included representative runs during which arsenic was added to kettles. Thus, while there is some unfilterable arsenic generated during this activity, the risks from the emissions are still below Rule 1402 requirements. Nonetheless, Exide has concluded that it will restrict the practice of arsenic addition to two specified refining kettles and the ventilation hooding for those kettles will be routed to a baghouse that is followed by the new blast furnace wet scrubber.

Remaining Risk Culpability and Contributors

The isolation door is a measure that has been implemented and is permanent, and its operation is already required by Title V permit. Its presence is required as of the date of preparation of this RRP analysis. We look next to what the risk “profile” from the facility is once the isolation door has the effect of bringing the Hard Lead stack performance into line. From that profile, we evaluate the spectrum of measures that could be employed to further reduce the post-isolation-door risks.

In particular, we present the following tabulations of the contributing sources and pollutants to the summary of risk metrics presented above and in Appendix B for the Post-isolation door case for the Maximally Exposed Individual Worker (MEIW), the highest risk scenario:

Table 1 Contributions to MEIW-Cancer Risk (contributions >1% listed)		
By Chemical		
Chemical Name	Cancer Risk	Contribution
Cr(VI)	2.31E-06	40%
Arsenic	9.10E-07	16%
PCBs	7.86E-07	14%
Benzene	7.41E-07	13%
1,3-Butadiene	4.81E-07	8%
Lead	2.26E-07	4%
Cadmium	1.15E-07	2%
Naphthalene	1.04E-07	2%
Other Chemicals	1.17E-07	2%

Table 1 Contributions to MEIW-Cancer Risk (contributions >1% listed)		
By Source		
Source	Cancer Risk	Contribution
Feed Dryer Stack	1.71E-06	30%
RMPS Stack	1.22E-06	21%
Hard Lead Stack	9.83E-07	17%
MAC Baghouse Stack	5.89E-07	10%
Material Handling Stack	5.07E-07	9%
Soft Lead Stack	3.45E-07	6%
Neptune Stack	1.95E-07	3%
Other Sources	2.41E-07	4%
By Source and Chemical		
Chemical and Source	Cancer Risk	Contribution
Cr(VI) from RMPS Stack	1.14E-06	20%
PCBs from Feed Dryer Stack	6.10E-07	11%
Benzene from Feed Dryer Stack	5.45E-07	9%
Cr(VI) from MAC Baghouse Stack	4.65E-07	8%
1,3-Butadiene from Feed Dryer Stack	2.91E-07	5%
Arsenic from Hard Lead Stack	2.87E-07	5%
Cr(VI) from Material Handling Stack	2.38E-07	4%
Arsenic from Material Handling Stack	2.31E-07	4%
PCBs from Hard Lead Stack	1.75E-07	3%
Cr(VI) from Soft Lead Stack	1.74E-07	3%
1,3-Butadiene from Hard Lead Stack	1.67E-07	3%
Benzene from Hard Lead Stack	1.58E-07	3%
Arsenic from MAC Baghouse Stack	1.19E-07	2%
Cr(VI) from Neptune Stack	1.06E-07	2%
Cr(VI) from Hard Lead Stack	9.40E-08	2%
Other chemicals/sources	9.90E-07	17%
Total	5.8E-06 or 5.8 in a million	100%

Several conclusions regarding potential further risk reduction are drawn from the above “culpability” tabulations:

- While calculated cancer risk from arsenic remains one of the principal contributing pollutants, the sources of arsenic contributing to the remaining, or “residual” risk, after the effect of the isolation door are more diffuse, involving more sources, and
- Calculated cancer risk from organic toxic air contaminants accounts for about 38% of this residual risk.

The diffusion of risk among the sources and pollutants leads to an analysis of finding where additional controls on particular sources would have the most effect.

Potential Further Controls

Initially, we considered reducing this MEIW maximum risk by the implementation of Wet Electrostatic Precipitation (WESP), a technology mentioned by AQMD for consideration in its March 1, 2013 HRA approval letter and its October 24, 2013 RRP rejection letter. WESP has proven to be able to achieve very low emission rates of toxic metals, but at very high cost and physical space requirements. The WESP technology has been employed at another lead recycling facility in Southern California on sources that are analogous to the following stacks at the Exide Vernon facility, listed with their associated risk contribution from all metals to the 5.8 in a million combined MEIW risk after installation of the isolation door.

Table 2 MEIW Cancer Risks of Metal Emissions from Four Exide Stacks	
Source	Combined MEIW risk, all metals
Neptune Stack	1.51E-07
Hard Lead Stack	4.37E-07
Soft Lead Stack	2.51E-07
Feed Dryer Stack	2.01E-07
Total	1.04E-06 or 1.04 in a million

This analysis assumes that a WESP would be 95% effective in reducing toxic metal emissions. Installation of the 215,000 cfm system (compared to Quemetco’s significantly smaller system size of approximately 100,000 cfm) that would be necessary to control the above-listed sources would have the effect of reducing the MEIW risk by 0.99 in a million, taking the facility-wide total down to 4.8 in a million, a 17% reduction in the overall risk from the facility. Even if the WESP were perfect in eliminating 100% of the metals emissions from these four stacks, the risk reduction at the MEIW would be 1.04 in a million.

This reduction would have a capital cost on the order of \$30 million based upon both Environmental Protection Agency (EPA) cost estimation data from the development of the revised National Emission Standards for Hazardous Air Pollutants (NESHAPS) for this industry and updated cost information presented in the “Feasibility Study, SCAQMD Rule 1420.1(o)” of

August 2011 included as Appendix C to this report. Further, as presented in Appendix C, space constraints essentially preclude the installation of such a system at the Exide Vernon facility. EPA directly considered and rejected the imposition of WESP controls as existing or new source MACT in the recent revision to the NESHAP for this industry – a decision recently upheld by a federal appeals court.

While the Appendix C Feasibility Study was directed at the question of lead emission control, the conclusions are based on the Exide facility itself. Whether it is for the control of lead or of arsenic, we describe above the theoretical effect of the WESP being 100% effective for ALL metals and still find the incremental risk improvement at the Exide facility to be only 1.04 in a million. This small incremental risk improvement, mainly from arsenic emission reductions, would still be at extremely high cost. Further, there is insufficient space at the Exide facility to accommodate the WESP system. AQMD statements in a recent document supporting the pending Rule 1420.1 rulemaking suggest that Exide place a WESP at the current location of the facility's storm water pond. That pond cannot simply be filled in and eliminated. The storm water pond is an integral part of the facility's environmental controls and a unit under Department of Toxic Substances Control permitting authority. For further details in this regard, please refer to Exide's November 8, 2013 CEQA comments regarding Proposed Amended Rule 1420.1.

In contrast, rather than mandating WESP control, we explore the specific risk drivers (pollutants and sources) making up the residual risk at the Exide Vernon facility and then consider potential technological and cost-effective alternative measures to further reduce that risk to levels akin to what a WESP could potentially provide.

Control of Toxic Organic Emissions

First, we address the residual risk posed by organic toxic emissions, noted above to comprise about 38% of the residual MEIW risk. In turn, 70% of this toxic organic contribution to the MEIW risk is from the Feed Dryer stack, at about 1.5 in a million risk. The cost to control emissions from a given source is directly proportional in large part to the airflow of the source – handling more flow requires larger devices. In the case of organic pollution control devices, typically thermal oxidizers, operating costs (in fuel) will also increase greatly when handling larger flows. In this case controlling organic emissions from the feed dryer stack is particularly attractive in that it is a relatively small air flow rate (15,000 cfm) contributing 70% of the organic risk.

Beyond the afterburners and inherent reverberatory furnace heat that control toxic organics from the direct furnace process emissions, per the NESHAP for this industry, only one other source that has ever been fitted with toxic organic air pollution control devices, which was for a reverberatory furnace Feed Dryer.

Given this example and the ability to get the most risk reduction from the smallest flow, Exide proposes and commits to the installation of an RTO on the exhaust of its Reverberatory Furnace Feed Dryer. Assuming a nominal 90% expected destruction efficiency, this would reduce facility risk at the MEIW by 1.4 in a million. Order of magnitude estimated capital cost for this unit is \$1 million. Exide expects to be able to have this unit installed in the first quarter of 2015, contingent upon AQMD permitting, procurement, and installation.

Control of Toxic Metal Emissions

As stated above, the WESP technology is not feasible for either lead or arsenic control at the Exide Vernon Plant. [See Appendix C]. Looking beyond WESP toward technologies that are feasible for further improving emissions of toxic metals, Exide notes that the best-controlled facilities in the industry have deployed or are deploying secondary filtration devices downstream of the primary dust collection baghouses in the form of HEPA filters. The degree of emission reduction that can be achieved by HEPA filters on this industry's stack emissions is unclear and expectations vary widely. While HEPA filters are rated by definition to filter 99.97% of particles at a 0.3 micron size, it is not appropriate to assume or estimate that placing a HEPA filter downstream of a fabric filter or cartridge collector will reduce metal emissions by a further 99.97%. This is because some relatively significant fraction of the metal emissions exiting a fabric filter will be in the "condensable" size range, that is, material that passes through the filter in the stack testing apparatus and subsequently caught in the wet impingers in the test train. Material small enough to pass through the stack testing filter is also small enough to pass through a HEPA filter. EPA, for example, found in its analysis of the industry's emission data that "HEPA filters used downstream of a baghouse achieve approximately 20 percent lower outlet concentrations than baghouses alone." [Docket ID No. EPA-HQ-OAR-2011-0344 item 0055, page 5]. The AQMD established a higher range of expectation in its calculation of the expected improvement from installing HEPA filters downstream of the Exide Vernon facility's cartridge collectors. The District estimated that such installation would reduce lead emissions by 70.8% and result in outlet lead concentrations downstream of the HEPA filters of 2.715 microgram per dry standard cubic meter ($\mu\text{g}/\text{dscm}$). [see document "HB3151-25 Excess Emissions" from Case 3151-25, attached as Appendix F to the Feasibility Study in Appendix C] In the case of the remaining arsenic emissions from the Hard Lead stack, preliminary engineering testing conducted on April 19 after the installation of the isolation door found outlet arsenic to be more than 50% in the filterable fraction, consistent with the filterable fraction of lead. To the extent we can expect lead improvement in the 20 to 70% range, these comparisons of filterable fraction composition for arsenic lead us to also expect arsenic improvement in the same range. Based upon that fraction, we expect metals improvement on the order of 50% nominally for stacks fitted with secondary HEPA filters.

This facility has already installed secondary HEPA filters on the MAPCO battery breaker demister (in place for the AB2588 testing and already reflected in the January 2013 HRA), the Feed Dryer stack, the Material Handling Baghouse Stack, and the North and South Torit stacks (none of these improvements reflected in the January 2013 HRA). Exide additionally proposes and commits to installing secondary HEPA filters on all other stacks at its facility, other than the Neptune Scrubber stack which already has the inherent secondary filtration effect of the wet scrubber downstream of its associated baghouses. This would add secondary HEPA filtration to the Hard Lead, Soft Lead, and MAC stacks.

The risk contributions at the MEIW remaining after the isolation door improvement for each of these stacks for which HEPA improvement is not already accounted for in the January 2013 HRA are:

Table 3 MEIW Risks of Metal Emissions from Eight Exide Stacks	
Source	Combined MEIW risk, all metals
Material Handling Stack	5.07E-07
Hard Lead Stack	4.37E-07
Soft Lead Stack	2.51E-07
Dryer Stack	2.01E-07
MAC Baghouse stack	5.88E-07
North Torit Stack	7.92E-08
South Torit Stack	5.77E-08
Total	2.1E-06 or 2.1 in a million

A fifty percent reduction in the metals emissions from these stacks via HEPA filtration would reduce MEIW risk by about 0.7 in a million. Of this improvement, some is from units already installed but not yet tested. The proposal going forward is to install HEPA units on three additional stacks (Hard Lead, Soft Lead, and MAC) each of roughly 100,000 cfm nominal capacity. Based on Exide experience with the installation of the similarly sized units downstream of the Torit cartridge collectors, Exide expects cost on the order of \$350,000 per unit, or \$1.1 million in the aggregate for three.

The effectiveness of the HEPA filters proposed is enhanced by the measures proposed by Exide which will route those source points having the potential to give rise to unfilterable arsenic emissions to and through the wet scrubbing system rather than the baghouses that would be secondarily HEPA-controlled. That is, we have greater assurance that the above-described improvements related to secondary HEPA installation will be achieved because the following source points will be routed to the wet scrubbing system:

Two refining kettles to which arsenic addition will be restricted (AQMD October 24, 2013 letter, Item 3)

Hooding from the top of the blast furnace, which collect emissions potentially escaping from the charge chute. (AQMD October 24, 2013 letter, Item 3)

Hooding from the blast furnace slag tap.

Testing of the Torit systems by AQMD contractor on September 20, 2013 did not detect arsenic emissions and, hence, no arsenic detected in the unfilterable phase. Pressures were positive in BOTH furnaces during this testing. Testing of the Torit systems by Exide's contractor in October and November 2013 only found detectable arsenic emissions during one test run on the South Torit, but all the detected arsenic was in the filterable fraction.

Testing of the Soft Lead stack, August 2013, found no arsenic in the gaseous or unfilterable catch – indicating that unfilterable arsenic is not an issue from this stack. Note that the pressures in the reverberatory furnace were POSITIVE in this testing. Hence, there is no proposal to route any soft lead system hooding to wet scrubbing.

The remaining items routed to the Hard Lead System (the balance of refining kettles and hooding of the lead tap) will not contain unfilterable arsenic. There is no indication that unfilterable arsenic evolved in the blast furnace would migrate downward against the blast tuyere pressure to reach the lead tapping point. The blast furnace lead tapping point does not provide a conduit to the internal furnace atmosphere – it is an “underwell” point such that the opening is always filled with molten metal. In addition, the molten slag layer lies above the molten lead. In tests of separate Hard Lead Ventilation System duct branches in April 2013, no unfilterable arsenic was detected in the tested branch serving the lead tap hood.

Exide will install the secondary HEPA filters on the remaining units by the first quarter of 2015, subject to AQMD permit approval.

Overall Reductions

In further reducing the residual risk remaining after the installation of the isolation door at the MEIW (now estimated at 5.8 in a million), the following reductions are expected from the further incremental controls proposed:

Installation of RTO on Feed Dryer	1.4 in a million reduction
Installation of Secondary HEPAs	0.7 in a million reduction
Total	2.1 in a million reduction

Two important points are to be made regarding this proposed degree of further improvement:

- The expected level of risk remaining after the installation of the isolation door is already below the Rule 1402 Action Risk Levels before implementation of any of these additional measures and their associated further reductions, and
- The level of incremental MEIW risk reduction from the proposed suite of additional measures of 2.1 in a million is better than the result that would be achieved by implementation of a WESP on those same source types as the other facility in this industry in Southern California.

6 Specification of Risk Reduction Measures [(f)(3)(E)]

The basic specifications of the measures proposed for achieving compliance with the Action Risk Levels are as follows:

The blast furnace feed chute isolation door, which is already permitted, installed, and operating, is designed to provide an effective barrier to the passage of blast furnace process gases out through the furnace charge chute when closed. Its system includes an actuator system that drives the door opening and closing in conjunction with passage of the feed skip hoist over the chute to allow charging. This actuation is also fitted with a recorder to log its activity.

Installation of the second furnace process Venturi scrubber APCS will allow for the draft to the two smelting furnaces to be managed independently. The primary design specification for this new system arrangement will be to achieve and maintain a negative internal pressure of at least 0.02 inches of water in each furnace on a 30-minute average basis.

The RTO for control of organic toxic emissions from the feed dryer will be specified to the potential vendors to achieve a destruction efficiency of the key risk-driving organic emittents (benzene, 1,3-butadiene, and PCB's) of at least 90 percent. Exide and ENVIRON expect that this level of performance will be achieved by an RTO having basic specifications of residence time in the 0.3 to 1.3 seconds range with temperatures between 1400 and 1500 degrees F. Details will be refined through vendor interaction to seek the 90 percent destruction target.

The secondary HEPA filters to be installed will meet the standard HEPA specification of 99.97% efficiency at 0.3 microns.

More detailed specifications were provided with the air permit application for the feed chute isolation door submitted on March 7, 2013 and approved by AQMD on March 28, 2013. Additional detail and specification of the proposed RTO and secondary HEPA filtration units will similarly be provided with the air permit applications seeking approval for their installation.

Design activities for the rearrangement of the main process APC systems to add the additional wet scrubber and the blast furnace charge hood RTO will result in additional specification development which will be passed on as available and comprehensively summarized in the air permit applications for their installation.

7 Schedule [(f)(3)(F)]

Exide believes that the installation of the blast furnace feed chute Isolation Door has already been effective to a degree sufficient to bring the health risks below the Rule 1402 Action Risk Levels. Exide is proceeding with design of the RTO and secondary HEPA installations and will be submitting permit applications for their construction in an expedited fashion.

Exide understands the District's request for a schedule reflecting completion dates within a time window after permits are issued. While Exide respects the District's role and acknowledges that permit applications require time and effort to review, based on the time that the District has had to review the HEPA permit applications submitted last November (Exide has promptly responded to all District information requests regarding these applications but Exide still has no permits to construct), Exide is legitimately concerned that the District may not issue permits in a timely enough manner to allow Exide to achieve its aggressive project schedule. In order to satisfy all District Rules, Exide is targeting completion of these projects in the first quarter of 2015. Because of their complexity and in order to ensure safe and effective installation, all of these projects need to be well coordinated and many must be scheduled during planned facility shutdowns. Exide will continue to work diligently with the District on permitting issues, and Exide refines the schedule previously set forth in Section 7 of the previously approved March 2014 RRP:

Details of the scheduled activities are below. Certain dates and projects are subject to reasonable modification for design refinement, and dates may be delayed by contingencies outside Exide's reasonable control. Where applicable, the procurement and installation cycle durations are given to indicate the time windows after an assumed SCAQMD permit issuance in mid-October 2014 by which installation can be completed.

Submit air permit applications for secondary HEPA on Hard Lead and Soft Lead baghouses	Submitted 11/14/13
Submit air permit applications for secondary HEPA on MAC baghouse	Submitted 11/14/13
Submit air permit application for RTO on Feed Dryer	Submitted 1/7/14
Submit air permit application for change of reverb feed system	Submitted 1/7/14
Complete design of main APCS scrubbing system addition, afterburner modification, and rerouting of various hard lead system hoods to that new scrubbing system	3/28/14
Submit air permit applications for all aspects of this fundamental APCS rearrangement	4/10/14
Install charge level and temperature sensors in blast furnace	1/1/15

- Install screw feeding system on reverb furnace** **1/1/15**
- Complete installation of secondary HEPA on Hard Lead and Soft Lead baghouses** **4/15/15**
- (assumes issuance of SCAQMD permit by October 15, 2014)
- Complete installation of secondary HEPA on MAC baghouse** **4/15/15**
- Delivery of unit duration 11 weeks from permit issuance
 - 1 week installation duration
 - Minimum total elapsed from presumed 10/15/14 permit issuance = 1/15/15
- Complete installation of RTO on Feed Dryer** **4/15/15**
- Delivery of unit duration 14 weeks from permit issuance
 - 2 week installation duration
 - Minimum total elapsed from presumed 10/15/14 permit issuance = 2/15/15
- Complete installation of new APCS scrubbing system, RTO modification, and rerouting of hard lead system hoods and refining kettles to repurposed baghouse** **4/15/15**
- Delivery of new scrubber 18 weeks from permit issuance
 - 3 week installation duration
 - Minimum total elapsed from presumed 10/15/14 permit issuance = 3/15/15

Exide is working to expedite all activities in this schedule. Procurement and fabrication of custom air pollution control equipment generally governs the timing.

Per the March 1, 2013 letter approving the January 2013 HRA, Exide is not eligible for time extension, and Section (f)(3)(G) is, therefore, not applicable.

8 Estimation of Post-Implementation Risk [(f)(3)(H)]

Exide has projected the facility-wide risk that would remain after the implementation of all the above-described measures: the blast feed chute isolation door, feed dryer RTO, and secondary HEPA filtration on all sources other than the Neptune Scrubber exhaust, and expansion of the main process APCS scrubbing system. This assessment is presented in Appendix D. A summary of the key results metrics are as follows:

Maximum Exposed Individual Worker cancer risk -	3.7 in one million
Maximum Exposed Individual Resident cancer risk -	1.2 in one million
Cancer Burden -	0.005
Maximum Chronic Hazard Index, Worker -	0.4
Maximum Chronic Hazard Index, Resident -	0.04
Maximum Acute Hazard Index, Worker -	0.1
Maximum Acute Hazard Index, Resident -	0.008

Following installation of all prescribed measures described in this RRP, Exide would conduct testing simultaneously for metals and Method TO-15 organics (inclusive of at least benzene and 1,3-butadiene) on five stacks (hard lead, soft lead, process scrubber stack (both scrubber exhausts combined), North Torit, and South Torit) to verify final risks (AQMD October 24, 2013 letter, Item 7).

Appendix A

May 2, 2013 Memorandum on Preliminary Testing

MEMORANDUM

TO: Exide Technologies

FROM: Russell S. Kemp, PE
Principal

DATE: May 2, 2013

RE: Assessment of Effectiveness of Blast Furnace Isolation Door
Vernon, California, Facility

As requested, we have conducted an evaluation of the effectiveness of the blast furnace charge chute isolation door installed at the Exide Technologies facility in Vernon, California, in terms of reducing emissions from the Hard Lead Ventilation System stack and reducing overall calculated facility risk. Based upon the details and analysis provided below, we conclude that the isolation door has been effective in its intended purpose and has resulted in reducing the overall calculated facility risks to below the Action Risk Levels specified in South Coast Air Quality Management District (AQMD) Rule 1402, which implements the AB2588 air toxics program. This conclusion is based upon preliminary engineering test data collected on April 9, 10, 18, and 19, 2013 subsequent to the installation of an isolation door on the blast furnace charge chute. These test data have been shared with the AQMD and are subject to confirmation through further detailed emission testing specified in the air permit for the installation of the isolation door issued on March 28, 2013. It is our opinion that these confirmatory official tests will confirm the findings and conclusions presented in this memorandum.

Background

On March 1, 2013, AQMD issued its approval of the AB2588 Health Risk Assessment (HRA) prepared by ENVIRON International Corporation (ENVIRON) and submitted in January 2013. That HRA was prepared in accordance with protocols approved by AQMD with DTSC in a consultative role and is based upon emissions data collected in testing conducted in 2010 and 2012. As summarized in the AQMD letter of March 1, 2013 the calculated health risks exceeded the Public Notice thresholds and Action Risk Levels in AQMD Rule 1402 which implements AB2588.

The primary driver of risk in this HRA was the impact of arsenic emitted from the facility's Hard Lead Ventilation System stack. This ventilation system is comprised of ductwork serving a number of hoods intended to collect metal-bearing dust at points of potential worker exposure around the facility's blast furnace and the refining kettles associated with that furnace. The air collected at these hoods is filtered in a baghouse to remove metals prior to discharge to the atmosphere. Through evaluations performed in 2011 and 2012 it was determined that blast furnace process exhaust was making its way into some of the hooding around the furnace charge chute rather than being confined to its intended path through the furnace afterburner, blast furnace baghouse, and wet scrubber. Operational improvements implemented in 2012 were successful in reducing arsenic emissions from the Hard Lead Ventilation System stack by approximately 70% from that measured in 2010. The HRA submitted in January 2013 and approved on March 1, 2013 was based upon the average of the 2010 and 2012 test results for this stack.

In order to more reliably preclude the entry of blast furnace process exhaust into the Hard Lead Ventilation System, Exide designed an isolation door system for the charge chute which would

provide a more direct and positive barrier for containing the process exhaust gases in the furnace as desired. The AQMD approved a permit application for the installation of this isolation door on an expedited basis on March 28, 2013 and the installation of the door was completed on April 4, 2013.

Testing

ENVIRON developed a testing program for the evaluation of the effectiveness of the isolation door which was shared with AQMD. Emissions testing on the Hard Lead Ventilation System stack commenced on April 9, 2013 with ENVIRON personnel in attendance for all testing. As testing progressed over subsequent days, AQMD personnel observed some of the tests and splits of the physical samples collected by Almega were delivered to the AQMD's laboratory. Preliminary results from the testing were transmitted to AQMD by Almega simultaneously with delivery to ENVIRON and Exide.

Three 2-hour duration tests were conducted on April 9, 2013. At this stage, the isolation door was newly installed and still in a "debugging" mode of operation. Notably, the mechanism experienced jams resulting in leakage, especially during the third run. A single 4-hour duration test was conducted on April 10, 2013. Operation of the door was more steady during this run.

Subsequent to the testing on April 9 and 10, the facility made further improvements to the door mechanism. Four-hour tests on the Hard Lead Ventilation System exhaust were conducted on April 18 and 19. During the testing on the 18th, arsenic was added directly to one of the refining kettles served by the Hard Lead Ventilation System to assess the potential for that activity to affect emissions.

The preliminary results from these four days of testing are presented in **Table 1**. In that Table we also present, for reference, the prior results for arsenic, benzene, and 1,3-butadiene from this stack from 2010 and 2012 which formed the basis of the approved January 2013 HRA. We also compare the emission results obtained since installation of the isolation door with these prior data. As noted above, the reduction in arsenic emissions achieved by operational adjustments between 2010 and 2012 was 70%. The recent data indicate a further reduction beyond the 2012 improvement on the order of 98%. Comparable levels of improvement are also seen in the emissions of benzene and 1,3-butadiene, both of which would be associated with furnace process gases, further demonstrating the effectiveness of the isolation door in minimizing the escape of process gases into the Hard Lead Ventilation System.

Risk

To evaluate the impact of these emissions improvements on calculated risk, we substituted these new emission data for arsenic, benzene, and 1,3-butadiene from the Hard Lead Ventilation System stack into the same HRA protocol and calculation approach as used in the HRA approved on March 1, 2013. That is, we reassessed facility-wide risk including all the other stacks and pollutant data just as they were in the January 2013 HRA with the only adjustment being these alternate emission data from the Hard Lead Ventilation System stack. Results of these analyses are also presented in **Table 1**.

Based upon the April 10, 2013 emission data, highlighted in pink in Table 1, calculated risks are all below the Rule 1402 Action Risk Levels. Residential and sensitive receptor (e.g., schools) cancer risks are all less than 5 in a million. The maximum worker cancer risk is only slightly above 10 in a million.

As stated above, improvements were made to the isolation door system between the testing conducted on April 10 and April 18. The testing conducted on April 18 also had the diagnostic purpose of assessing the potential remaining influence from the addition of arsenic into a refining kettle to adjust alloy specification – an activity typically performed on only a handful of kettle batches each week. Arsenic emissions from the Hard Lead Ventilation System stack were, indeed, higher on April 18 than on the 10th or 19th, but still 98% less than the arsenic emission rate used in the January 2013 HRA. In addition, the 1,3-butadiene emission rates on the 18th and 19th were a factor of ten lower than those measured on April 10, indicating that the door function was improved between the 10th and 18th. Arsenic emissions on the 19th were also substantially lower than those seen during the first week of testing on the 9th and 10th.

A second set of risk calculations was run using the average rates from April 18th and 19th as inputs. This combination is believed to be a conservative projection of the emissions that would be expected during the official testing series which will involve three 8-hour tests. These risk calculations, again simply substituting in data in Table 1 for the Hard Lead Ventilation System stack with all other inputs as they were in the approved January 2013 HRA, indicate essentially the same results as the scenario from the April 10 data. That is, any elevation in arsenic emissions resulting from the occasional addition of arsenic to a refining kettle for alloy adjustment was offset by the further reductions in 1,3-butadiene emissions achieved by the improvements to the isolation door mechanism after April 10.

Results of the Hard Lead Ventilation System stack testing reflect that only one receptor has a calculated cancer risk above 10 in a million and that is the same receptor that had a calculated cancer risk of 156 in a million in the January 2013 HRA.

Most significantly, all these calculated risks based on preliminary emissions testing since the installation of the isolation door meet the risk reduction Action Risk Levels specified in AQMD Rule 1402 of 25 in-a-million cancer risk, hazard index of 3, and cancer burden of 0.5 by a wide margin. It is our opinion that based on these preliminary results, no further risk reduction will be necessary to satisfy Rule 1402.

Summary and Next Steps

It is our understanding that AQMD is reviewing these preliminary test data. In addition, as noted above, the air permit issued on March 28, 2013 calls for triplicate emissions tests conducted simultaneously on the Hard Lead Ventilation System stack and the Neptune Scrubber stack (through which the blast furnace process gases exhaust) to be conducted before August 2, 2013. Given the breadth of the preliminary engineering testing conducted thus far, we believe that the emissions to be measured during these pending tests will be less than the average rates from April 18th and 19th. That is, it is our expectation that the pending official permit-required testing will confirm the analysis contained herein, likely with emissions and risks below those presented.

Table 1 Comparison of Hard Lead System Test Data

Green = ND value entered at detection limit

INITIAL THREE RUNS, 09 April 2013

	2008 lb/hr	2010 lb/hr	2012 lb/hr	%Reduction 2012 v. 2010	2010-2012 avg. used in HRA	4/9/13 Run 1	4/9/13 Run 2	4/9/13 Run 3	4/9/2013 Average	4/9/2013 avg %Reduction from 2010	4/9/2013 avg %Reduction from 2012	4/9/2013 avg %Reduction from HRA
Arsenic	8.50E-04	0.0759	0.0210	72%	0.0486	0.00032	0.00063	0.0031	0.00135	98.2%	93.6%	97.2%
Benzene		1.41	0.531	62%	0.97	0.011	0.0185	0.045	0.02483	98.2%	95.3%	97.4%
1,3-Butadiene		0.345	0.15	57%	0.248	0.0012	0.0017	0.013	0.00530	98.5%	96.5%	97.9%

DETINNING TREATMENT, 10 April 2013

	2008 lb/hr	2010 lb/hr	2012 lb/hr	%Reduction 2012 v. 2010	2010-2012 avg. used in HRA	OUTLET 4/10/2013 lb/hr	4/10/2013 %Reduction from 2010	4/10/2013 %Reduction from 2012	4/10/2013 %Reduction from HRA
Arsenic	8.50E-04	0.0759	0.0210	72%	0.0486	4.00E-04	99.5%	98.1%	99.2%
Benzene		1.41	0.531	62%	0.97	0.045	96.8%	91.5%	95.4%
1,3-Butadiene		0.345	0.15	57%	0.248	0.019	94.5%	87.3%	92.3%

Substituted in for Hard Lead stack with all other inputs same as January 2013 HRA

Purple font indicates value above Notification Threshold
Red font indicates value above Risk Reduction Action Level

MEIW max Worker Cancer Risk	1.07E-05	at receptor 1005
MEIW max Worker Chronic Hazard Index	1.23	at receptor 1005
Acute Hazard Index Max Worker	0.438	at receptor 80
MEIR max Resident Cancer Risk	3.48E-06	at receptor 1016
MEIR max Resident Chronic Hazard Index	0.128	at receptor 1016
Max School Cancer Risk	2.59E-06	Salazar Park Head Start
Max School Chronic Hazard Index	0.1	Salazar Park Head Start
Cancer Burden	0.315	

ARSENIC ADDITION IN REFINERY, 18 April 2013

	2008 lb/hr	2010 lb/hr	2012 lb/hr	%Reduction 2012 v. 2010	2010-2012 avg. used in HRA	OUTLET 4/18/2013 lb/hr	4/18/2013 %Reduction from 2010	4/18/2013 %Reduction from 2012	4/18/2013 %Reduction from HRA
Arsenic	8.50E-04	0.0759	0.0210	72%	0.0486	1.16E-03	98.5%	94.5%	97.6%
Benzene		1.41	0.531	62%	0.97	0.0385	97.3%	92.7%	96.0%
1,3-Butadiene		0.345	0.15	57%	0.248	0.0017	99.5%	98.9%	99.3%

TYPICAL OPERATIONS, 19 April 2013

	2008 lb/hr	2010 lb/hr	2012 lb/hr	%Reduction 2012 v. 2010	2010-2012 avg. used in HRA	OUTLET 4/19/2013 lb/hr	4/19/2013 %Reduction from 2010	4/19/2013 %Reduction from 2012	4/19/2013 %Reduction from HRA
Arsenic	8.50E-04	0.0759	0.0210	72%	0.0486	2.10E-04	99.7%	99.0%	99.6%
Benzene		1.41	0.531	62%	0.97	0.0073	99.5%	98.6%	99.2%
1,3-Butadiene		0.345	0.15	57%	0.248	0.0012	99.7%	99.2%	99.5%

Average of results from 18 and 19 April

	2008 lb/hr	2010 lb/hr	2012 lb/hr	%Reduction 2012 v. 2010	2010-2012 avg. used in HRA	OUTLET 18 & 19 avg lb/hr	4/19/2013 %Reduction from 2010	4/19/2013 %Reduction from 2012	4/19/2013 %Reduction from HRA
Arsenic	8.50E-04	0.0759	0.0210	72%	0.0486	6.85E-04	99.1%	96.7%	98.6%
Benzene		1.41	0.531	62%	0.97	0.0229	98.4%	95.7%	97.6%
1,3-Butadiene		0.345	0.15	57%	0.248	0.00145	99.6%	99.0%	99.4%

Substituted in for Hard Lead stack with all other inputs same as January 2013 HRA

Average of 4/18 and 4/19	
Arsenic	6.85E-04
Benzene	2.29E-02
1,3-Butadiene	1.45E-03

Purple font indicates value above Notification Threshold
Red font indicates value above Risk Reduction Action Level

MEIW max Worker Cancer Risk	1.11E-05	at receptor 1005
MEIW max Worker Chronic Hazard Index	1.59	at receptor 1005
Acute Hazard Index Max Worker	0.438	at receptor 80
MEIR max Resident Cancer Risk	3.50E-06	at receptor 1016
MEIR max Resident Chronic Hazard Index	0.144	at receptor 1016
Max School Cancer Risk	2.44E-06	Salazar Park Head Start
Max School Chronic Hazard Index	0.106	Salazar Park Head Start
Cancer Burden	0.322	

Appendix B

Updated Emissions Inventory and Health Risk Assessment

Appendix B

Updated Health Risk Assessment

ENVIRON prepared this updated health risk assessment (HRA) to provide risk metrics reflecting the effects of the isolation door installed on the charge chute to Exide's blast furnace. The door was to minimize the potential for blast furnace process exhaust gases to be drawn into the hooding for the Hard Lead Ventilation System (Hard Lead). This updated HRA used the source test results obtained from the Hard Lead, the Soft Lead Ventilation System (Soft Lead), and the Neptune Scrubber (Neptune) stacks on various days in August and September 2013. The source tests were conducted by Almega Environmental and Technical Service (Almega) for Exide. This updated HRA also includes the source test results obtained from the North and South Torits stacks on September 20, 2013. The source tests were conducted by Almega for AQMD.

The toxic air contaminant (TAC) emissions used in this update are described in Section B.1 below. ENVIRON used the same air modeling and risk assessment methodologies as those in the approved January 2013 HRA. A brief summary of our methodologies is included in Section B.2 below. Section B.3 describes the health risk results. The results from this HRA showed that the isolation door was effective in reducing the emissions.

B.1 Updated TAC Emissions

The TAC emissions from the source tests, which were used to calculate the health risk metrics, are summarized in Tables B-1 through B-4 for Hard Lead, Soft Lead, Neptune, and the North and South Torits. The changes in the emission rates compared with those in the approved January 2013 HRA are also presented in Tables B-1 through B-4, expressed as reduction and percent reduction.

For the metals that were below the laboratory's reporting limits in the August/September 2013 source tests, and instead of using "zero" as the emission rate, ENVIRON used the following hierarchy to select a non-zero emission rate:

- 1) If the emission rate in the January 2013 HRA is lower than the reporting limit in the August/September 2013 source test, we used the value in the January 2013 HRA;
- 2) If a particular metal was not detected in any of the source tests, we used the lowest laboratory reporting limit as the emission rate.

For the organics that were below the laboratory's reporting limits in the August/September 2013 source tests, zero emissions were used if the organic compound was also below the reporting limits in the 2010 and 2012 source tests. This approach is consistent with the CARB Emission Inventory Criteria and Guidelines². If the organics were reported with non-zero emissions in the approved January 2013 HRA, the lower of the reporting limit in the August/September 2013 test and the reported value in the approved January 2013 HRA was used.

² State of California Air Resources Board (CARB), 2007: Emission Inventory Criteria and Guidelines for the Air Toxics "Hot Sports" Program. August.

An updated facility-wide TAC emission inventory is provided in Table B-5, which incorporates the August and September 2013 source test results. Entrained paved road dust emissions were revised slightly by using the k factor for PM10 instead of PM30 (AP-42 Section 13.2.1). Air toxic emissions not mentioned above remain the same as those in the approved January 2013 HRA.

B.2 Modeling and Risk Assessment Methods

This updated HRA repeated the risk calculations in the approved January 2013 HRA. Emission sources included all nine stacks of the manufacturing processes and two stacks for the natural gas water heaters as point sources, as well as the area sources representing the onsite entrained road dust. ENVIRON updated the emission data in the approved January 2013 HRA with those listed in Tables B-1 through B-4.

ENVIRON used the same XOQ files that were generated for the approved January 2013 HRA in this updated HRA. The regulatory default options were used to generate the XOQ values using Breeze AERMOD version 7.6 (EPA AERMOD version 12060). The source parameters were based on the source test reports that were used in the approved January 2013 HRA. The receptor grid covers a 3,600-square-kilometer area surrounding the facility, and census block receptors were identified within this area using United States Census Bureau data. ENVIRON obtained the meteorological data for the Central Los Angeles station from the South Coast Air Quality Management District (SCAQMD)'s website for the years of 2006 and 2007. The elevations for the sources and receptors were extracted from the National Elevation Datasets (NED) on the United States Geological Survey's (USGS) website. The modeling used the Universal Transverse Mercator (UTM) system of coordinates and the World Geodetic System 1984 (WGS84) spheroid.

ENVIRON used HARP (version 1.4f) to calculate the health risks, which is the same version that ENVIRON used for the approved January 2013 HRA and the currently available version on the California Air Resources Board (CARB)'s website. An updated HARP Health Value Database was released by CARB on August 1, 2013. This new database contains updated health values for 1,3-butadiene adopted by OEHHA and was used in this updated HRA. The newly adopted values are: 2 $\mu\text{g}/\text{m}^3$ (chronic REL) and 660 $\mu\text{g}/\text{m}^3$ (acute REL), compared to the 20 $\mu\text{g}/\text{m}^3$ (chronic REL) and no acute REL previously.

ENVIRON used the same risk calculation parameters as those in the approved January 2013 HRA, which followed the OEHHA Air Toxics Hot Spots Program Guidance Manual for Preparation of Health Risk Assessment and the SCAQMD's Supplemental Guidelines for Preparing Risk Assessments for the Air Toxics "Hot Spots" Information and Assessment Act.

B.3 Risk Estimates

The cancer risk at the Maximally Exposed Individual Worker (MEIW) is estimated to be 5.8 in a million or 5.8E-6 (vs. 156 in a million prior to the isolation door installation). The MEIW is at Receptor 1005 (389900, 3763600) and is located in the railyard north of the facility (see Figure B-1). The cancer risk at the Maximally Exposed Individual Resident (MEIR) is estimated to be 2.1 in a million or 2.1E-6 (vs. 22 in a million prior to the isolation door installation). The MEIR is at Receptor 1016 (389900, 3764700) and is located in the residential area north of the facility

(see Figure B-2). Both maximum cancer risks are below the SCAQMD Rule 1402 Action Level of 25 in a million and public notification threshold of 10 in a million.

The cancer burden is estimated to be 0.05, which is below the SCAQMD Rule 1402 Action Level of 0.5. The cancer burden in the January 2013 HRA was 10.

The maximum Chronic Hazard Index (CHI) for the worker scenario is estimated to be 0.5 (vs. 63 previously) and is at the same location as the MEIW (see Figure B-1). The maximum CHI for the residential scenario is estimated to be 0.05 (vs. 2.9 previously) and at the same location as the MEIR (see Figure B-2). Both CHIs are below the SCAQMD Rule 1402 Action Level of 3.0 and public notification threshold of 1.0.

The maximum Acute Hazard Index (AHI) [i.e. Point of Maximum Impact (PMI)] is estimated to be 0.1 (vs. 3.8 previously). It is at Receptor 80 (389659, 3763479) and is located on the western fence line near the railway track (see Figure B-1). The maximum AHI for the residential scenario is estimated to be 0.009 (vs. 0.2 previously). It is at the same location as the cancer risk MEIR (see Figure B-2). Both AHIs are below the SCAQMD Rule 1402 Action Level of 3.0 and public notification threshold of 1.0.

All electronic files, including emissions, modeling, and health risk assessment, are included in the CD-ROM in Appendix E of the RRP.

Tables

Table B-1 Summary of Hard Lead TAC Emissions

Exide Technologies
 Vernon, California

Chemical	CAS	AB2588 Emission Rate - Aug/Sep2013 Tests ¹	Emission Rate Used for Health Metric Calculation ²		Emission Rate in Jan 2013 HRA	Reduction (Jan2013 – Aug/Sep2013)	Percent Reduction/ (Reduction/ Jan2013)
		lb/hr	lb/hr	Data Source ³	lb/hr	lb/hr	
Aluminum	7429905	2.36E-04	2.36E-04	Aug/Sep 2013 test	0	-2.36E-04	--
Antimony	7440360	1.92E-05	1.92E-05	Aug/Sep 2013 test	2.14E-05	2.15E-06	10%
Arsenic	7440382	9.99E-05	9.99E-05	Aug/Sep 2013 test	4.86E-02	4.85E-02	100%
Barium	7440393	1.15E-05	1.15E-05	Aug/Sep 2013 test	1.90E-05	7.50E-06	39%
Beryllium	7440417	0	1.84E-05	2010 test reporting limit	0	0	--
Cadmium	7440439	0	5.95E-05	Jan 2013 HRA	5.95E-05	5.95E-05	100%
Chromium	7440473	6.23E-06	6.23E-06	Aug/Sep 2013 test	2.23E-05	1.61E-05	72%
Cobalt	7440484	0	1.47E-05	Aug/Sep 2013 test reporting limit	4.43E-05	4.43E-05	100%
Copper	7440508	1.15E-04	1.15E-04	Aug/Sep 2013 test	3.43E-05	-8.07E-05	-235%
Lead	7439921	2.77E-03	2.77E-03	Aug/Sep 2013 test	1.41E-03	-1.36E-03	-96%
Manganese	7439965	1.93E-05	1.93E-05	Aug/Sep 2013 test	1.29E-05	-6.40E-06	-50%
Mercury	7439976	8.05E-06	8.05E-06	Aug/Sep 2013 test	2.18E-04	2.09E-04	96%
Nickel	7440020	1.31E-05	1.31E-05	Aug/Sep 2013 test	9.47E-05	8.16E-05	86%
Phosphorus	7723140	8.55E-05	8.55E-05	Aug/Sep 2013 test	3.08E-04	2.23E-04	72%
Selenium	7782492	3.05E-05	3.05E-05	Aug/Sep 2013 test	3.55E-06	-2.70E-05	-759%
Silver	7440224	0	6.72E-06	2012 test reporting limit	0	0	--
Thallium	7440280	0	6.72E-06	2012 test reporting limit	0	0	--
Vanadium	7440622	0	2.12E-06	Jan 2013 HRA	2.12E-06	2.12E-06	100%
Zinc	7440666	3.78E-04	3.78E-04	Aug/Sep 2013 test	2.11E-04	-1.67E-04	-79%
Formaldehyde	50000	7.15E-03	7.15E-03	Aug/Sep 2013 test	2.36E-02	1.64E-02	70%
Acetaldehyde	75070	9.05E-03	9.05E-03	Aug/Sep 2013 test	2.88E-02	1.98E-02	69%
Naphthalene	91203	5.28E-03	5.28E-03	Aug/Sep 2013 test	8.75E-02	8.22E-02	94%
2-Methylnaphthalene	91576	7.25E-04	7.25E-04	Aug/Sep 2013 test	1.06E-02	9.90E-03	93%
Acenaphthylene	208968	3.75E-04	3.75E-04	Aug/Sep 2013 test	8.34E-03	7.97E-03	96%
Acenaphthene	83329	6.23E-05	6.23E-05	Aug/Sep 2013 test	5.47E-04	4.85E-04	89%
Fluorene	86737	2.28E-04	2.28E-04	Aug/Sep 2013 test	2.65E-03	2.42E-03	91%
Phenanthrene	85018	1.73E-03	1.73E-03	Aug/Sep 2013 test	1.09E-02	9.15E-03	84%
Anthracene	120127	1.21E-04	1.21E-04	Aug/Sep 2013 test	8.90E-04	7.69E-04	86%
Fluoranthene	206440	2.41E-04	2.41E-04	Aug/Sep 2013 test	1.06E-03	8.19E-04	77%
Pyrene	129000	1.50E-04	1.50E-04	Aug/Sep 2013 test	3.78E-04	2.28E-04	60%
Benz(a)anthracene	56553	1.55E-05	1.55E-05	Aug/Sep 2013 test	1.56E-05	5.00E-08	0%
Chrysene	218019	6.17E-05	6.17E-05	Aug/Sep 2013 test	5.72E-05	-4.50E-06	-8%
Benzo(b)fluoranthene	205992	2.66E-06	2.66E-06	Aug/Sep 2013 test	1.92E-06	-7.40E-07	-39%
Benzo(k)fluoranthene	207089	5.92E-07	5.92E-07	Aug/Sep 2013 test	9.57E-07	3.65E-07	38%
Benzo(e)pyrene	192972	1.11E-06	1.11E-06	Aug/Sep 2013 test	8.79E-07	-2.31E-07	-26%
Benzo(a)pyrene	50328	0	1.62E-07	Jan 2013 HRA	1.62E-07	1.62E-07	100%
Perylene	198550	0	0	Organic not detected in all tests	0	0	--
Indeno(1,2,3-cd)pyrene	193395	0	1.39E-07	Jan 2013 HRA	1.39E-07	1.39E-07	100%
Dibenz(a,h)anthracene	53703	0	0	Organic not detected in all tests	0	0	--
Benzo(ghi)perylene	191242	2.94E-07	2.94E-07	Aug/Sep 2013 test	0	-2.94E-07	--
TEQ (Min) as 2,3,7,8-TCDD	1086	2.30E-10	2.30E-10	Aug/Sep 2013 test	2.62E-11	-2.04E-10	-778%
Total PCBs	1336363	1.78E-04	1.78E-04	Aug/Sep 2013 test	2.76E-04	9.80E-05	36%
Chromium VI	18540299	5.82E-06	5.82E-06	Aug/Sep 2013 test	3.65E-06	-2.17E-06	-59%
Benzene	71432	5.00E-02	5.00E-02	Aug/Sep 2013 test	9.70E-01	9.20E-01	95%
Benzyl Chloride	100447	0	0	Organic not detected in all tests	0	0	--
Bromodichloromethane	75274	0	0	Organic not detected in all tests	0	0	--
Bromoform	75252	0	0	Organic not detected in all tests	0	0	--
Bromomethane	74839	0	7.12E-04	August 2013 test reporting limit	5.21E-03	5.21E-03	100%
1,3-Butadiene	106990	8.79E-03	8.79E-03	Aug/Sep 2013 test	2.48E-01	2.39E-01	96%
2-Butanone	78933	3.14E-03	3.14E-03	Aug/Sep 2013 test	4.55E-03	1.41E-03	31%
Carbon Disulfide	75150	8.25E-03	8.25E-03	Aug/Sep 2013 test	1.18E-01	1.10E-01	93%
Carbon Tetrachloride	56235	0	0	Organic not detected in all tests	0	0	--
Chlorobenzene	108907	0	5.55E-04	Jan 2013 HRA	5.55E-04	5.55E-04	100%
Chloroethane	75003	0	4.84E-04	August 2013 test reporting limit	1.19E-03	1.19E-03	100%
Chloroform	67663	0	0	Organic not detected in all tests	0	0	--
Chloromethane	74873	1.57E-03	1.57E-03	Aug/Sep 2013 test	1.23E-02	1.07E-02	87%
Dibromochloromethane	124481	0	0	Organic not detected in all tests	0	0	--
1,1-Dichloroethane	75343	0	0	Organic not detected in all tests	0	0	--
1,1-Dichloroethene	75354	0	0	Organic not detected in all tests	0	0	--
1,2-Dibromoethane	106934	0	0	Organic not detected in all tests	0	0	--

Table B-1 Summary of Hard Lead TAC Emissions

Exide Technologies
Vernon, California

Chemical	CAS	AB2588 Emission Rate - Aug/Sep2013 Tests ¹	Emission Rate Used for Health Metric Calculation ²		Emission Rate in Jan 2013 HRA	Reduction (Jan2013 – Aug/Sep2013)	Percent Reduction (Reduction/ Jan2013)
		lb/hr	lb/hr	Data Source ³	lb/hr	lb/hr	
1,2-Dichlorobenzene	95501	0	0	Organic not detected in all tests	0	0	--
1,2-Dichloroethane	107062	0	0	Organic not detected in all tests	0	0	--
1,2-Dichloropropane	78875	0	0	Organic not detected in all tests	0	0	--
1,3-Dichlorobenzene	541731	0	0	Organic not detected in all tests	0	0	--
1,4-Dichlorobenzene	106467	0	0	Organic not detected in all tests	0	0	--
1,4-Dioxane	123911	0	0	Organic not detected in all tests	0	0	--
Ethylbenzene	100414	4.98E-03	4.98E-03	Aug/Sep 2013 test	9.44E-02	8.94E-02	95%
Hexachloro-1,3-Butadiene	87683	0	0	Organic not detected in all tests	0	0	--
MTBE	1634044	0	0	Organic not detected in all tests	0	0	--
Methylene Chloride	75092	0	0	Organic not detected in all tests	0	0	--
4-Methyl-2-Pentanone	108101	0	0	Organic not detected in all tests	0	0	--
Styrene	100425	2.03E-02	2.03E-02	Aug/Sep 2013 test	1.03E+00	1.01E+00	98%
Tetrachloroethene	127184	0	0	Organic not detected in all tests	0	0	--
Toluene	108883	2.34E-02	2.34E-02	Aug/Sep 2013 test	2.96E-01	2.73E-01	92%
Trichloroethene	79016	0	8.70E-04	Jan 2013 HRA	8.70E-04	8.70E-04	100%
Trichlorofluoromethane	75694	0	0	Organic not detected in all tests	0	0	--
1,1,2-Trichloro-1,2,2-Trifluoroethane	76131	0	0	Organic not detected in all tests	0	0	--
1,1,1-Trichloroethane	71556	0	0	Organic not detected in all tests	0	0	--
1,1,2-Trichloroethane	79005	0	0	Organic not detected in all tests	0	0	--
1,1,2,2-Tetrachloroethane	79345	0	0	Organic not detected in all tests	0	0	--
1,2,4-Trimethylbenzene	95636	3.30E-03	3.30E-03	Aug/Sep 2013 test	5.00E-03	1.70E-03	34%
1,2,4-Trichlorobenzene	120821	0	0	Organic not detected in all tests	0	0	--
Vinyl Acetate	108054	1.89E-03	1.89E-03	Aug/Sep 2013 test	2.37E-03	4.75E-04	20%
Vinyl Chloride	75014	0	0	Organic not detected in all tests	0	0	--

P:\E\Exide\HRA 2012 UPDATE\RRP_Revision_Nov2013\for HARP-Nov2013-RRP-current.xlsx\TB1_HL

Notes:

¹ The table lists the emission rates provided by Almega for the tests in August and September 2013. The values follow the CARB guidance for AB2588 emission inventory. Final laboratory reports have not been issued at the time of this report.

² ENVIRON followed the following hierarchy to select the values for the non-detect chemicals:

Metals: 1) used the value in Jan 2013 HRA, if the value in the Jan 2013 HRA is lower than the reporting limit in the Aug/Sep 2013 source tests; 2) otherwise, used the lowest laboratory reporting limit.

Organics: 1) used zero if the it was also below the reporting limits in the 2010 and 2012 source tests; 2) otherwise, use the lower value between the reporting limit of the August/September 2013 tests and the reported value in the Jan 2013 HRA

³ References:

Aug/Sept 2013 test - See note 1

2010 test - Almega. 2010. AB2588 Emissions Testing at the Exide Technologies, Vernon Facility, Hard Lead Refining System. Report #: 9015 – Hard Lead. May 11

2012 test - Almega. 2012. AB2588 Emissions Testing at the Exide Technologies, Vernon Facility, Hard Lead Refining System. Report #: 9255 – Hard Lead. August 10.

Jan 2013 HRA - ENVIRON. 2013. Revised AB2588 Health Risk Assessment. January

Table B-2 Summary of Soft Lead TAC Emissions

Exide Technologies
Vernon, California

Chemical	CAS	AB2588 Emission Rate - Aug/Sep2013 Tests ¹		Emission Rate Used for Health Metric Calculation ²		Emission Rate in Jan 2013 HRA	Reduction (Jan2013 - Aug/Sep2013)		Reduction Percentage (Reduction/Jan2013)
		lb/hr	lb/hr	Data Source ³			lb/hr	lb/hr	
Aluminum	7429905	1.53E-04	1.53E-04	Aug/Sep 2013 test		3.62E-03	3.47E-03	96%	
Antimony	7440360	4.84E-05	4.84E-05	Aug/Sep 2013 test		1.27E-05	-3.57E-05	-281%	
Arsenic	7440382	8.24E-06	8.24E-06	Aug/Sep 2013 test		1.00E-04	9.18E-05	92%	
Barium	7440393	0	2.01E-05	Jan 2013 HRA data		2.01E-05	2.01E-05	100%	
Beryllium	7440417	0	1.67E-05	2010 test reporting limit		0	0	--	
Cadmium	7440439	3.71E-05	3.71E-05	Aug/Sep 2013 test		9.59E-05	5.88E-05	61%	
Chromium	7440473	4.94E-06	4.94E-06	Aug/Sep 2013 test		0	-4.94E-06	--	
Cobalt	7440484	0	1.24E-05	Aug/Sep 2013 reporting limit		2.44E-05	2.44E-05	100%	
Copper	7440508	0	9.05E-06	Jan 2013 HRA data		7.25E-05	7.25E-05	100%	
Lead	7439921	5.40E-03	5.40E-03	Aug/Sep 2013 test		8.51E-04	-4.55E-03	-535%	
Manganese	7439965	1.14E-05	1.14E-05	Aug/Sep 2013 test		0	-1.14E-05	--	
Mercury	7439976	1.04E-04	1.04E-04	Aug/Sep 2013 test		3.14E-05	-7.26E-05	-231%	
Nickel	7440020	1.17E-05	1.17E-05	Aug/Sep 2013 test		0	-1.17E-05	--	
Phosphorus	7723140	4.12E-05	4.12E-05	Aug/Sep 2013 test		7.58E-04	7.17E-04	95%	
Selenium	7782492	0	9.08E-06	Jan 2013 HRA data		0	0	--	
Silver	7440224	7.62E-06	7.62E-06	Aug/Sep 2013 test		0	-7.62E-06	--	
Thallium	7440280	0	6.68E-06	2010 test reporting limit		0	0	--	
Vanadium	7440622	0	3.34E-05	2010 test reporting limit		0	0	--	
Zinc	7440666	3.19E-04	3.19E-04	Aug/Sep 2013 test		3.38E-04	1.90E-05	6%	
Formaldehyde	50000	5.89E-03	5.89E-03	Aug/Sep 2013 test		4.87E-03	-1.02E-03	-21%	
Acetaldehyde	75070	0	1.11E-03	Jan 2013 HRA data		3.70E-03	3.70E-03	100%	
Naphthalene	91203	1.15E-02	1.15E-02	Aug/Sep 2013 test		1.29E-02	1.40E-03	11%	
2-Methylnaphthalene	91576	7.63E-04	7.63E-04	Aug/Sep 2013 test		1.23E-03	4.67E-04	38%	
Acenaphthylene	208968	1.74E-03	1.74E-03	Aug/Sep 2013 test		1.14E-03	-6.00E-04	-53%	
Acenaphthene	83329	3.48E-05	3.48E-05	Aug/Sep 2013 test		3.88E-05	4.00E-06	10%	
Fluorene	86737	2.97E-04	2.97E-04	Aug/Sep 2013 test		3.85E-04	8.80E-05	23%	
Phenanthrene	85018	1.59E-03	1.59E-03	Aug/Sep 2013 test		3.24E-03	1.65E-03	51%	
Anthracene	120127	6.06E-05	6.06E-05	Aug/Sep 2013 test		1.90E-05	-4.16E-05	-219%	
Fluoranthene	206440	4.10E-04	4.10E-04	Aug/Sep 2013 test		3.03E-04	-1.07E-04	-35%	
Pyrene	129000	2.17E-04	2.17E-04	Aug/Sep 2013 test		6.23E-05	-1.55E-04	-248%	
Benz(a)anthracene	56553	2.34E-06	2.34E-06	Aug/Sep 2013 test		0	-2.34E-06	--	
Chrysene	218019	4.06E-05	4.06E-05	Aug/Sep 2013 test		8.10E-06	-3.25E-05	-401%	
Benzo(b)fluoranthene	205992	1.83E-06	1.83E-06	Aug/Sep 2013 test		0	-1.83E-06	--	
Benzo(k)fluoranthene	207089	3.08E-07	3.08E-07	Aug/Sep 2013 test		0	-3.08E-07	--	
Benzo(e)pyrene	192972	9.44E-07	9.44E-07	Aug/Sep 2013 test		0	-9.44E-07	--	
Benzo(a)pyrene	50328	0	9.65E-08	Jan 2013 HRA data		0	0	--	
Perylene	198550	0	0	Organic not detected in all tests		0	0	--	
Indeno(1,2,3-cd)pyrene	193395	0	0.00E+00	Organic not detected in all tests		0	0	--	
Dibenz(a,h)anthracene	53703	0	3.13E-07	Jan 2013 HRA data		0	0	--	
Benzo(ghi)perylene	191242	5.06E-07	5.06E-07	Aug/Sep 2013 test		0	-5.06E-07	--	
Chromium VI	18540299	1.25E-05	1.25E-05	Aug/Sep 2013 test		1.87E-06	-1.06E-05	-568%	
Benzene	71432	1.09E-02	1.09E-02	Aug/Sep 2013 test		6.19E-02	5.10E-02	82%	
Benzyl Chloride	100447	0	0	Organic not detected in all tests		0	0	--	
Bromodichloromethane	75274	0	0	Organic not detected in all tests		0	0	--	
Bromoform	75252	0	0	Organic not detected in all tests		0	0	--	
Bromomethane	74839	0	8.60E-05	Jan 2013 HRA data		0	0	--	
1,3-Butadiene	106990	1.16E-03	1.16E-03	Aug/Sep 2013 test		9.77E-02	9.65E-02	99%	
2-Butanone	78933	0	2.42E-04	Jan 2013 HRA data		0	0	--	
Carbon Disulfide	75150	0	0	Organic not detected in all tests		0	0	--	
Carbon Tetrachloride	56235	0	0	Organic not detected in all tests		0	0	--	
Chlorobenzene	108907	0	0	Organic not detected in all tests		0	0	--	
Chloroethane	75003	0	0	Organic not detected in all tests		0	0	--	
Chloroform	67663	0	0	Organic not detected in all tests		0	0	--	
Chloromethane	74873	3.05E-04	3.05E-04	Aug/Sep 2013 test		4.75E-04	1.70E-04	36%	
Dibromochloromethane	124481	0	0	Organic not detected in all tests		0	0	--	
1,1-Dichloroethane	75343	0	0	Organic not detected in all tests		0	0	--	
1,1-Dichloroethene	75354	0	0	Organic not detected in all tests		0	0	--	
1,2-Dibromoethane	106934	0	0	Organic not detected in all tests		0	0	--	
1,2-Dichlorobenzene	95501	0	0	Organic not detected in all tests		0	0	--	
1,2-Dichloroethane	107062	0	0	Organic not detected in all tests		0	0	--	
1,2-Dichloropropane	78875	0	0	Organic not detected in all tests		0	0	--	
1,3-Dichlorobenzene	541731	0	0	Organic not detected in all tests		0	0	--	
1,4-Dichlorobenzene	106467	0	0	Organic not detected in all tests		0	0	--	
1,4-Dioxane	123911	0	0	Organic not detected in all tests		0	0	--	
Ethylbenzene	100414	6.68E-04	6.68E-04	Aug/Sep 2013 test		1.72E-03	1.05E-03	61%	
Hexachloro-1,3-Butadiene	87683	0	0	Organic not detected in all tests		0	0	--	
MTBE	1634044	0	0	Organic not detected in all tests		0	0	--	
Methylene Chloride	75092	0	0	Organic not detected in all tests		0	0	--	
4-Methyl-2-Pentanone	108101	0	0	Organic not detected in all tests		0	0	--	
Styrene	100425	0	0	Organic not detected in all tests		3.24E-03	3.24E-03	100%	
Tetrachloroethene	127184	0	1.97E-03	Jan 2013 HRA data		0	0	--	

Table B-2 Summary of Soft Lead TAC Emissions

Exide Technologies
Vernon, California

Chemical	CAS	AB2588 Emission Rate - Aug/Sep2013 Tests ¹		Emission Rate Used for Health Metric Calculation ²	Emission Rate in Jan 2013 HRA	Reduction (Jan2013 – Aug/Sep2013)	Reduction Percentage (Reduction/Jan2013)
		lb/hr	lb/hr				
		lb/hr	lb/hr	Data Source ³	lb/hr	lb/hr	
Toluene	108883	1.11E-02	1.11E-02	Aug/Sep 2013 test	8.14E-03	-2.96E-03	-36%
Trichloroethene	79016	0	1.32E-04	Jan 2013 HRA data	0	0	--
Trichlorofluoromethane	75694	0	0	Organic not detected in all tests	0	0	--
1,1,2-Trichloro-1,2,2-Trifluoroethane	76131	0	0	Organic not detected in all tests	0	0	--
1,1,1-Trichloroethane	71556	0	0	Organic not detected in all tests	0	0	--
1,1,2-Trichloroethane	79005	0	0	Organic not detected in all tests	0	0	--
1,1,2,2-Tetrachloroethane	79345	0	0	Organic not detected in all tests	0	0	--
1,2,4-Trimethylbenzene	95636	0	0	Organic not detected in all tests	0	0	--
1,2,4-Trichlorobenzene	120821	0	0	Organic not detected in all tests	0	0	--
Vinyl Acetate	108054	0	4.85E-04	Jan 2013 HRA data	0	0	--
Vinyl Chloride	75014	0	0	Organic not detected in all tests	0	0	--

P:\E\Exide\HRA 2012 UPDATE\RRP_Revision_Nov2013\for HARP-Nov2013-RRP-current.xlsx\TB2_SL

Notes:

¹ The table lists the emission rates provided by Almega for the tests in August and September 2013. The values follow the CARB guidance for AB2588 emission inventory. Final laboratory reports have not been issued at the time of this report.

² ENVIRON followed the following hierarchy to select the values for the non-detect chemicals:

Metals: 1) used the value in Jan 2013 HRA, if the value in the Jan 2013 HRA is lower than the reporting limit in the Aug/Sep 2013 source tests; 2) otherwise, used the lowest laboratory reporting limit.

Organics: 1) used zero if the it was also below the reporting limits in the 2010 and 2012 source tests; 2) otherwise, use the lower value between the reporting limit of the August/September 2013 tests and the reported value in the Jan 2013 HRA

³ References:

Aug/Sept 2013 test - See note 1

2010 test - Almega. 2010. AB2588 Emissions Testing at the Exide Technologies, Vernon Facility, Hard Lead Refining System. Report #: 9015 – Soft Lead. May 16

Jan 2013 HRA - ENVIRON. 2013. Revised AB2588 Health Risk Assessment. January

Table B-3 Summary of Neptune TAC Emissions

Exide Technologies
Vernon, California

Chemical	CAS	Emission Rate Reported for Aug/Sep 2013 Tests ¹	Emission Rate Used for Health Metric Calculation ²		Emission Rate in Jan 2013 HRA	Reduction (Jan2013 – Aug/Sep2013)	Reduction Percentage (Reduction/Jan2013)
		lb/hr	lb/hr	Data Source ³	lb/hr	lb/hr	
Aluminum	7429905	4.06E-04	4.06E-04	Aug/Sep 2013 test	1.39E-03	9.79E-04	71%
Barium	7440393	5.91E-06	5.91E-06	Aug/Sep 2013 test	2.46E-05	1.86E-05	76%
Chromium	7440473	8.04E-06	8.04E-06	Aug/Sep 2013 test	5.67E-06	-2.38E-06	-42%
Cobalt	7440484	0	1.40E-06	Jan 2013 HRA data	1.40E-06	0	0%
Silver	7440224	0	1.18E-06	Jan 2013 HRA data	1.18E-06	0	0%
Thallium	7440280	0	1.49E-06	2010 test reporting limit	0	-1.49E-06	--
2-Methylnaphthalene	91576	2.52E-06	2.52E-06	Aug/Sep 2013 test	5.04E-06	2.52E-06	50%
Acenaphthylene	208968	1.50E-07	1.50E-07	Aug/Sep 2013 test	5.13E-07	3.63E-07	71%
Acenaphthene	83329	2.36E-07	2.36E-07	Aug/Sep 2013 test	5.95E-07	3.59E-07	60%
Fluorene	86737	3.63E-07	3.63E-07	Aug/Sep 2013 test	2.16E-06	1.80E-06	83%
Phenanthrene	85018	2.79E-06	2.79E-06	Aug/Sep 2013 test	2.15E-05	1.87E-05	87%
Anthracene	120127	0	6.19E-07	Jan 2013 HRA data	6.19E-07	0	0%
Fluoranthene	206440	3.33E-06	3.33E-06	Aug/Sep 2013 test	2.72E-05	2.38E-05	88%
Pyrene	129000	1.20E-06	1.20E-06	Aug/Sep 2013 test	1.65E-05	1.53E-05	93%
Benzo(e)pyrene	192972	9.62E-08	9.62E-08	Aug/Sep 2013 test	1.07E-06	9.69E-07	91%
Perylene	198550	0	0	Organic not detected in any tests	0	0	--
Benzo(ghi)perylene	191242	1.74E-07	1.74E-07	Aug/Sep 2013 test	0	-1.74E-07	--
Bromodichloromethane	75274	0	0	Organic not detected in any tests	0	0	--
Bromoform	75252	0	0	Organic not detected in any tests	0	0	--
Chloromethane	74873	0	8.67E-05	Aug/Sep 2013 test reporting limit	2.15E-04	1.28E-04	60%
Dibromochloromethane	124481	0	0	Organic not detected in any tests	0	0	--
1,2-Dichlorobenzene	95501	0	0	Organic not detected in any tests	0	0	--
1,3-Dichlorobenzene	541731	0	0	Organic not detected in any tests	0	0	--
Hexachloro-1,3-Butadiene	87683	0	0	Organic not detected in any tests	0	0	--
4-Methyl-2-Pentanone	108101	1.79E-03	1.79E-03	Aug/Sep 2013 test	0	-1.79E-03	--
1,2,4-Trimethylbenzene	95636	0	0	Organic not detected in any tests	0	0	--
1,2,4-Trichlorobenzene	120821	0	0	Organic not detected in any tests	0	0	--
Antimony	7440360	2.45E-05	2.45E-05	Aug/Sep 2013 test	5.14E-06	-1.94E-05	-377%
Arsenic	7440382	3.98E-06	3.98E-06	Aug/Sep 2013 test	3.39E-06	-5.90E-07	-17%
Beryllium	7440417	0	1.17E-06	AQMD April 2013 test	0	-1.17E-06	--
Cadmium	7440439	1.81E-05	1.81E-05	Aug/Sep 2013 test	6.69E-06	-1.14E-05	-171%
Copper	7440508	7.99E-05	7.99E-05	Aug/Sep 2013 test	9.05E-06	-7.09E-05	-783%
Lead	7439921	1.64E-03	1.64E-03	Aug/Sep 2013 test	4.97E-04	-1.14E-03	-230%
Manganese	7439965	1.62E-05	1.62E-05	Aug/Sep 2013 test	4.47E-06	-1.17E-05	-262%
Mercury	7439976	8.85E-04	8.85E-04	Aug/Sep 2013 test	6.96E-05	-8.15E-04	-1172%
Nickel	7440020	2.35E-05	2.35E-05	Aug/Sep 2013 test	2.90E-05	5.45E-06	19%
Phosphorus	7723140	3.62E-05	3.62E-05	Aug/Sep 2013 test	1.45E-04	1.08E-04	75%
Selenium	7782492	2.17E-05	2.17E-05	Aug/Sep 2013 test	9.08E-06	-1.26E-05	-139%
Vanadium	7440622	0	7.47E-06	2010 test reporting limit	0	-7.47E-06	--
Zinc	7440666	3.02E-04	3.02E-04	Aug/Sep 2013 test	1.00E-04	-2.02E-04	-202%
Formaldehyde	50000	2.30E-03	2.30E-03	Aug/Sep 2013 test	9.02E-04	-1.40E-03	-155%
Acetaldehyde	75070	2.08E-03	2.08E-03	Aug/Sep 2013 test	1.11E-03	-9.73E-04	-88%
Naphthalene	91203	1.18E-05	1.18E-05	Aug/Sep 2013 test	1.89E-05	7.05E-06	37%
Benz(a)anthracene	56553	0	1.09E-07	Aug/Sep 2013 test reporting limit	1.41E-06	1.31E-06	92%
Chrysene	218019	1.96E-06	1.96E-06	Aug/Sep 2013 test	1.33E-05	1.13E-05	85%
Benzo(b)fluoranthene	205992	1.11E-07	1.11E-07	Aug/Sep 2013 test	1.51E-06	1.39E-06	93%
Benzo(k)fluoranthene	207089	0	1.09E-07	Aug/Sep 2013 test reporting limit	4.18E-07	3.09E-07	74%
Benzo(a)pyrene	50328	0	9.65E-08	Jan 2013 HRA data	9.65E-08	0	0%
Indeno(1,2,3-cd)pyrene	193395	0	0	Organic not detected in any tests	0	0	--
Dibenz(a,h)anthracene	53703	0	1.09E-07	Aug/Sep 2013 test reporting limit	3.13E-07	2.04E-07	65%
TEQ (Min) as 2,3,7,8-TCDD	1086	5.41E-10	5.41E-10	Aug/Sep 2013 test	3.17E-09	2.63E-09	83%
Total PCBs	1336363	1.17E-06	1.17E-06	Aug/Sep 2013 test	3.95E-06	2.78E-06	70%
Chromium VI	18540299	4.96E-06	4.96E-06	Aug/Sep 2013 test	2.90E-05	2.40E-05	83%
Benzene	71432	2.11E-04	2.11E-04	Aug/Sep 2013 test	7.15E-05	-1.40E-04	-195%
Benzyl Chloride	100447	0	0	Organic not detected in any tests	0	0	--
Bromomethane	74839	0	8.60E-05	Jan 2013 HRA data	8.60E-05	0	0%
1,3-Butadiene	106990	0	1.93E-04	2012 test reporting limit	7.05E-03	6.86E-03	97%
2-Butanone	78933	7.97E-03	7.97E-03	Aug/Sep 2013 test	2.42E-04	-7.73E-03	-3193%
Carbon Disulfide	75150	0	0	Organic not detected in any tests	0	0	--
Carbon Tetrachloride	56235	0	0	Organic not detected in any tests	0	0	--

Table B-3 Summary of Neptune TAC Emissions

Exide Technologies
Vernon, California

Chemical	CAS	Emission Rate Reported for Aug/Sep 2013 Tests ¹	Emission Rate Used for Health Metric Calculation ²		Emission Rate in Jan 2013 HRA	Reduction (Jan2013 – Aug/Sep2013)	Reduction Percentage (Reduction/Jan2013)
		lb/hr	lb/hr	Data Source ³	lb/hr	lb/hr	
Chlorobenzene	108907	0	0	Organic not detected in any tests	0	0	--
Chloroethane	75003	0	0	Organic not detected in any tests	0	0	--
Chloroform	67663	0	0	Organic not detected in any tests	0	0	--
1,1-Dichloroethane	75343	0	0	Organic not detected in any tests	0	0	--
1,1-Dichloroethene	75354	0	0	Organic not detected in any tests	0	0	--
1,2-Dibromoethane	106934	0	0	Organic not detected in any tests	0	0	--
1,2-Dichloroethane	107062	0	0	Organic not detected in any tests	0	0	--
1,2-Dichloropropane	78875	0	0	Organic not detected in any tests	0	0	--
1,4-Dichlorobenzene	106467	0	0	Organic not detected in any tests	0	0	--
1,4-Dioxane	123911	0	0	Organic not detected in any tests	0	0	--
Ethylbenzene	100414	3.18E-04	3.18E-04	Aug/Sep 2013 test	0	-3.18E-04	--
MTBE	1634044	0	0	Organic not detected in any tests	0	0	--
Methylene Chloride	75092	0	0	Organic not detected in any tests	0	0	--
Styrene	100425	0	0	Organic not detected in any tests	0	0	--
Tetrachloroethene	127184	5.72E-04	5.72E-04	Aug/Sep 2013 test	1.97E-03	1.40E-03	71%
Toluene	108883	2.91E-04	2.91E-04	Aug/Sep 2013 test	5.84E-04	2.93E-04	50%
Trichloroethene	79016	0	1.32E-04	Jan 2013 HRA data	1.32E-04	0	0%
Trichlorofluoromethane	75694	0	0	Organic not detected in any tests	0	0	--
1,1,2-Trichloro-1,2,2-Trifluoroethane	76131	0	0	Organic not detected in any tests	0	0	--
1,1,1-Trichloroethane	71556	0	0	Organic not detected in any tests	0	0	--
1,1,2-Trichloroethane	79005	0	0	Organic not detected in any tests	0	0	--
1,1,2,2-Tetrachloroethane	79345	0	0	Organic not detected in any tests	0	0	--
Vinyl Acetate	108054	1.70E-01	1.70E-01	Aug/Sep 2013 test	4.85E-04	-1.70E-01	-34952%
Vinyl Chloride	75014	0	0	Organic not detected in any tests	0	0	--

P:\E\Exide\HRA 2012 UPDATE\RRP_Revision_Nov2013\for HARP-Nov2013-RRP-current.xlsx\TB3_Neptune

Notes:

¹ The table lists the emission rates provided by Almega for the tests in August and September 2013. The values follow the CARB guidance for AB2588 emission inventory. Final laboratory reports have not been issued at the time of this report.

² ENVIRON followed the following hierarchy to select the values for the non-detect chemicals:

Metals: 1) used the value in Jan 2013 HRA, if the value in the Jan 2013 HRA is lower than the reporting limit in the Aug/Sep 2013 source tests; 2) otherwise, used the lowest laboratory reporting limit. Exception: beryllium was found to have a lower reporting limit in the AQMD May test.

Organics: 1) used zero if it was also below the reporting limits in the 2010 and 2012 source tests; 2) otherwise, use the lower value between the reporting limit of the August/September 2013 tests and the reported value in the Jan 2013 HRA

³ References:

Aug/Sept 2013 test - See note 1

2010 test - Almega. 2010. AB2588 Emissions Testing at the Exide Technologies, Vernon Facility, Hard Lead Refining System. Report #: 9015 – Neptune. May 4

2012 test - Almega. 2010. AB2588 Emissions Testing at the Exide Technologies, Vernon Facility, Hard Lead Refining System. Report #: 9256 – Neptune. August 8.

AQMD April test - AQMD. 2013. Source Tests Report 13-305 Conducted at Exide Technologies: Multiple Metal Emissions from the Neptune/venturi Exhaust Stack. May 17

Jan 2013 HRA - ENVIRON. 2013. Revised AB2588 Health Risk Assessment. January

Table B-4 Summary of South and North Torits TAC Emissions

Exide Technologies
 Vernon, California

Chemical	CAS	September 2013 Test Result ¹	Value Used for Health Risk Calculation ²		Emission Rate in Jan 2013 HRA	Reduction (Jan2013 – Sep2013)	Reduction Percentage (Reduction/Jan2013)
		lb/hr	lb/hr	Data Source ³	lb/hr	lb/hr	
South Torit							
Aluminum	7429905	8.54E-04	8.54E-04	Sep 2013 test	3.15E-03	2.30E-03	73%
Antimony	7440360	<0.000132	1.32E-04	Sep 2013 test reporting limit	3.36E-04	2.04E-04	61%
Arsenic	7440382	<0.000123	4.83E-05	Jan 2013 HRA	4.83E-05	0.00E+00	0%
Barium	7440393	3.35E-05	3.35E-05	Sep 2013 test	5.48E-05	2.13E-05	39%
Beryllium	7440417	<0.000308	2.22E-05	2010 test reporting limit	0	-2.22E-05	--
Cadmium	7440439	2.73E-05	2.73E-05	Sep 2013 test	2.19E-05	-5.40E-06	-25%
Chromium	7440473	7.05E-05	7.05E-05	Sep 2013 test	0	-7.05E-05	--
Cobalt	7440484	<0.0000352	8.88E-06	2010 test reporting limit	0	-8.88E-06	--
Copper	7440508	7.75E-04	7.75E-04	Sep 2013 test	6.07E-05	-7.14E-04	-1177%
Lead	7439921	3.82E-03	3.82E-03	Sep 2013 test	3.60E-03	-2.20E-04	-6%
Manganese	7439965	3.17E-05	3.17E-05	Sep 2013 test	1.92E-05	-1.25E-05	-65%
Nickel	7440020	3.99E-04	3.99E-04	Sep 2013 test	5.92E-06	-3.93E-04	-6640%
Phosphorus	7723140	<0.000881	8.81E-04	Sep 2013 test reporting limit	0	-8.81E-04	--
Selenium	7782492	<0.000123	1.78E-05	2010 test reporting limit	0	-1.78E-05	--
Silver	7440224	4.05E-05	4.05E-05	Sep 2013 test	0	-4.05E-05	--
Thallium	7440280	<0.0000352	8.88E-06	2010 test reporting limit	0	-8.88E-06	--
Vanadium	7440622	<0.000176	4.44E-05	2010 test reporting limit	--	--	--
Zinc	7440666	7.40E-04	7.40E-04	Sep 2013 test	1.81E-04	-5.59E-04	-309%
Iron	7439896	2.99E-03	2.99E-03	Sep 2013 test	--	--	--
Acetone	67641	2.42E-02	2.42E-02	Sep 2013 test	--	--	--
Benzene	71432	5.35E-03	5.35E-03	Sep 2013 test	--	--	--
Chloromethane	74873	3.04E-04	3.04E-04	Sep 2013 test	--	--	--
Toluene	108883	9.39E-03	9.39E-03	Sep 2013 test	--	--	--
North Torit							
Aluminum	7429905	9.72E-04	9.72E-04	Sep 2013 test	3.18E-03	2.21E-03	69%
Antimony	7440360	<0.000133	1.81E-05	Jan 2013 HRA	1.81E-05	0	0%
Arsenic	7440382	<0.000124	1.24E-04	Sep 2013 test reporting limit	8.69E-04	7.45E-04	86%
Barium	7440393	8.75E-05	8.75E-05	Sep 2013 test	1.11E-05	-7.64E-05	-688%
Beryllium	7440417	<0.000309	1.85E-05	2010 test reporting limit	0	-1.85E-05	--
Cadmium	7440439	<0.000106	4.36E-05	Jan 2013 HRA	4.36E-05	0	0%
Chromium	7440473	2.92E-05	2.92E-05	Sep 2013 test	0	-2.92E-05	--
Cobalt	7440484	<0.0000353	5.05E-06	2010 test report	5.05E-06	0	0%
Copper	7440508	4.33E-04	4.33E-04	Sep 2013 test	0	-4.33E-04	--
Lead	7439921	2.50E-03	2.50E-03	Sep 2013 test	1.41E-03	-1.09E-03	-77%
Manganese	7439965	2.03E-04	2.03E-04	Sep 2013 test	2.25E-04	2.20E-05	10%
Nickel	7440020	3.53E-05	3.53E-05	Sep 2013 test	5.17E-05	1.64E-05	32%
Phosphorus	7723140	<0.000884	8.84E-04	Sep 2013 test reporting limit	0	-8.84E-04	--
Selenium	7782492	<0.000124	7.39E-06	2010 test reporting limit	0	-7.39E-06	--
Silver	7440224	<0.0000353	9.97E-06	2010 test report	9.97E-06	0	0%
Thallium	7440280	<0.0000353	7.39E-06	2010 test reporting limit	0	-7.39E-06	--
Vanadium	7440622	<0.000177	3.69E-05	2010 test reporting limit	--	--	--
Zinc	7440666	4.33E-04	4.33E-04	Sep 2013 test	2.56E-04	-1.77E-04	-69%
Iron	7439896	1.86E-03	1.86E-03	Sep 2013 test	--	--	--
Acetone	67641	3.20E-02	3.20E-02	Sep 2013 test	--	--	--
Benzene	71432	9.38E-03	9.38E-03	Sep 2013 test	--	--	--
Chloromethane	74873	4.39E-04	4.39E-04	Sep 2013 test	--	--	--
Toluene	108883	1.59E-02	1.59E-02	Sep 2013 test	--	--	--
Trichloroethene	79016	7.33E-04	7.33E-04	Sep 2013 test	--	--	--

P:\Exide\HRA 2012 UPDATE\RRP_Revision_Nov2013\for HARP-Nov2013-RRP-current.xlsx\TB4_Torits

Notes:

¹ Almega. 2013. Emissions Testing at the Exide Technologies, Vernon Facility, North Torit and South Torit Baghouses (Source Test Report for AQMD). October 21.

² ENVIRON followed the following hierarchy to select the values for the non-detect chemicals:

Metals: 1) used the value in Jan 2013 HRA, if the value in the Jan 2013 HRA is lower than the reporting limit in the Sep 2013 source tests; 2) otherwise, used the lowest laboratory reporting limit.

Organics: only listed the detected compounds. Organics were not tested previously and therefore not reported in the Jan 2013 HRA.

³ References:

Sept 2013 test - See note 1

2010 test (a) - Almega. 2010. AB2588 Emissions Testing at the Exide Technologies, Vernon Facility, Hard Lead Refining System. Report #: 9015 – South Torits. May 16

2011 test (b) - Almega. 2010. AB2588 Emissions Testing at the Exide Technologies, Vernon Facility, Hard Lead Refining System. Report #: 9015 – North Torits. May 12

Jan 2013 HRA - ENVIRON. 2013. Revised AB2588 Health Risk Assessment. January

Table B-5 Summary of Facility-Wide Emissions of TACs

Exide Technologies
 Vernon, California

Chemical Name	CAS #	Max Hourly Emission Rate	Max Hourly Emission Rate	Annual Emission Rate	Annual Emission Rate
		(lb/hr)	(g/s)	(lb/yr)	(g/s)
1,1,1 -Trichloroethane	71556	0	0	0	0
1,1,2,2-Tetrachloroethane	79345	0	0	0	0
1,1,2-Trichloro-1,2,2-Trifluoroethane	76131	0	0	0	0
1,1,2-Trichloroethane	79005	0	0	0	0
1,1-Dichloroethane	75343	0	0	0	0
1,1-Dichloroethene	75354	2.85E-04	3.59E-05	2.50E+00	3.59E-05
1,2,4-Trichlorobenzene	120821	0	0	0	0
1,2,4-Trimethylbenzene	95636	3.30E-03	4.16E-04	2.89E+01	4.16E-04
1,2-Dibromoethane	106934	0	0	0	0
1,2-Dichlorobenzene	95501	0	0	0	0
1,2-Dichloroethane	107062	0	0	0	0
1,2-Dichloropropane	78875	0	0	0	0
1,3-Butadiene	106990	2.68E-02	3.38E-03	2.35E+02	3.38E-03
1,3-Dichlorobenzene	541731	0	0	0	0
1,4-Dichlorobenzene	106467	0	0	0	0
1,4-Dioxane	123911	0	0	0	0
2-Butanone	78933	1.63E-02	2.06E-03	1.43E+02	2.06E-03
2-Methylnaphthalene	91576	2.41E-03	3.03E-04	2.11E+01	3.03E-04
4-Methyl-2-Pentanone	108101	2.93E-03	3.69E-04	2.57E+01	3.69E-04
Acenaphthene	83329	1.02E-04	1.29E-05	8.97E-01	1.29E-05
Acenaphthylene	208968	2.16E-03	2.72E-04	1.89E+01	2.72E-04
Acetaldehyde	75070	2.02E-02	2.54E-03	1.77E+02	2.54E-03
Acrolein	107028	3.37E-07	4.25E-08	2.96E-03	4.25E-08
Aluminum	7429905	1.66E-01	2.09E-02	1.45E+03	2.09E-02
Ammonia	7664417	2.25E-03	2.83E-04	1.97E+01	2.83E-04
Anthracene	120127	1.83E-04	2.30E-05	1.60E+00	2.30E-05
Antimony	7440360	5.67E-04	7.14E-05	4.80E+00	6.91E-05
Arsenic	7440382	4.52E-04	5.70E-05	3.94E+00	5.66E-05
Barium	7440393	1.20E-03	1.51E-04	1.05E+01	1.51E-04
Benz(a)anthracene	56553	1.80E-05	2.27E-06	1.58E-01	2.27E-06
Benzene	71432	2.64E-01	3.32E-02	2.31E+03	3.32E-02
Benzo(a)pyrene	50328	3.55E-07	4.47E-08	3.11E-03	4.47E-08
Benzo(b)fluoranthene	205992	4.79E-06	6.04E-07	4.20E-02	6.04E-07
Benzo(e)pyrene	192972	2.24E-06	2.82E-07	1.96E-02	2.82E-07
Benzo(ghi)perylene	191242	9.74E-07	1.23E-07	8.53E-03	1.23E-07
Benzo(k)fluoranthene	207089	1.01E-06	1.27E-07	8.84E-03	1.27E-07
Benzyl Chloride	100447	0	0	0	0
Beryllium	7440417	7.70E-05	9.70E-06	6.74E-01	9.70E-06
Bromodichloromethane	75274	0	0	0	0
Bromoform	75252	0	0	0	0
Bromomethane	74839	1.69E-03	2.13E-04	1.48E+01	2.13E-04
Cadmium	7440439	2.61E-04	3.29E-05	2.28E+00	3.28E-05
Carbon Disulfide	75150	1.65E-02	2.08E-03	1.45E+02	2.08E-03
Carbon Tetrachloride	56235	0	0	0	0
Chlorobenzene	108907	5.55E-04	6.99E-05	4.86E+00	6.99E-05
Chlorodibromomethane	124481	0	0	0	0
Chloro methane	74873	3.46E-03	4.36E-04	3.03E+01	4.36E-04
Chloroethane	75003	4.84E-04	6.10E-05	4.24E+00	6.10E-05
Chloroform	67663	4.10E-04	5.17E-05	3.59E+00	5.17E-05
Chromium	7440473	7.71E-04	9.71E-05	6.73E+00	9.68E-05
Chromium VI	18540299	1.12E-04	1.42E-05	9.85E-01	1.42E-05
Chrysene	218019	1.09E-04	1.38E-05	9.59E-01	1.38E-05
Cobalt	7440484	1.36E-04	1.72E-05	1.19E+00	1.72E-05
Copper	7440508	1.75E-03	2.21E-04	1.52E+01	2.19E-04
Dibenz(a,h)anthracene	53703	4.22E-07	5.32E-08	3.70E-03	5.32E-08
Ethylbenzene	100414	7.43E-03	9.36E-04	6.51E+01	9.36E-04
Fluoranthene	206440	6.85E-04	8.63E-05	6.00E+00	8.63E-05
Fluorene	86737	5.40E-04	6.81E-05	4.73E+00	6.81E-05

Table B-5 Summary of Facility-Wide Emissions of TACs

Exide Technologies
 Vernon, California

Chemical Name	CAS #	Max Hourly Emission Rate	Max Hourly Emission Rate	Annual Emission Rate	Annual Emission Rate
		(lb/hr)	(g/s)	(lb/yr)	(g/s)
Formaldehyde	50000	3.44E-02	4.34E-03	3.02E+02	4.34E-03
Hexachloro-1,3-Butadiene	87683	0	0	0	0
Hexane	110543	7.88E-07	9.93E-08	6.90E-03	9.92E-08
Indeno(1,2,3-cd)pyrene	193395	1.69E-07	2.13E-08	1.48E-03	2.13E-08
Lead	7439921	3.05E-02	3.84E-03	2.61E+02	3.75E-03
Manganese	7439965	4.08E-04	5.14E-05	3.53E+00	5.07E-05
Mercury	7439976	1.09E-03	1.37E-04	9.54E+00	1.37E-04
Methylene Chloride	75092	0	0	0	0
Methyl-t-Butyl Ether (MTBE)	1634044	0	0	0	0
Naphthalene	91203	3.02E-02	3.80E-03	2.64E+02	3.80E-03
Nickel	7440020	6.82E-04	8.59E-05	5.93E+00	8.52E-05
Perylene	198550	0	0	0	0
Phenanthrene	85018	3.45E-03	4.34E-04	3.02E+01	4.34E-04
Phosphorus	7723140	2.79E-03	3.51E-04	2.43E+01	3.50E-04
Pyrene	129000	3.74E-04	4.72E-05	3.28E+00	4.72E-05
Selenium	7782492	9.57E-05	1.21E-05	8.27E-01	1.19E-05
Silver	7440224	8.60E-05	1.08E-05	7.53E-01	1.08E-05
Styrene	100425	2.45E-02	3.09E-03	2.15E+02	3.09E-03
TEQ (Min) as 2,3,7,8-TCDD	1086	8.49E-10	1.07E-10	7.44E-06	1.07E-10
Tetrachloroethene	127184	2.54E-03	3.20E-04	2.23E+01	3.20E-04
Thallium	7440280	3.12E-05	3.93E-06	2.73E-01	3.93E-06
Toluene	108883	7.22E-02	9.10E-03	6.32E+02	9.10E-03
Total PAHs (excl.Naphthalene)	1151	1.25E-08	1.58E-09	1.09E-04	1.57E-09
Total PCBs, as MonoCB	1336363	8.56E-04	1.08E-04	7.50E+00	1.08E-04
Trichloroethene	79016	2.28E-03	2.87E-04	2.00E+01	2.87E-04
Trichlorofluoro methane	75694	0	0	0	0
Vanadium	7440622	1.29E-04	1.62E-05	1.13E+00	1.62E-05
Vinyl Acetate	108054	1.77E-01	2.23E-02	1.55E+03	2.23E-02
Vinyl Chloride	75014	2.80E-04	3.53E-05	2.45E+00	3.53E-05
Xylenes	1330207	1.96E-02	2.47E-03	1.72E+02	2.47E-03
Zinc	7440666	3.36E-03	4.23E-04	2.91E+01	4.19E-04

P:\E\Exide\Risk Reduction Plan 2013\App B\Table B-5 ES.xlsx\table 5

Note:

lb/hr = pounds per hour; lb/yr = pounds per year; g/s = grams per second

Figures

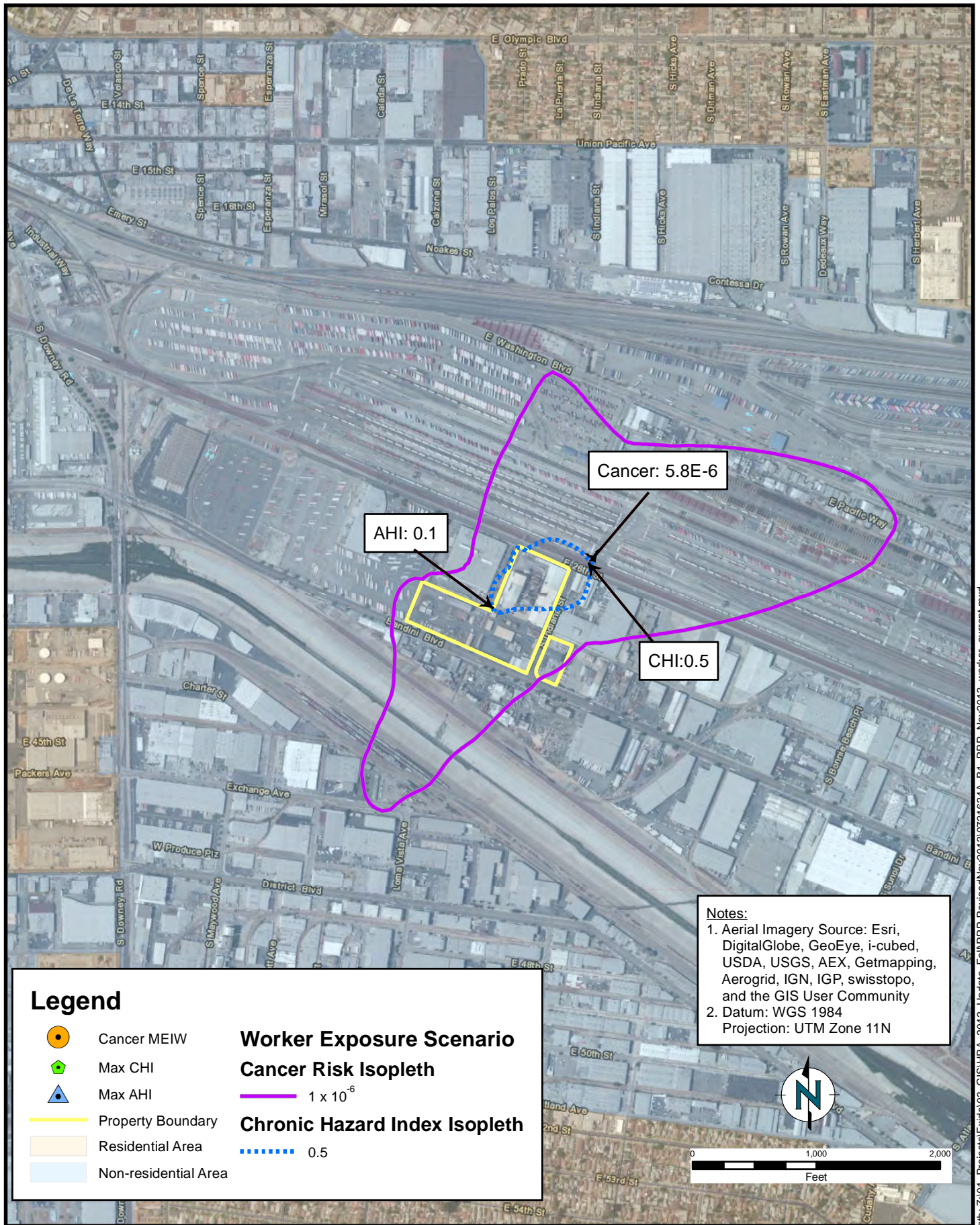

Path: Z:\01_Projects\Exide\03_GIS\HRA_2012_Update_Fall\RRP-Updated\Nov2013\0721624A_B1_RRP_Nov2013_worker_current.mxd

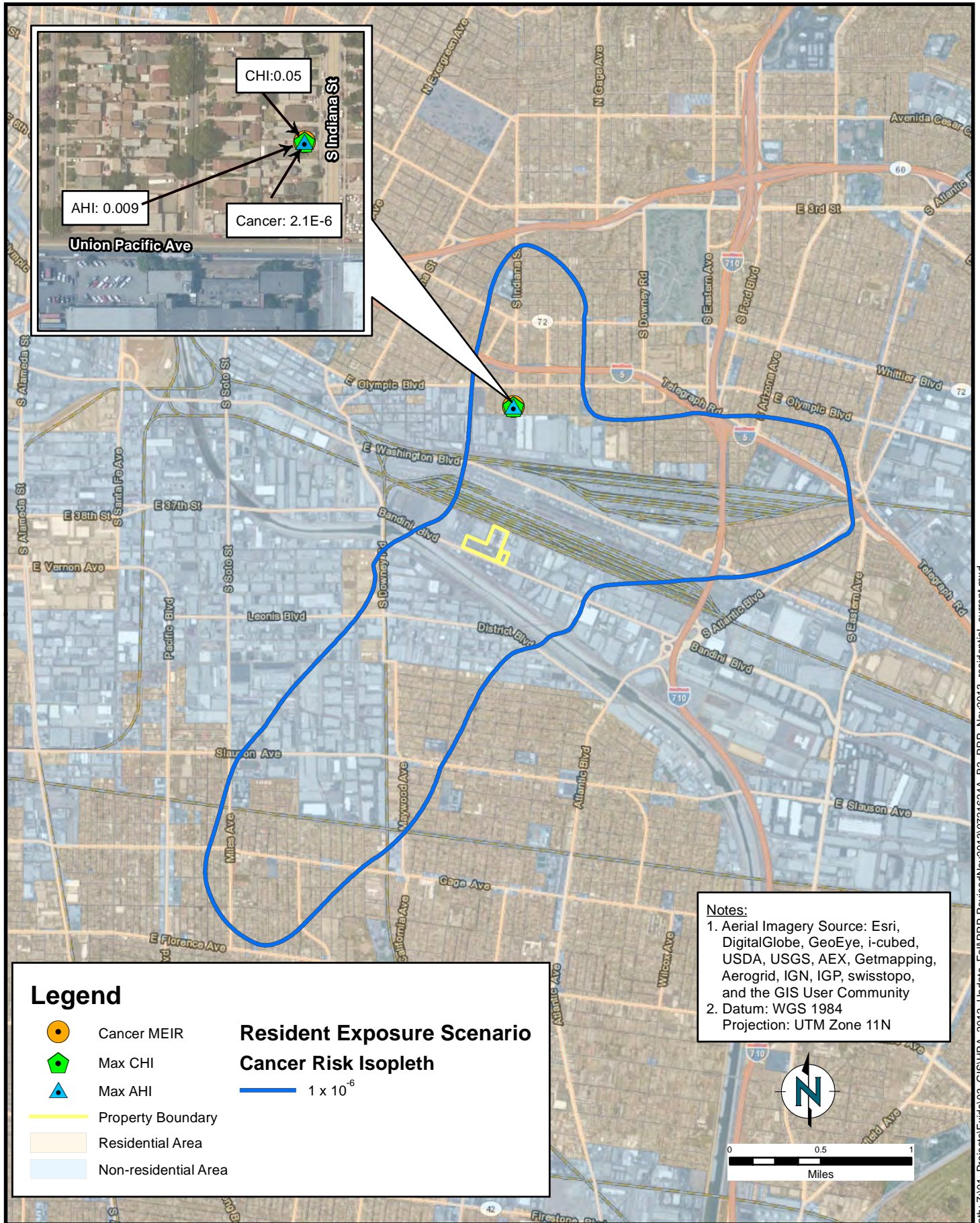

Path: Z:\01_Projects\Exide\03_GIS\HRA_2012_Update_Fall\RRP-Revised\Nov2013\0721624A_B2_RRP_Nov2013_residential_current.mxd

Appendix B.d

Updated Emissions Inventory and Health Risk Assessment – AQMD Test Data

Appendix B.d Updated Health Risk Assessment Using AQMD Results

On August 8 and 23, and September 20, 2013, AQMD conducted source tests for the stacks of the Hard Lead Ventilation System (Hard Lead) and Soft Lead Ventilation System (Soft Lead). ENVIRON estimated the health metrics after substituting the emission data presented in Appendix B with the AQMD source test results. The AQMD data are summarized in Tables B.d-1 and B.d-2. All other air toxic emissions are the same as those in Appendix B. The facility wide emission rates used in this analysis are summarized in Table B.d-3. The modeling and risk assessment methods are as described in Appendix B.

Using the results of the AQMD tests for Hard Lead and Soft Lead stacks, the cancer risk at the Maximally Exposed Individual Worker (MEIW) is estimated to be 9.8 in a million or $9.8E-6$. The MEIW is at Receptor 1005 (389900, 3763600) and is located in the railyard north of the facility (see Figure B.d-1). The cancer risk at the Maximally Exposed Individual Resident (MEIR) is estimated to be 2.7 in a million or $2.7E-6$. The MEIR is at Receptor 1016 (389900, 3764700) and is located in the residential area north of the facility (see Figure B.d-2). Both maximum cancer risks are below the AQMD Rule 1402 Action Risk Level of 25 in a million and public notification threshold of 10 in a million.

The cancer burden is estimated to be 0.2, which is below the AQMD Rule 1402 Action Risk Level of 0.5.

The maximum Chronic Hazard Index (CHI) for the worker scenario is estimated to be 1.9 (below the AQMD Rule 1402 Action Risk Level of 3.0) and is at the same location as the MEIW (see Figure B.d-1). The maximum CHI for the residential scenario is estimated to be 0.1 (below the AQMD Rule 1402 Action Risk Level of 3.0 and public notification threshold of 1.0) and is at the same location as the MEIR (see Figure B.d-2).

The maximum Acute Hazard Index (AHI) [i.e. Point of Maximum Impact (PMI)] at the MEIW is estimated to be 0.2. It is at Receptor 73 (389710, 3763600) and is located on the western fence line near the 26th street entrance (see Figure B.d-1). The maximum AHI for the residential scenario is estimated to be 0.009. It is at the same location as the MEIR (see Figure B.d-2). Both AHIs are below the AQMD Rule 1402 Action Risk Level of 3.0 and public notification threshold of 1.0.

Tables

Table B.d-1 Summary of Source Test Results for Hard Lead - AQMD Test Data

Exide Technologies

Vernon, California

Chemical	CAS	AQMD Aug-Sep 2013 Test Averages ¹ (lb/hr)
Lead	7439921	1.64E-02
Arsenic	7440382	1.12E-03
Cadmium	7440439	1.36E-04
Manganese	7439965	1.71E-04
Nickel	7440020	1.67E-04
Chromium	7440473	1.01E-04
Antimony	7440360	8.15E-05
Selenium	7782492	7.40E-05
Barium	7440393	4.04E-04
Zinc	7440666	3.31E-03
Tin	7440315	3.12E-02
Titanium	7440326	1.96E-04
Copper	7440508	8.33E-04
Cobalt	7440484	1.13E-05
Iron	7439896	4.96E-03
1,3-Butadiene	106990	2.43E-02
Benzene	71432	1.19E-01
Acrolein	107028	2.08E-03
Methylene chloride	75092	5.89E-04
MEK	78933	1.73E-03
Chloroform	67663	5.33E-04
Toluene	108883	3.03E-02
Ethylbenzene	100414	6.51E-03
Styrene	100425	1.11E-01
n-Hexane	110543	3.88E-03
Propylene	115071	1.02E-01
Tetrachloroethylene	127184	8.64E-05
Carbon Tetrachloride	56235	8.01E-05
Xylenes	1330207	1.42E-02

P:\E\Exide\HRA 2012 UPDATE\RRP_Revision_Nov2013\for HARP-Nov2013-RRP-current upper district.xlsx\TBd1_HL

Note:

¹ AQMD. 2013. Source Tests Report 13-307 and 13-308 Conducted at Exide Technologies: Multiple Metal and Toxic Organic Emissions from the Hard and Soft Lead Baghouse Exhaust Stacks. October 7, 2013.

Table B.d-2 Summary of Source Test Results for Soft Lead - AQMD Test Data

Exide Technologies

Vernon, California

Chemical	CAS	AQMD Aug-Sep 2013 Test Averages (lb/hr)
Lead	7439921	1.02E-02
Arsenic	7440382	4.83E-05
Cadmium	7440439	9.20E-05
Manganese	7439965	1.21E-04
Nickel	7440020	6.66E-05
Chromium	7440473	8.76E-05
Antimony	7440360	6.90E-05
Selenium	7782492	1.29E-05
Barium	7440393	1.82E-04
Zinc	7440666	1.73E-03
Tin	7440315	4.35E-02
Titanium	7440326	2.45E-04
Copper	7440508	2.59E-04
Cobalt	7440484	3.68E-06
Iron	7439896	1.73E-02
Beryllium	7440417	1.47E-07
1,3-Butadiene	106990	5.23E-03
Benzene	71432	7.81E-02
Acrolein	107028	1.47E-03
Methylene chloride	75092	3.16E-04
MEK	78933	1.06E-03
Chloroform	67663	3.49E-04
Toluene	108883	1.53E-02
Ethylbenzene	100414	3.04E-03
Styrene	100425	1.08E-02
n-Hexane	110543	6.24E-04
Propylene	115071	4.10E-02
Carbon Tetrachloride	56235	6.77E-05
Xylenes	1330207	1.66E-02

P:\E\Exide\HRA 2012 UPDATE\RRP_Revision_Nov2013\for HARP-Nov2013-RRP-current upper district.xlsx]TBd2_SL

Note:

¹ AQMD. 2013. Source Tests Report 13-307 and 13-308 Conducted at Exide Technologies: Multiple Metal and Toxic Organic Emissions from the Hard and Soft Lead Baghouse Exhaust Stacks. October 2013.

Table B.d-3 Summary of Facility-Wide Emissions of TACs - AQMD Test Data
Exide Technologies
Vernon, CA

Chemical Name	CAS #	Max Hourly Emission Rate	Max Hourly Emission Rate	Annual Emission Rate	Annual Emission Rate
		lb/hr	g/s	lb/yr	g/s
1,1,1 -Trichloroethane	71556	0	0	0	0
1,1,2,2-Tetrachloroethane	79345	0	0	0	0
1,1,2-Trichloro-1,2,2-Trifluoroethane	76131	0	0	0	0
1,1,2-Trichloroethane	79005	0	0	0	0
1,1-Dichloroethane	75343	0	0	0	0
1,1-Dichloroethene	75354	2.85E-04	3.59E-05	2.50E+00	3.59E-05
1,2,4-Trichlorobenzene	120821	0	0	0	0
1,2,4-Trimethylbenzene	95636	3.30E-03	4.16E-04	2.89E+01	4.16E-04
1,2-Dibromoethane	106934	0	0	0	0
1,2-Dichlorobenzene	95501	0	0	0	0
1,2-Dichloroethane	107062	0	0	0	0
1,2-Dichloropropane	78875	0	0	0	0
1,3-Butadiene	106990	4.64E-02	5.85E-03	4.07E+02	5.85E-03
1,3-Dichlorobenzene	541731	0	0	0	0
1,4-Dichlorobenzene	106467	0	0	0	0
1,4-Dioxane	123911	0	0	0	0
2-Butanone	78933	1.57E-02	1.98E-03	1.38E+02	1.98E-03
2-Methylnaphthalene	91576	2.41E-03	3.03E-04	2.11E+01	3.03E-04
4-Methyl-2-Pentanone	108101	2.93E-03	3.69E-04	2.57E+01	3.69E-04
Acenaphthene	83329	1.02E-04	1.29E-05	8.97E-01	1.29E-05
Acenaphthylene	208968	2.16E-03	2.72E-04	1.89E+01	2.72E-04
Acetaldehyde	75070	2.02E-02	2.54E-03	1.77E+02	2.54E-03
Acrolein	107028	3.37E-07	4.25E-08	2.96E-03	4.25E-08
Aluminum	7429905	1.66E-01	2.09E-02	1.45E+03	2.09E-02
Ammonia	7664417	2.25E-03	2.83E-04	1.97E+01	2.83E-04
Anthracene	120127	1.83E-04	2.30E-05	1.60E+00	2.30E-05
Antimony	7440360	6.50E-04	8.19E-05	5.53E+00	7.96E-05
Arsenic	7440382	1.51E-03	1.91E-04	1.32E+01	1.90E-04
Barium	7440393	1.75E-03	2.21E-04	1.53E+01	2.20E-04
Benz(a)anthracene	56553	1.80E-05	2.27E-06	1.58E-01	2.27E-06
Benzene	71432	4.00E-01	5.04E-02	3.50E+03	5.04E-02
Benzo(a)pyrene	50328	3.55E-07	4.47E-08	3.11E-03	4.47E-08
Benzo(b)fluoranthene	205992	4.79E-06	6.04E-07	4.20E-02	6.04E-07
Benzo(e)pyrene	192972	2.24E-06	2.82E-07	1.96E-02	2.82E-07
Benzo(ghi)perylene	191242	9.74E-07	1.23E-07	8.53E-03	1.23E-07
Benzo(k)fluoranthene	207089	1.01E-06	1.27E-07	8.84E-03	1.27E-07
Benzyl Chloride	100447	0	0	0	0
Beryllium	7440417	6.04E-05	7.61E-06	5.29E-01	7.61E-06
Bromodichloromethane	75274	0	0	0	0
Bromoform	75252	0	0	0	0
Bromomethane	74839	1.69E-03	2.13E-04	1.48E+01	2.13E-04
Cadmium	7440439	3.93E-04	4.95E-05	3.43E+00	4.93E-05
Carbon Disulfide	75150	1.65E-02	2.08E-03	1.45E+02	2.08E-03
Carbon Tetrachloride	56235	1.48E-04	0	1.29E+00	0
Chlorobenzene	108907	5.55E-04	6.99E-05	4.86E+00	6.99E-05
Chlorodibromomethane	124481	0	0	0	0
Chloro methane	74873	3.46E-03	4.36E-04	3.03E+01	4.36E-04
Chloroethane	75003	4.84E-04	6.10E-05	4.24E+00	6.10E-05
Chloroform	67663	1.29E-03	1.63E-04	1.13E+01	1.63E-04
Chromium	7440473	9.48E-04	1.19E-04	8.28E+00	1.19E-04

Table B.d-3 Summary of Facility-Wide Emissions of TACs - AQMD Test Data
Exide Technologies
Vernon, CA

Chemical Name	CAS #	Max Hourly Emission Rate	Max Hourly Emission Rate	Annual Emission Rate	Annual Emission Rate
		lb/hr	g/s	lb/yr	g/s
Chromium VI	18540299	1.12E-04	1.42E-05	9.85E-01	1.42E-05
Chrysene	218019	1.09E-04	1.38E-05	9.59E-01	1.38E-05
Cobalt	7440484	1.24E-04	1.57E-05	1.09E+00	1.56E-05
Copper	7440508	2.72E-03	3.43E-04	2.37E+01	3.41E-04
Dibenz(a,h)anthracene	53703	4.22E-07	5.32E-08	3.70E-03	5.32E-08
Ethylbenzene	100414	1.13E-02	1.43E-03	9.92E+01	1.43E-03
Fluoranthene	206440	6.85E-04	8.63E-05	6.00E+00	8.63E-05
Fluorene	86737	5.40E-04	6.81E-05	4.73E+00	6.81E-05
Formaldehyde	50000	3.44E-02	4.34E-03	3.02E+02	4.34E-03
Hexachloro-1,3-Butadiene	87683	0	0	0	0
Hexane	110543	7.87E-07	9.92E-08	6.90E-03	9.92E-08
Indeno(1,2,3-cd)pyrene	193395	1.69E-07	2.13E-08	1.48E-03	2.13E-08
Lead	7439921	4.89E-02	6.16E-03	4.22E+02	6.08E-03
Manganese	7439965	6.70E-04	8.44E-05	5.82E+00	8.37E-05
Mercury	7439976	1.09E-03	1.37E-04	9.54E+00	1.37E-04
Methylene Chloride	75092	9.05E-04	0	7.93E+00	0
Methyl-t-Butyl Ether (MTBE)	1634044	0	0	0	0
Naphthalene	91203	3.02E-02	3.80E-03	2.64E+02	3.80E-03
Nickel	7440020	8.91E-04	1.12E-04	7.76E+00	1.12E-04
Perylene	198550	0	0	0	0
Phenanthrene	85018	3.45E-03	4.34E-04	3.02E+01	4.34E-04
Phosphorus	7723140	2.79E-03	3.51E-04	2.43E+01	3.50E-04
Pyrene	129000	3.74E-04	4.72E-05	3.28E+00	4.72E-05
Selenium	7782492	1.43E-04	1.80E-05	1.24E+00	1.79E-05
Silver	7440224	8.60E-05	1.08E-05	7.53E-01	1.08E-05
Styrene	100425	1.26E-01	1.59E-02	1.10E+03	1.59E-02
TEQ (Min) as 2,3,7,8-TCDD	1086	8.49E-10	1.07E-10	7.44E-06	1.07E-10
Tetrachloroethene	127184	2.63E-03	3.31E-04	2.30E+01	3.31E-04
Thallium	7440280	3.12E-05	3.93E-06	2.73E-01	3.93E-06
Toluene	108883	8.33E-02	1.05E-02	7.30E+02	1.05E-02
Total PAHs (excl.Naphthalene)	1151	1.25E-08	1.57E-09	1.09E-04	1.57E-09
Total PCBs, as MonoCB	1336363	8.56E-04	1.08E-04	7.50E+00	1.08E-04
Trichloroethene	79016	2.28E-03	2.87E-04	2.00E+01	2.87E-04
Trichlorofluoro methane	75694	0	0	0	0
Vanadium	7440622	1.29E-04	1.62E-05	1.13E+00	1.62E-05
Vinyl Acetate	108054	1.77E-01	2.23E-02	1.55E+03	2.23E-02
Vinyl Chloride	75014	2.80E-04	3.53E-05	2.45E+00	3.53E-05
Xylenes	1330207	3.26E-02	4.11E-03	2.86E+02	4.11E-03
Zinc	7440666	7.70E-03	9.70E-04	6.72E+01	9.66E-04

P:\E\Exide\HRA 2012 UPDATE\RRP_Revision_Nov2013\for HARP-Nov2013-RRP-current upper district.xlsx\TB.d-3_total

Note:

lb/hr = pounds per hour; lb/yr = pounds per year; g/s = grams per second

Figures

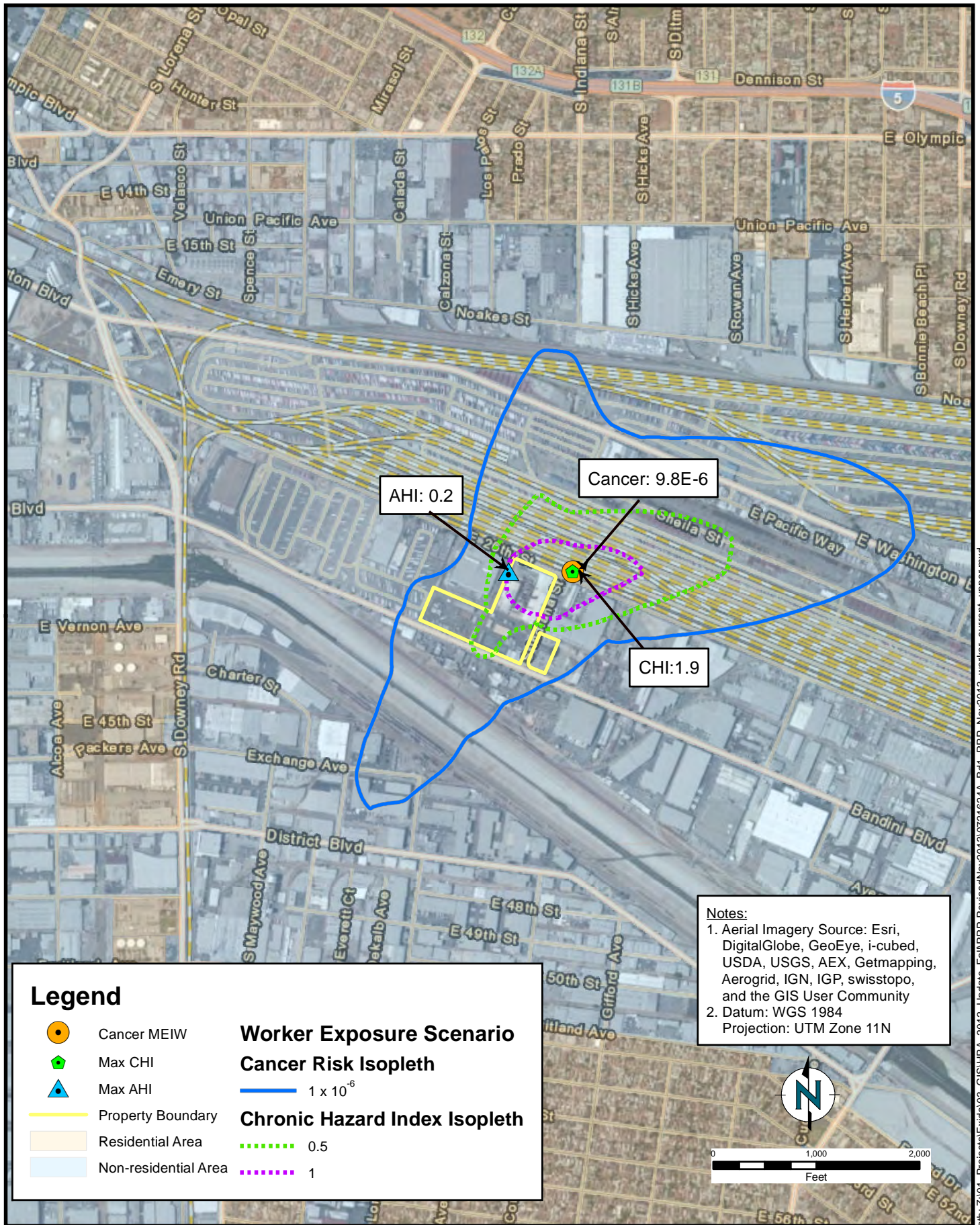

Legend

- Cancer MEIW
- Max CHI
- Max AHI
- Property Boundary
- Residential Area
- Non-residential Area

Worker Exposure Scenario

Cancer Risk Isopleth

1×10^{-6}

Chronic Hazard Index Isopleth

0.5

1

Notes:
 1. Aerial Imagery Source: Esri, DigitalGlobe, GeoEye, i-cubed, USDA, USGS, AEX, Getmapping, Aerogrid, IGN, IGP, swisstopo, and the GIS User Community
 2. Datum: WGS 1984
 Projection: UTM Zone 11N

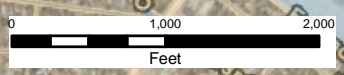

Path: Z:\01_Projects\Exide\03_GIS\HRA_2012_Update_Fall\RRP-Revised\Nov2013\0721624A_Bd1_RRP_Nov2013_worker_current_upper.mxd



Worker Exposure Risks
 - AQMD Test Data
 Exide Technologies
 2700 South Indiana Street, Vernon, CA

Figure
B.d-1

UPDATED BY: XZLiu

DATE: 11/20/2013

PROJECT: 07-21624A

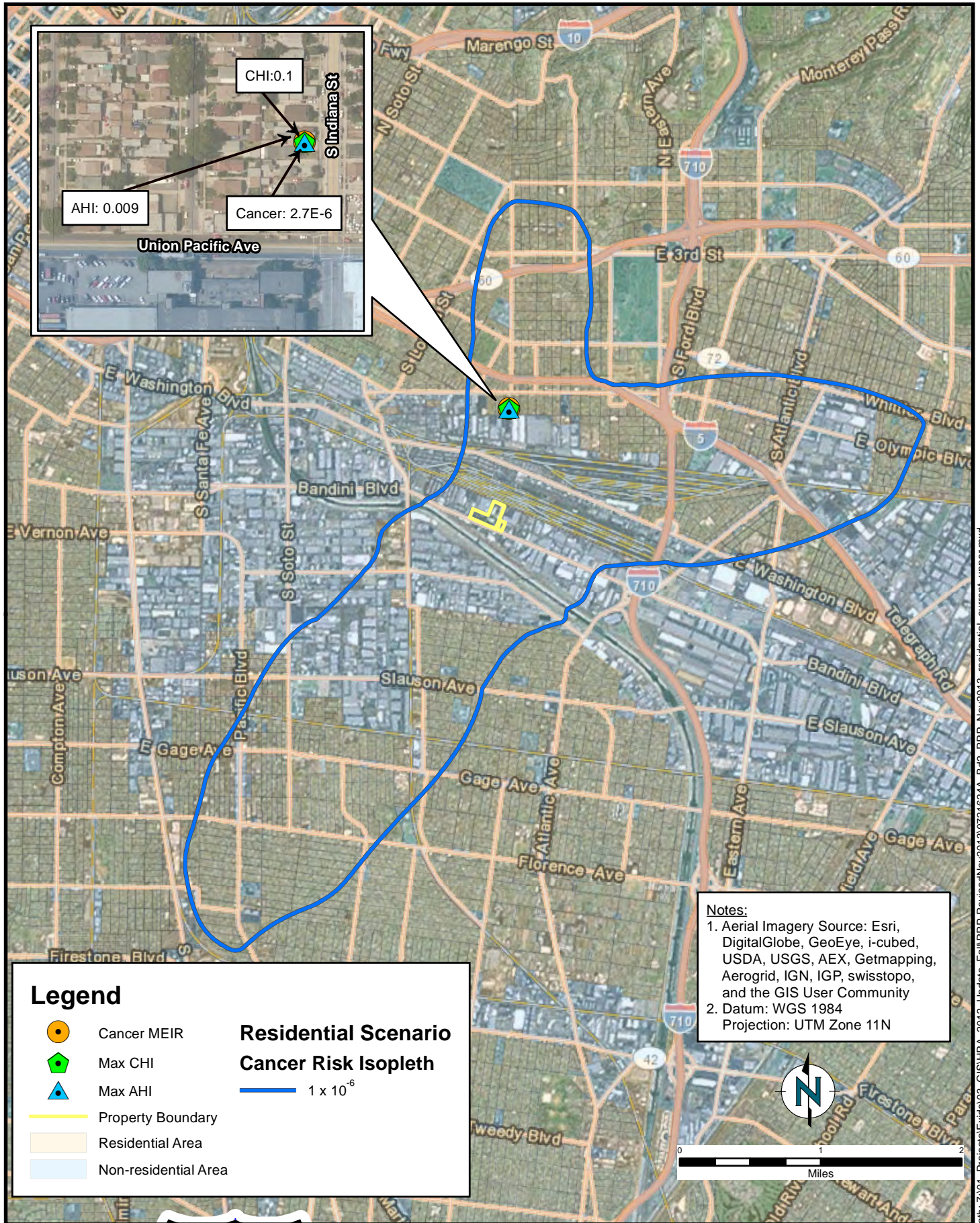

Path: Z:\01_Projects\Exide\03_GIS\HRA_2012_Update_Fall\RRP-Revised\Nov2013\0721624A_Bd2_RRP_Nov2013_residential_current_upper.mxd

Appendix C
Feasibility Study – SCAQMD Rule 1420.1(o)



Feasibility Study
SCAQMD Rule 1420.1(o)

Prepared for:
Exide Technologies
Vernon, California

Prepared by:
ENVIRON International Corporation
Irvine and Los Angeles, California

Date:
August 2011

Project Number:
07-26544A

Contents

	Page
1 Executive Summary	1
2 Introduction	2
2.1 Facility Location	2
2.2 Process Description	2
2.3 Rule 1420.1 Requirements	2
2.4 Ambient Air Quality Monitoring Results	3
3 Feasibility Study Requirements	4
3.1 Current Facility-wide Pb Emission Rate	4
3.2 Characterization of Pb Emission Sources at Exide (Vernon)	4
3.2.1 Process Source Emissions	5
3.2.2 General Ventilation Source Emissions	6
3.2.3 Consideration of Control Options for Process Sources and General Ventilation	6
3.3 Technical Feasibility	6
3.3.1 Determining the Technological Process Source Control Options to Achieve a 0.003 lbs/hr Facility-wide Pb Emission Rate	6
3.3.2 HEPA Filtration	7
3.3.3 WESP as a Process Source Control	8
3.3.4 Fugitive Emission Filtration Units as a General Ventilation Source Control	9
3.3.5 Addressing the Technical Feasibility of WESP and FEF Units	10
3.4 Economic Feasibility of Achieving a 0.003 lbs/hr Facility-wide Pb Emission Rate	11
3.5 Physical Feasibility of Achieving a 0.003 lbs/hr Facility-wide Pb Emission Rate	12
4 Ambient Air Quality Modeling	14
4.1 SCAQMD Modeling Efforts	14
4.2 Exide Modeling Efforts	14
5 Conclusions	17

List of Tables

Table 1.	Current Facility-wide Pb Emission Rates	4
Table 2.	Currently Permitted Control Equipment at Exide	5
Table 3.	WESP Design Parameters	9
Table 4.	BUSCH FEF Parameters	10
Table 5.	Cost Effectiveness Comparison	11
Table 6.	Source Parameters of AERMOD Runs	15
Table 7.	Lead Concentrations at the Monitors Predicted by AERMOD	15

Contents (continued)

List of Figures

- Figure 1. Site Vicinity Map
- Figure 2. Site Plot Plan
- Figure 3. Locations of Sensitive Receptors
- Figure 4. Site Plot Plan Showing WESP Footprint

List of Appendices

- Appendix A. ENVITECH WESP Proposal to Exide Technologies
- Appendix B. BUSCH FEF Statement
- Appendix C. EPA Draft Cost Impacts for the Secondary Lead Smelting Source Category, including Data Tables
- Appendix D. BUSCH FEF-50 Quote
- Appendix E. EPA's Draft Summary of the Technology Review for the Secondary Lead Smelting Source Category
- Appendix F. HB3151-25 Excess Emissions Calculation

p:\exide\1420.1-compliance plan-2011_\feasstudy\exide 1420-1 feasibility study.docx

1 Executive Summary

Exide Technologies, Inc. (Exide) has commissioned this Feasibility Study to comply with SCAQMD Rule 1420.1(o), which requires Exide to evaluate the technical, economic and physical feasibility of achieving a total Pb emission rate of 0.003 lbs/hour from all point sources if emissions are above $0.12 \mu\text{g}/\text{m}^3$ averaged over any 30 consecutive days. We assessed available emission control technologies in order to identify the most cost-effective and efficient technology, or combination of technologies, that could potentially achieve a facility-wide 0.003 lb/hr lead stack emission level.

We considered the following technologies for process source controls: (a) fabric filtration, (b) cartridge collectors, (c) HEPA filters as secondary filtration, and (d) Wet Electrostatic Precipitation (WESP). We also considered Fugitive Emission Filtration (FEF) Units (which include inherent secondary HEPA filtration) as a general ventilation control. Exide already widely employs several of these technologies, and thus appropriately analyzed in detail the two technologies it does not employ, namely the WESP and the FEF Units. After a rigorous analysis, we conclude that neither of the technologies is technically feasible to achieve the 0.003 lbs/hr emission level with any reasonable degree of confidence or with vendor guarantees of performance at such low levels.

In addition, we conclude that none of the technologies are economically feasible. Exide is currently achieving emissions rates below the currently required 0.045 lbs/hr -- a 99% point source reduction. As set forth in its Compliance Plan, by implementing certain point source and fugitive reduction measures, Exide reasonably expects to comply with the National Ambient Air Quality Standard (NAAQS) and Rule 1420.1(d)(2) by January 1, 2012. Even assuming that a combination of technologies might achieve 0.003 lb/hr on a facility-wide basis, it is not reasonably necessary to require Exide to further reduce the mass emissions rate to a level that cannot be guaranteed at a total economically infeasible capital cost of over \$30 million, or an incremental cost of over \$6 million per ton.

Moreover, the facility's space constraints are such that it is not physically feasible to accommodate the potential control technologies within the footprint of the facility.

This Study includes dispersion modeling demonstrating that stack emission control measures already specified in Rule 1420.1 are adequate to attain the $0.15 \mu\text{g}/\text{m}^3$ ambient lead concentration limit. With stack emissions effectively controlled, if additional control measures are necessary to reduce ambient lead concentrations, those measures should be directed toward fugitive emissions reduction.

2 Introduction

2.1 Facility Location

The Exide facility (SCAQMD ID # 124838) is located at 2700 South Indiana Street, Vernon, California. Exide is a secondary lead smelter that recycles lead batteries and other lead-bearing scrap materials. Figure 1 shows the facility and its vicinity. The land use in the immediate vicinity (up to 1.5 kilometers [km] radius) of the facility is industrial and the topography around the facility is primarily flat. The facility's layout showing the locations of the various buildings and the stacks are presented on Figure 2. The nearest residential areas are located approximately 1 km northeast and south of the facility as shown on Figure 3.

2.2 Process Description

Spent lead-acid batteries and other lead-bearing scrap materials are delivered to the facility by trucks, where the batteries and scraps are crushed, separated, and smelted to recover lead and propylene.

The spent lead-acid batteries and lead-bearing scrap are first broken apart and separated into the plastic, lead, and acid components. The plastic is recovered, and the acid is sent to a holding tank. The lead-containing components are transferred into one of the feed rooms, where they are then fed by conveyor to either the Reverberatory (Reverb) furnace (device D119) or the Blast furnace (D128), which are each used to heat the lead until it reaches a molten state.

The lead refining kettles are used to purify the hot, molten lead that is produced during the smelting process. Each kettle sits inside a brick-lined pit, housing natural gas-fired burners. The burners heat the air between the burners and the kettle, thereby heating the kettle. The kettles are continuously heated; however, there are usually only two or three kettles that contain material at any one time. The molten lead in the kettles is repeatedly heated, agitated with a mixer, and allowed to cool, with periodic stirring and additions of refining agents.

The refined lead is then formed into ingots, which are subsequently transferred to the Finished Lead Storage Building.

2.3 Rule 1420.1 Requirements

On November 12, 2008, the United States EPA published the Final Rule in the Federal Register revising the NAAQS from $1.5 \mu\text{g}/\text{m}^3$ to $0.15 \mu\text{g}/\text{m}^3$ measured over a three-month rolling average.

On November 5, 2010, the SCAQMD Governing Board adopted Rule 1420.1 (Emissions Standards for Lead from Large Lead-Acid Battery Recycling Facilities). Rule 1420.1(d)(2) prohibits a covered facility from discharging lead emissions exceeding $0.15 \mu\text{g}/\text{m}^3$ averaged over any 30 consecutive days. The Rule requires covered facilities to implement certain practices and emission control measures to attain the Lead NAAQS and Rule 1420.1(d)(2) standards after January 1, 2012.

Pursuant to Rule 1420.1(o), starting on July 1, 2011, if the facility discharges lead emissions that exceed $0.12 \mu\text{g}/\text{m}^3$ averaged over any 30 consecutive days, the facility shall submit to the SCAQMD a Feasibility Study that addresses the technical, economic and physical feasibility of achieving a total facility mass lead emission rate of 0.003 pounds per hour from all lead point sources.

2.4 Ambient Air Quality Monitoring Results

Monitoring results indicate that on July 30, 2011 the 30-day average ambient concentration at the facility's North, Northeast, and MID monitors exceeded $0.12 \mu\text{g}/\text{m}^3$. Therefore, Exide is submitting this Feasibility Study to fulfill the requirements of Rule 1420.1(o). However, as stated in Exide's Compliance Plan submitted in conjunction with this Feasibility Study, many control measures remain in the progress of being implemented and were not completed by the July 30, 2011 trigger date to meet the $0.12 \mu\text{g}/\text{m}^3$ limit. Exide reasonably believes that it would not have been required to submit this Feasibility Study had all measures (including multiple voluntary "early action" measures) been in place and operational as of July 1, 2011.

3 Feasibility Study Requirements

Rule 1420.1(o) requires that the Feasibility Study address the following elements in determining whether the facility can achieve a total Pb emission rate of 0.003 lbs/hour from all stationary sources:

- Technical feasibility,
- Economic feasibility, and
- Physical feasibility

A discussion of each of these elements is provided in the following sections.

3.1 Current Facility-wide Pb Emission Rate

Table 1 summarizes emissions rates from all Pb point sources from Exide's most recent source tests. The results indicate that the total facility Pb emission rate from all point sources is less than the 0.045 lbs/hr limit established by Rule 1420.1(f)(2).

Table 1 Current Facility-wide Pb Emission Rates

APC#	AQMD Device#	Control Device Description	Area Served	Source Test Date	Source Test Measured (dscfm)	Pb Emissions (lb/hr)
10	C38	North Torit	General Ventilation	10/2010	94,599	0.00141
11	C39	South Torit	General Ventilation	1/4 - 6/2011	110,126	0.0036
13	C156/C157	MAC BHs	GV: RMPS, Kettle Burners, Reverb Feed	12/27/2010	103,920	0.000572
7	C48	Material Handling BH	GV: Material Handling & Blast Feed Room	10/12/2010	95,858	0.00115
9	C165/C172	RMPS MAPCO Demister / HEPA	RMPS	11/10 -12/2010	17,270	0.000358
12	C144/C143	Kiln Dryer BH / Cyclone	Kiln (Rotary Dryer)	9/14/2010	10,392	0.0105
S1	C42/C43	Neptune-Venturi Scrubber	Blast & Reverb furnaces	9/8/2010	18,059	0.000175
5	C46	Hard Lead BH	Hard Lead	10/4,5,7/2010	101,832	0.00102
6	C47	Soft Lead BH	Soft Lead	10/2010	85,435	0.000851
Total					637,491	0.020
						<0.045 limit

While the Pb emission rate from all point sources is more than 50% less than the 0.045 lbs/hr limit, the rate is greater than the 0.003 lbs/hr rate that is the "target level" for this Feasibility Study.

3.2 Characterization of Pb Emission Sources at Exide (Vernon)

There are two general categories of point sources of Pb emissions at the Exide (Vernon) facility. The first source comes from Process Source emissions. The second source comes from

General Ventilation emissions. As of July 1, 2011 Exide had the following air pollution control devices installed for reducing Pb emissions from a variety of sources.

Table 2 Currently Permitted Control Equipment at Exide

Control Device Description	Equipment/Area Controlled
Process Emission Sources	
C40 – baghouse; C41 – baghouse;	Reverb furnace (D119)
C44 – afterburner; C45 – baghouse	Blast furnace (D128)
C42 – venturi scrubber; C43 – tray scrubber; S139 – stack	APC 1 (C40, C41), APC 2 (C44, C45)
Hard Lead baghouse	Lead refining kettles and dross hoppers (D7 – D20), Blast furnace tapping ports and launders (D129 – D134), rotary dryer furnace enclosure (C177)
Soft Lead baghouse	Lead refining kettles and dross hoppers (D24 – D37), Reverb furnace feeders (D117, D118), Reverb furnace tapping ports and launders (D120 – D125), fugitive emissions from Quench Chamber cleanout door (D149)
C143 – cyclone; C144 – baghouse; S145 – stack	Rotary dryer furnace (D115) and screw conveyors (D114, D116)
General Ventilation Sources	
North Torit baghouse	Fugitive emissions from the Smelting and Refining building, fugitive emissions from the Baghouse Row building
South Torit baghouse	Fugitive emissions from the Smelting and Refining building, fugitive emissions from the Baghouse Row building
C156, C157 – MAC baghouses; S158 – stack	RMPS building (C175), lead refining kettle burner stack emissions, rotary dryer hoppers (D109, D110) and conveyors (D111 – D113), South Corridor building (C182)
C159 – cyclone; C160 – baghouse	Fugitive emissions in Blast Furnace Feed Room
Material Handling baghouse	Central Vacuum System A (C159, C160), Central Vacuum System B (C162, C163), Blast Furnace feed hopper (D126)
C165 – packed bed scrubber; C172 – HEPA filter; S166 – stack	Raw Material Preparation System (RMPS) building (C175), Hammermill (D1), Hammermill feed conveyor (D2), Mud holding tanks (D3 – D5)
C162 – cyclone; C163 – baghouse	Fugitive emissions in Blast Furnace Feed Room

3.2.1 Process Source Emissions

Process Source emissions consist of the exhaust from the Rotary Dryer, Blast & Reverb Furnaces, and the Hard & Soft Lead Baghouses. Pb emissions come directly from the feed material processed in these furnaces. The Pb emissions in the exhaust from the furnaces are

controlled by baghouses and subsequently by a wet scrubber prior to discharge to the atmosphere.

The data in Table 1 shows that the total stack exhaust from these sources is approximately 215,000 dscfm with a total Pb emission rate of 0.013 lbs/hr.

3.2.2 General Ventilation Source Emissions

General Ventilation emissions consist of room air that moves through building enclosures in order to meet the negative pressure specified by Rule 1420.1. The data in Table 1 shows that the total stack exhaust from these sources is approximately 400,000 dscfm with a total Pb emission rate of 0.007 lbs/hr.

3.2.3 Consideration of Control Options for Process Sources and General Ventilation

General Ventilation sources must process relatively large quantities of air as compared to the process units in order to meet the requirements for total enclosures. At Exide's Vernon plant, General Ventilation accounts for 65% of the total exhaust flow, but only 25% of the total Pb emissions.

As a result, control options were reviewed to account for the different characteristics of General Ventilation (higher exhaust volume, lower Pb loading) as compared to Process Emissions (lower exhaust volume, higher Pb loading).

3.3 Technical Feasibility

3.3.1 Determining the Technological Process Source Control Options to Achieve a 0.003 lbs/hr Facility-wide Pb Emission Rate

As a threshold matter, in order to assess the feasibility of achieving a 0.003 lbs/hr facility-wide emission rate, it is necessary to set forth the available technological process source control options. If no combinations of the available technologies are capable of meeting the 0.003 lbs/hr limit, then achieving that limit is not technically feasible.

This Feasibility Study builds upon EPA's extensive recent research on process source control technologies potentially applicable for improving lead stack emissions. EPA performed its research during the Risk and Technology Review (RTR) process for revising the National Emission Standards for Hazardous Air Pollutants (NESHAP) for lead smelters. This EPA effort culminated in a Proposed Rule that revised the NESHAP for Secondary Lead Smelting published on May 19, 2011 [76 FR 97]. The rulemaking record includes EPA's Draft Summary of the Technology Review for the Secondary Lead Smelting Source Category [docket item EPA-HQ-OAR-2011-0344-0055] which is attached as Appendix E. In reviewing all the technologies deployed across the industry for the control of lead stack emissions currently and recent developments in those technologies, EPA identified the suite of potential control technologies to include the following.

- Fabric filtration (baghouses of various types and cloth media)
- Cartridge collectors

- HEPA filters as add-on secondary filtration subsequent to fabric filters or cartridge collectors
- Wet Electrostatic Precipitation (WESP)

EPA not only considered the technologies currently applied in this industry but also, “technologies employed by similar industries, and reviewed new or updated NESHAPs for other source categories.” [EPA docket item 0055, page 4] We concur with this evaluation and are aware of no other available cost-effective emission control technologies. Thus, this Feasibility Study appropriately evaluates the four EPA-recognized process-source control technologies.

Of the EPA technologies, Exide already employs fabric filtration, with the highest quality polytetrafluoroethylene (PTFE) membrane-type filter bags, and two cartridge collectors. Additionally, Exide has installed secondary HEPA filtration on the battery breaker scrubber, rotary dryer baghouse, and the facility’s two cartridge collectors, though the degree of improvement resulting from the installations on the rotary dryer baghouse and cartridge collectors is not yet known pending emission testing.

With fabric filtration and HEPA cartridges already installed, we herein examine the two remaining EPA-identified process control technological approaches for improving the facility’s lead stack emissions, namely, (i) the wider deployment of secondary HEPA filtration and (ii) Wet Electrostatic Precipitation (WESP). These measures are considered in the following Sections.

3.3.2 HEPA Filtration

Of the two remaining EPA-identified process control options, the most cost-effective is wider deployment of secondary HEPA filtration. The degree of emission reduction that can be achieved by HEPA filters on this industry’s stack emissions is unclear and expectations vary widely. While HEPA filters are rated by definition to filter 99.97% of particles at a 3 micron size, it is not appropriate to assume or estimate that placing a HEPA filter downstream of a fabric filter or cartridge collector will reduce lead emissions by a further 99.97%. This is because some relatively significant fraction of the lead emissions exiting a fabric filter will be in the “condensable” size range, that is, material that passes through the filter in the stack testing apparatus and subsequently caught in the wet impingers in the test train. Material small enough to pass through the stack testing filter is also small enough to pass through a HEPA filter. EPA, for example, found in its analysis of the industry’s emission data that “HEPA filters used downstream of a baghouse achieve approximately 20 percent lower outlet concentrations than baghouses alone.” [EPA docket item 0055, page 5]. The District established a higher range of expectation in its calculation of the expected improvement from installing HEPA filters downstream of the Exide Vernon facility’s cartridge collectors. The District estimated that such installation would reduce lead emissions by 70.8% and result in outlet lead concentrations downstream of the HEPA filters of 2.715 µg/dscm [see document “HB3151-25 Excess Emissions“ from Case 3151-25, attached as Appendix F]. Thus, taking the District’s calculations at face value, the range of potential improvement by installation of HEPA filtration is 20 to 71%.

Preliminarily, we consider the installation of HEPA filtration downstream of all sources at the Exide Vernon facility. Per the tabulation in Table 1, total exhaust flow is 637,491 dscfm with current actual facility-wide lead emissions of 0.02 lb/hr vs. 0.045 lb/hr allowed. On a mass

basis, even assuming the highest end of the expected range of improvement (71%) due to HEPA installation, facility wide emissions would be $0.02 \times (1-0.71) = 0.0058$ lb/hr, which is double the 0.003 lb/hr target level for this study. A 71% reduction in the 0.045 lb/hr allowable emission rate would be 0.013 lb/hr, or more than four times the 0.003 lb/hr target. Alternatively, assessing the issue from a concentration basis, the District's 2.715 $\mu\text{g}/\text{dscm}$ expected lead concentration downstream of HEPA filtration, if applied to the total facility-wide flow of 637,491 dscfm, would result in facility-wide lead emissions of 0.0065 lb/hr, which is more than twice the target of this Feasibility Study.

In summary, secondary HEPA filtration, even using the high end of expected improvement, still falls well short of the 0.003 lb/hr target for this study. At any other lower degree of HEPA improvement, the gap between the result and 0.003 lb/hr is even wider. In addition, HEPA filtration is not suitable for installation on the hot and moist exhaust gas flow from the facility's direct furnace metallurgical exhaust (Neptune Scrubber), though we included that source in the above evaluation in order to be conservative.

HEPA filtration alone is insufficient to approach 0.003 lb/hr on a facility-wide basis. In particular, in the sections to follow we have considered the most cost-effective combination which would employ WESP to those sources least amenable to HEPA filtration (the process sources) and to enough of the flow from the facility to potentially bring the overall total emission rate under 0.003 lb/hr.

The following two sections (3.3.3 and 3.3.4) introduce both a Process Source Control option (WESP) and a General Ventilation Source Control Option (Fugitive Emission Filtration). Thereafter, Sections 3.3.5, 3.4, and 3.5 address whether these options are technically, economically and physically feasible means of achieving a 0.003 pounds per hour total facility mass emissions rate.

3.3.3 WESP as a Process Source Control

Exide is currently controlling emissions from the blast furnace, reverb furnace, direct hooding serving those furnaces (the hard and soft lead ventilation systems, and the rotary dryer are process sources) using baghouses equipped with polytetrafluoroethylene membrane-type filter bags. Exide fitted the Rotary Dryer Baghouse with secondary HEPA filtration on June 30, 2011. The emission rate for this unit given in Table 1 does not include the degree of improvement from this secondary filtration installation as testing has not yet been completed. Exhaust from the direct blast and reverb furnace is further currently controlled by a wet scrubber downstream of their respective baghouses. For additional reducing Pb emissions from these Process Sources, Exide considered a Wet Electrostatic Precipitator (WESP) as a secondary control option as this is the only technology identified with the potential to achieve emission rates as low as that targeted by this Feasibility Study.

Exide provided process data such as flow rate, Pb loading, moisture content, and exhaust temperature to Envitech so that Envitech could provide Exide a proposal for reducing emissions from Process Sources. Envitech was the vendor that supplied the only WESP currently installed at a secondary lead smelting facility. In a June 16, 2011 e-mail from Andy Bartocci to Russell Kemp, Envitech recommended that "the non-process ventilation sources be treated by another means due to the large volumetric flow rate." Based on Envitech's analysis of the

operating conditions at Exide’s Vernon plant, Envitech provided the following proposed design for control of the process source subset.

In addition, an estimate of the annual operating cost of the WESPs is tabulated below. This estimate can be found in the Cost Impacts analysis tables for Secondary Lead NESHAP Docket Item EPA-HQ-OAR-2011-0344-0040.1 (Proposal May 19, 2011). A copy of US EPA’s Cost analysis and data tables is included in Appendix C. US EPA also provided an estimate of the installed cost for a WESP that was in good agreement with the cost estimate provided by Envitech.

Table 3 WESP Design Parameters

Parameter	Existing Configuration	Proposed Design
Stack Flow (dscfm)	215,879	215,879
Pb Concentration (gr/dscf)	1.1E-6 to 8.5E-6	2.7E-7 to 4.9E-7
Pb Rate (lbs/hr)	0.014	0.001
Installed Cost	N/A	\$30,000,000-Envitech \$33,000,000-USEPA
Annual Operating Cost	N/A	\$712,500 – Envitech, verbal \$1,650,000-USEPA
Footprint (sq. ft)	N/A	7,500

The Envitech proposal calls for two (2) trains of five (5) WESPs each, for a total of ten (10) WESPs. Envitech’s proposal is included in Appendix A. Each train would handle half of the combined gas flow from these sources and would have one stack and two induced draft fans.

3.3.4 Fugitive Emission Filtration Units as a General Ventilation Source Control

Baghouses control fugitive emissions from Material Handling operations, Feed Rooms, and Raw Material areas. General ventilation sources are controlled using cartridge collectors (Torits). The addition of the HEPA after-filters for the Torits was completed in August 2011. Test data to indicate performance subsequent to this addition are not yet available. Based on the large volumetric flow rate from these general ventilation sources, Envitech recommended that a non-WESP option be considered for secondary control of these sources.

For technology with the potential to improve control of the General Ventilation Sources, Exide investigated Busch International Fugitive Emission Filtration (FEF) Units. These units are specially designed to reduce particulates contained in fugitive emissions and general ventilation sources that typically have relatively low particulate loadings when compared to the particulate loading found in process source exhaust. Busch FEF units have integral secondary HEPA filtration as an option and this configuration is the one pursued for this study. Based upon a review of industry data, and specifically of the lead emission concentrations achieved at the Quemetco facility (also in South Coast), Busch FEF units are achieving, in practice, exhaust lead concentration levels among the lowest in the industry. These units are not, however, amenable to installation on the process sources.

Exide provided general ventilation source data such as flow rate, Pb loading, moisture content, and exhaust temperature to Busch International so that they could provide a proposal for reducing emissions from General Ventilation Sources. Based on Busch’s analysis of the operating conditions at Exide’s Vernon plant, Busch was not able to propose a design or extend any performance guarantees for reductions in emissions below the low levels already being

achieved by the existing filtration equipment at the facility. A copy of their letter is included with this report and is found in Appendix B. That is, based on the wide range of potential improvement (possibly as little as 20%, per EPA as cited above), Busch could not guarantee any improvement.

The largest unit that Busch manufactures is FEF-50, which can handle 50,000 scfm of exhaust gas. Given that Exide has approximately 400,000 scfm of total exhaust from General Ventilation sources, Exide would need a minimum of eight (8) FEF-50 units. Exide received a quote from Busch for a single FEF-50 which is included in Appendix D. In order to continually process this exhaust stream, Exide would need to purchase additional units to remain on standby.

Table 4 BUSCH FEF Parameters

Parameter	Existing Configuration	Proposed Design
Stack Flow (dscfm)	401,777	401,777
Pb Concentration (gr/dscf)	2.2E-6 to 10.1E-6	2.2E-6 to 10.1E-6
Pb Rate (lbs/hr)	0.007	0.007
Installed Cost	N/A	\$2,400,000
Annual Operating Cost	N/A	Operating costs not expected to be significantly higher or different than that being currently experienced with the existing control devices.
Footprint (sq. ft)	N/A	2,880 – 4,200

3.3.5 Addressing the Technical Feasibility of WESP and FEF Units

In order to assess the technical feasibility of achieving a 0.003 lbs/hr facility-wide emissions rate, it is necessary to look at all secondary control options as a whole. Based on the assessments provided by Envitech for using WESPs to control Process Sources and Busch International for using FEF HEPA Units to control General Ventilation Sources, it is not technically feasible to achieve a facility-wide Pb emission rate of 0.003 lbs/hr.

A key element of technical feasibility is the ability to craft engineering performance specifications in line with the target emission goal and have vendors guarantee performance consistent with such specifications. Through exchanges with Busch International, we have been unable to secure the necessary guarantees for performance that, when combined with WESP exhaust performance for the process sources, would meet a facility-wide point source Pb emission rate of 0.003 lb/hr. It is possible that such a combined installation (WESP on process sources, HEPA on all others) could achieve emissions in the vicinity of 0.003 lb/hr, but such performance could not be reasonably expected on a repeatable basis nor backed by vendor guarantees. While this particular combined configuration is employed by Quemetco, the Exide Vernon facility is exhausting much more air – the fundamental reason that a 0.003 lb/hr lead emission level cannot be expected even when using the same technologies. From a performance guarantee perspective, it is conceivable that the application of WESP to the entire facility flow could result in a facility-wide emission level guarantee below 0.003 lb/hr but such facility-wide application of the WESP technology was not the recommendation of the WESP vendor which recommends consideration of that technology to address the specific challenges of process gases having the potential to contain ultrafine particulate condensed from gaseous metals. Costs to deploy WESP technology facility-wide would be well more than double those assessed for economic feasibility in Section 3.4 below.

3.4 Economic Feasibility of Achieving a 0.003 lbs/hr Facility-wide Pb Emission Rate

In performing the economic assessment, it is necessary to consider the economics of the entire suite of control options. A particular secondary control option may be economically feasible on its own but may not be sufficient on its own to achieve a facility-wide emission rate of 0.003 lbs/hr. All options must be evaluated as a total package in completing the environmental assessment.

Table 5 shows the cost comparison for the WESP and BUSCH units combined. For comparison, we also show the Cost Analysis for the WESP technology only that was provided by USEPA for the NESHAP Risk and Technology Review found in Appendix C. This column is for the deployment of the WESP for the industry as a whole.

Table 5 Cost Effectiveness Comparison

Parameter	Exide	EPA NESHAP (4)
Capital Costs		
WESP (1)	\$30,000,000	\$400,000,000
Busch	\$2,400,000	n/a
Subtotal	\$32,400,000	\$400,000,000
Annualized Capital Cost		
WESP	\$3,000,000	\$36,000,000
Busch	\$240,000	n/a
Subtotal	\$3,240,000	\$36,000,000
Annual Operating Costs		
WESP (2)(3)	\$712,500	\$9,500,000
Busch	\$0	n/a
Subtotal	\$712,500	\$9,500,000
Total Annualized Costs		
WESP	\$3,712,500	\$45,500,000
Busch	\$240,000	n/a
Subtotal	\$3,952,500	\$45,500,000
Total Pb Reductions		
lbs/yr	1,140	
tons/yr	0.57	13.8
Cost per Ton Pb Reduction		
\$/ton Pb Removed		
Exide-(WESP + Busch) / EPA-WESP	\$6,900,000	\$3,300,000
Exide-(WESP) / EPA-WESP	\$6,500,000	\$3,300,000
(1) In EPA's draft Residual Risk MACT docket, their estimate for the Capital Cost of a WESP for the Vernon facility was \$33,000,000. See docket item 0040.1. (2) EPA's estimate for Annual Operating Costs was \$19,000,000. In discussions with Andy Bartocci of Envitech, we understand that EPA may have included the RTO in the costs. Accordingly, we have reduced the EPA's operating cost estimate by 50%. (3) Exide Annual Operating Costs are estimated as the ratio of the EPA's Operating Cost to Capital Cost. (4) Note, Capital and Operating costs in this column for the EPA NESHAP study are for aggregate costs on an industry-wide basis to deploy the WESP technology at 13 facilities.		

The SCAQMD adopted Rule 1420.1 in order to bring the SCAQMD into compliance with the revised federal NAAQS for lead. Other than assessing annual compliance cost, SCAQMD did not perform a cost-effectiveness analysis for the Rule. In adopting the Rule, SCAQMD required a facility mass emissions rate of 0.045 lbs/hr, which, combined with other Rule measures and

voluntary compliance measures to address fugitive emissions, was found sufficient to achieve the NAAQS. The 0.045 lbs/hr number represents a 99% point source reduction, and further reductions are not economically reasonable or feasible.

EPA has also evaluated the cost effectiveness of the WESP technology (the larger cost element in the above tabulation) as part of the proposal for revisions to the National Emission Standards for Hazardous Air Pollutants (NESHAP) for Secondary Lead Smelting [76 FR 97, May 19, 2011]. EPA's estimated capital cost for installation of a WESP at the Exide Vernon facility was \$33 million which is very near the \$30 million quoted by Envitech. EPA estimates the cost effectiveness as \$3.3 million per ton of reductions in metal HAP emissions (mainly lead compounds).

EPA concluded that these costs were too high to warrant adoption of WESP technology as a NESHAP component, specifically saying:

"...the costs for these additional controls are high. Therefore, we are not proposing a requirement for the installation of a WESP under this ample margin of safety analysis."

[76 FR 97, May 19, 2011 at page 29058]

As was stated in Section 3.3.4, the combination of WESP control for Process Sources and FEF controls for General Ventilation Sources was not technically feasible in achieving a 0.003 lbs/hr limit. In addition, the cost to reduce Pb using the technology reviewed in this study for the Vernon facility are more than double the cost that EPA determined to be too high, primarily because the emission performance currently at the Exide Vernon facility is already better than industry-wide typical performance. That is, deployment of the WESP technology at Exide Vernon would be even less cost effective than deployment for the industry as a whole, because there are fewer emissions to capture by such very expensive technology.

The data presented in this section demonstrate that this combination of controls is not economically feasible in achieving this emission rate. A key element of economic feasibility is also the ability of companies to deploy capital in ways that have certainty of outcome. As noted above, the controls for achieving the general ventilation emission reductions cannot be guaranteed by the vendor to achieve the target levels of reductions. The absence of such guarantees renders the commitment of such a large capital expenditure economically infeasible.

3.5 Physical Feasibility of Achieving a 0.003 lbs/hr Facility-wide Pb Emission Rate

A plot plan showing the configuration of the Exide Vernon facility is shown in Figure 4. This plot plan shows the configuration once the pending "Baghouse Row" enclosure is fully constructed. After this occurs all stationary sources of lead will be operating in total enclosures that will be vented to air pollution control devices.

In addition to the location of buildings, the plot plan also shows the fenceline and the space that would be available for installation of any secondary control devices. A WESP control configuration would consist of two (2) trains of five (5) WESPs each, for a total of ten (10) WESPs. This WESP configuration would occupy and require a footprint of 7,500 square feet.

Each Busch FEF unit has dimensions of 30 feet by 12 feet. The overall FEF footprint for 8 units would be at least 65 feet by 65 feet or 4,225 square feet.

Figure 4 shows the plot plan with the footprint of two trains of five WESPs and eight FEF units superimposed on it. As the graphic shows, there is very little land area available in which to construct and operate the WESPs and FEF units on site. The location indicated on the figure for these installations blocks access to key operations and would not allow the shipment of lead from the shipping warehouse at the northeast corner of the facility and recovered plastic from the north end of the RMPS building.

Additionally, the available land area is used for truck traffic and other operating equipment on site. As such the available “inactive” land area, space that is not currently used, is even smaller. There is not enough “inactive” land area available for locating two trains of five WESPs and eight FEF units.

Therefore, the data presented in this section demonstrate that this combination of controls is not physically feasible in achieving this target emission rate.

4 Ambient Air Quality Modeling

4.1 SCAQMD Modeling Efforts

In its review of Rule 1420.1, the SCAQMD's Stationary Source Committee (SSC) reviewed an ambient air quality modeling analysis performed by SCAQMD staff regarding lowering the facility-wide lead point source emission rate from 0.045 lbs/hr to 0.003 lbs/hr.

At the time that the SCAQMD conducted its modeling, Exide was conducting a series of source tests to collect up-to-date emissions data for use in updating its health risk assessments. The emission rates available to the SCAQMD was 1-2 years old and did not take into account the equipment improvements that had been made in the intervening time.

Nevertheless, even using this older emissions data, the SSC concluded that...

“the other lead-acid battery recycling facility (Exide) can achieve the new lead standard through controlling lead point source emissions to 0.045 lbs/hr and strict adherence to housekeeping provisions of PR 1420.1. At this point, there is not sufficient information to substantiate the need to require this facility (Exide) to go beyond an expected 99% point source reduction at an additional cost of \$15 to \$20 million.”

4.2 Exide Modeling Efforts

In order to confirm the SCAQMD's analysis and update the results using the most recent source test emissions data and the revisions to buildings and stacks, Exide conducted its own ambient air quality modeling. US EPA's AERMOD dispersion modeling runs were made for two scenarios to evaluate the impacts that the Pb reduction measures currently under construction would have on the ambient Pb concentrations measured at the monitors located at and around the fenceline of the Vernon facility. Inputs to AERMOD included:

- Pb emission rates (lbs/hr) from Point Sources
- Scenario 1: using the rates measured from source tests conducted in late 2010 and early 2011 at the facility;

Scenario 2: considering the control efficiencies of the Wet Electrostatic Precipitator (WESP) to be installed for Kiln Dryer Baghouse, Neptune-Venturi Scrubber, Hard Lead Baghouse, and Soft Lead Baghouse, and for HEPA Busch and HEPA Busch for North Torit, South Torit, MAC Baghouse, and Material Handling Baghouse upon the emission rates in Scenario 1.

- Building profile for the new “Baghouse Row” enclosure was used for scenarios 1 and 2;
- Stack heights for the North Torit, South Torit, and MAC Baghouse were increased from 79 feet to 120 feet for scenarios 1 and 2;
- Emissions from fugitive sources were set to zero for scenarios 1 and 2. Once the construction of the “Baghouse Row” building is completed, Pb emissions from fugitive sources will be vented to control devices and should not have any significant impacts, if any, at the ambient monitors.

Table 6 Source Parameters of AERMOD Runs

Source ID	UTM Coordinates (m)		Emission Rate (Scenario 1)	Emission Rate (Scenario 2)	Release Height	Temp	Velocity	Stack Diameter
	X	Y	(g/s)		(m)	(K)	(m/s)	(m)
MAPCO	389705.7	3763538	8.05E-05	8.05E-05	19.35	299.48	4.55	1.09
MAT_STOR	389722.7	3763488	1.18E-03	5.91E-05	34.14	300.93	14.14	2.13
SOFTLEAD	389750	3763554	8.38E-04	4.19E-05	34.14	318.15	14.10	2.03
HARDLEAD	389729.9	3763505	8.35E-04	4.18E-05	34.14	311.76	17.17	2.03
DRYER_BH	389769.8	3763525	1.32E-03	6.61E-05	36.6	375.22	7.47	0.91
NEPTUNE	389751.4	3763527	2.20E-05	1.10E-06	34.14	332.89	8.27	1.16
NOR_CART	389790.5	3763550	3.60E-04	1.80E-05	36.6	298.50	11.29	2.13
SOU_CART	389789.3	3763547	5.29E-04	2.65E-05	36.6	298.89	15.29	2.13
MAC_BH	389740.1	3763479	2.36E-04	1.18E-05	36.6	307.44	18.06	1.82
			0.0054	0.00035	g/s			
			0.043	0.003	lbs/hr			

The modeling results are summarized in Table 5.

Table 7 Lead Concentrations at the Monitors Predicted by AERMOD

Scenario #	Lead Concentrations ($\mu\text{g}/\text{m}^3$)						
	SW_Monitor	SE_Monitor	NE_Monitor	On-Site North	REHRIG	Railway	CP_Monitor
Scenario 1	0.00765	0.00338	0.0437	0.02403	0.04657	0.01339	0.0071
Scenario 2	0.00064	0.00091	0.00689	0.00348	0.00647	0.00134	0.00042

For these modeling runs, the emission rates were based on source tests from late 2010 through early 2011. Additional source testing has been in progress as part of the update for the AB2588 HRA. The emission rates that were used in this modeling did not reflect the improvements due to the recent modifications to the air pollution control equipment. The total facility-wide emission rate for all stationary sources used in the modeling was 0.043 lbs/hr. This is greater than the current actual 0.020 lbs/hr facility-wide rate when the most recent source tests are taken into account, but it is still less than the 0.045 lbs/hr limit set by the rule – indicating that the 0.045 lb/hr facility-wide point source limit established in the Rule is adequate to insure compliance with the ambient standards.

Thus, the modeling results presented in this Study reflect a worst case scenario when the Vernon plant is emitting lead at a rate just below the Rule limit. As the actual facility-wide emission rate is even less than the modeled rate, the ambient impacts would be less than what are reported here, by approximately a factor of two.

For Scenario #1 (consistent with the 0.045 lb/hr facility-wide allowable emission rate), the maximum predicted ambient concentration at a residential receptor is only $0.005 \mu\text{g}/\text{m}^3$ which is only 3 percent of the 0.15 standard. The maximum predicted ambient concentration at the maximum off-site receptor was only 0.08 which is only 50 percent of the 0.15 standard. That is, stack impacts from emissions consistent with the current 0.045 lb/hr emission level are already contributing less than half the $0.15 \mu\text{g}/\text{m}^3$ standard, and even less given that actual stack emissions are currently less than half the 0.045 lb/hr limit. Current actual and allowed stack

emission rates are not a hindrance to achieving $0.15 \mu\text{g}/\text{m}^3$ at the facility's ambient monitors and stack impacts at residences are essentially negligible.

The key point of this modeling exercise is to point out that it is not necessary to force the facility-wide lead stack emission rate to 0.003 lb/hr in order to achieve attainment of the NAAQS. Even with stack emissions from the facility just under the 0.045 lb/hr facility wide emission limit of Rule 1420.1, projected impacts are much less than one half of the $0.15 \mu\text{g}/\text{m}^3$ ambient level. Consideration of the feasibility of the 0.003 lb/hr facility-wide stack emission level can only be made in the context of the purpose of the rule from which this feasibility study was commissioned. In that context, this modeling demonstrates that additional stack emissions reductions are not expected to further reduce ambient lead concentrations. Should Exide not meet the $0.15 \mu\text{g}/\text{m}^3$ standard, resources should be directed to towards reducing fugitive emissions rather than stack emissions.

5 Conclusions

Based on the data presented in this study, no combination of Lead emission control technologies is currently available for which vendors will provide performance guarantees that can achieve a facility-wide emission rate of 0.003 lbs/hr from all point sources, thereby rendering such technologies technically infeasible. In addition, the technologies are not economically feasible because their installation would require capital expenditures in excess of \$30 million and annual operating expenses of nearly \$2 million, without expected contribution to the facility's ambient concentration compliance. Moreover, space constraints at the Vernon facility render installation of the technologies physically infeasible.

Exide's existing measures (some yet to be fully implemented) are sufficient to meet the Rule 1420.1 facility-wide emission rate requirement of 0.045 lbs/hr as well as attainment with the ambient Pb concentration limit of 0.15 $\mu\text{g}/\text{m}^3$. If for any reason Exide does not meet the ambient standards, in its Compliance Plan Exide has proposed to implement certain measures that are expected to further reduce emissions. Exide's Compliance Plan measures (both "early action" and contingent, as set forth in the Compliance Plan) are appropriately targeted towards fugitive emissions, which primarily drive ambient concentrations.

Accordingly, it is concluded that achieving a 0.003 lb/hr facility-wide lead emission rate level for the Exide facility in Vernon, California, is not technically, economically or physically feasible.

Figures

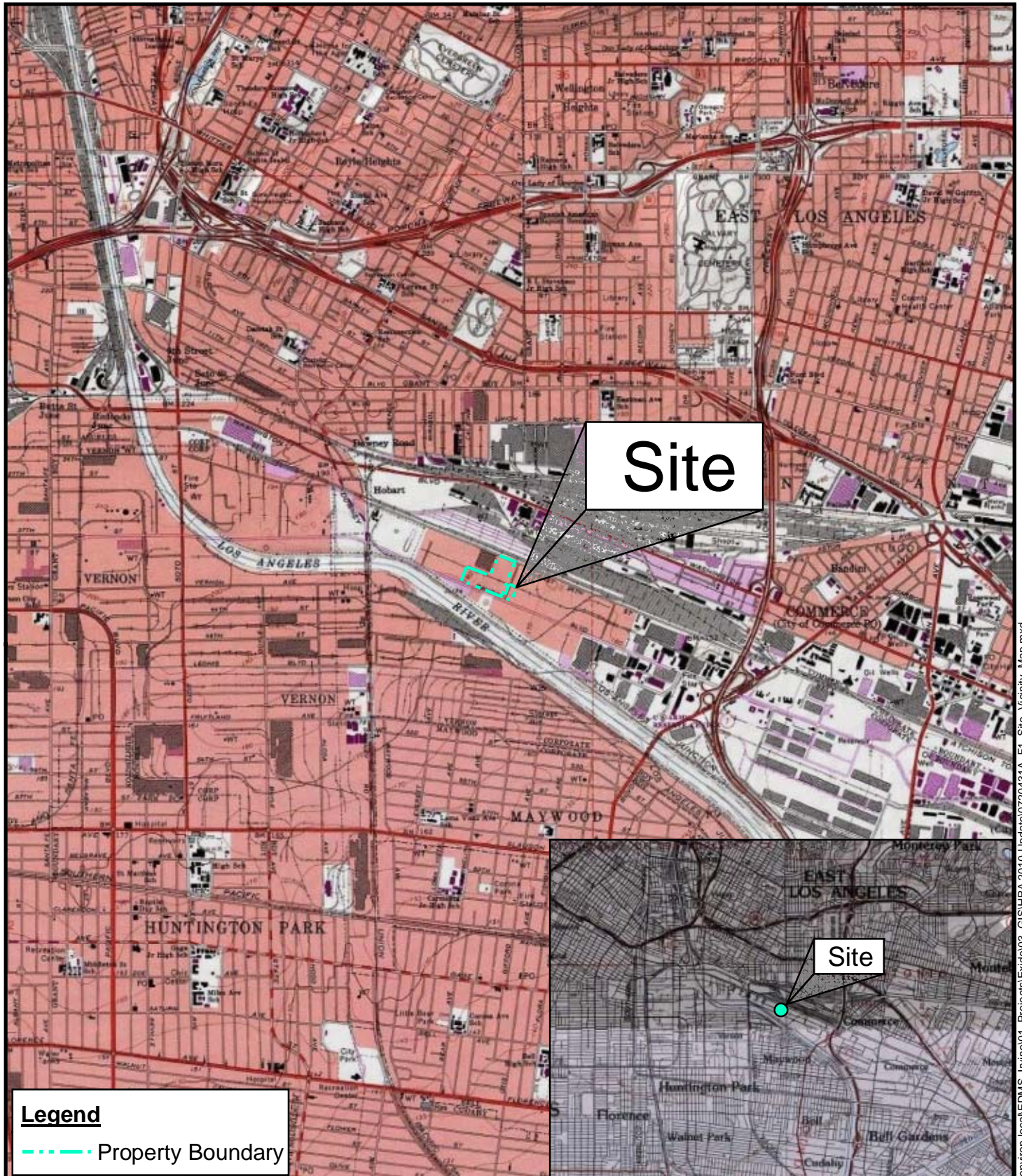

Legend
 - - - - - Property Boundary

SOURCE:
 U.S.G.S. 7.5 minute series (topographic)
 Los Angeles, CA Quadrangle
 National Geographic TOPO!
 Seamless, scanned images of
 USGS paper topographic maps
 © 2010 National Geographic Society

Map Created with ESRI ArcMap and National Geographic TOPO!™ ©2001 National Geographic Holdings (www.topo.com)



CONTOUR INTERVAL 40 FEET
 NATIONAL GEODETIC VERTICAL DATUM OF 1929
 1:39,382.23



FILE: \\irvine06.irvine.environ.local\EDMS_Irvine01_Projects\Exide\03_GISHRA 2010 Update\0720431A_F1_Site_Vicinity_Map.mxd

ENVIRON

DRAFTED BY: MMcMeehan DATE: 9/10/2010

Site Vicinity Map

Exide Technologies Facility
 2700 South Indiana Street, Vernon, California

Figure 1

PROJECT: 07-20431A



\\IRVINE06.IRVINE.ENVIRON.LOCAL\EDMS_IRVINE\01_PROJECTS\EXIDE\04_CAD\FIGURES\07-20431AF02 SITE PLOT PLAN.DWG

ENVIRON

Site Plot Plan

Exide Technologies Facility
2700 South Indiana Street, Vernon, California

Figure
2

DRAFTED BY: SSSHIN

DATE: 9/10/2010

PROJECT: 07-20431A

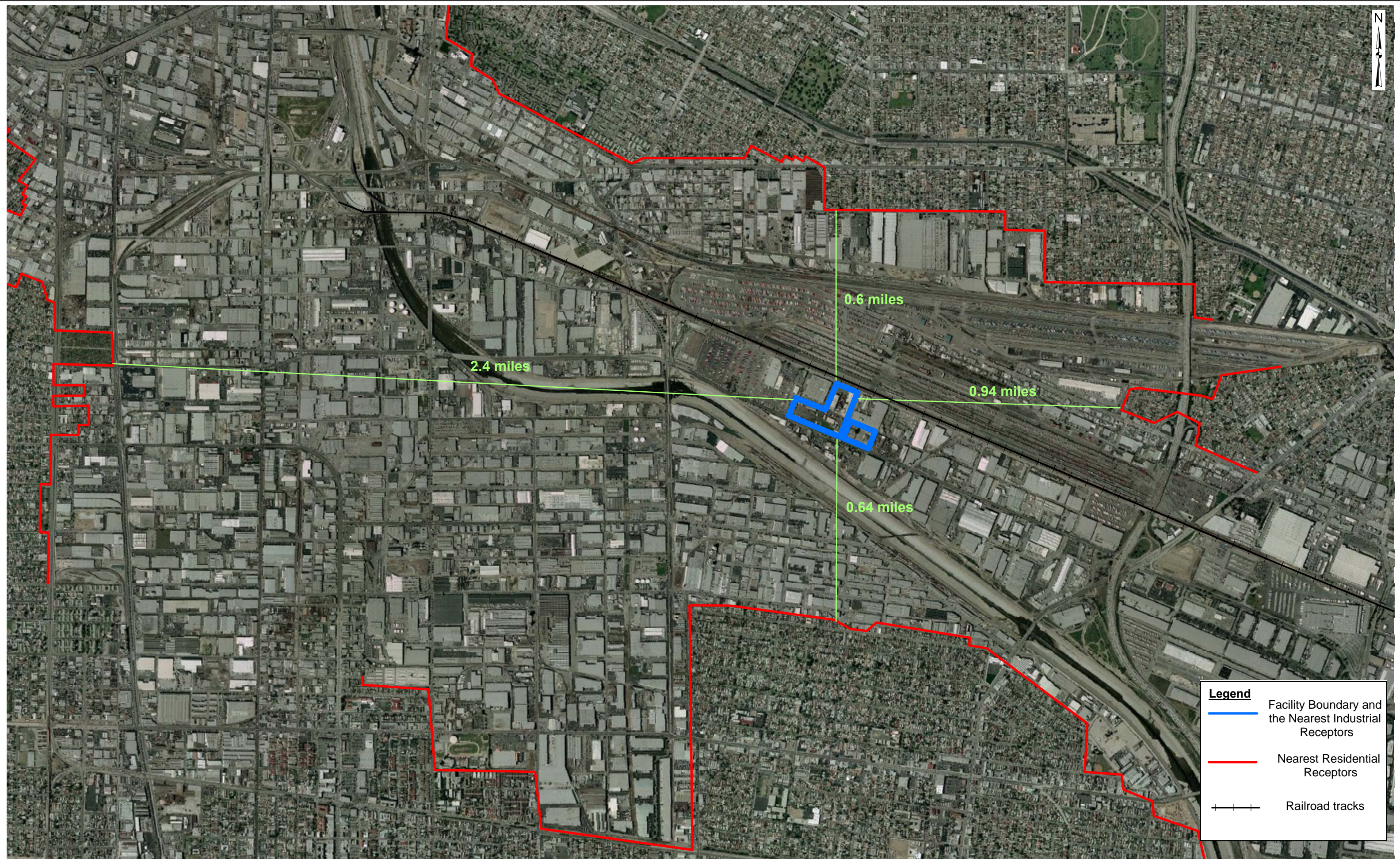

Legend

- Facility Boundary and the Nearest Industrial Receptors
- Nearest Residential Receptors
- +—+— Railroad tracks

Locations of the Nearest Residential Receptors

Exide Technologies Facility
 2700 South Indiana Street, Vernon, California

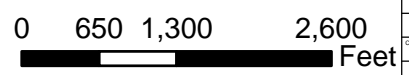

DESIGNED BY	AV
CHECKED BY	xxxx/xxxx
CONTOUR DATE	06/06/2008
CONTRACT NUMBER	07-20431A



FIGURE 4

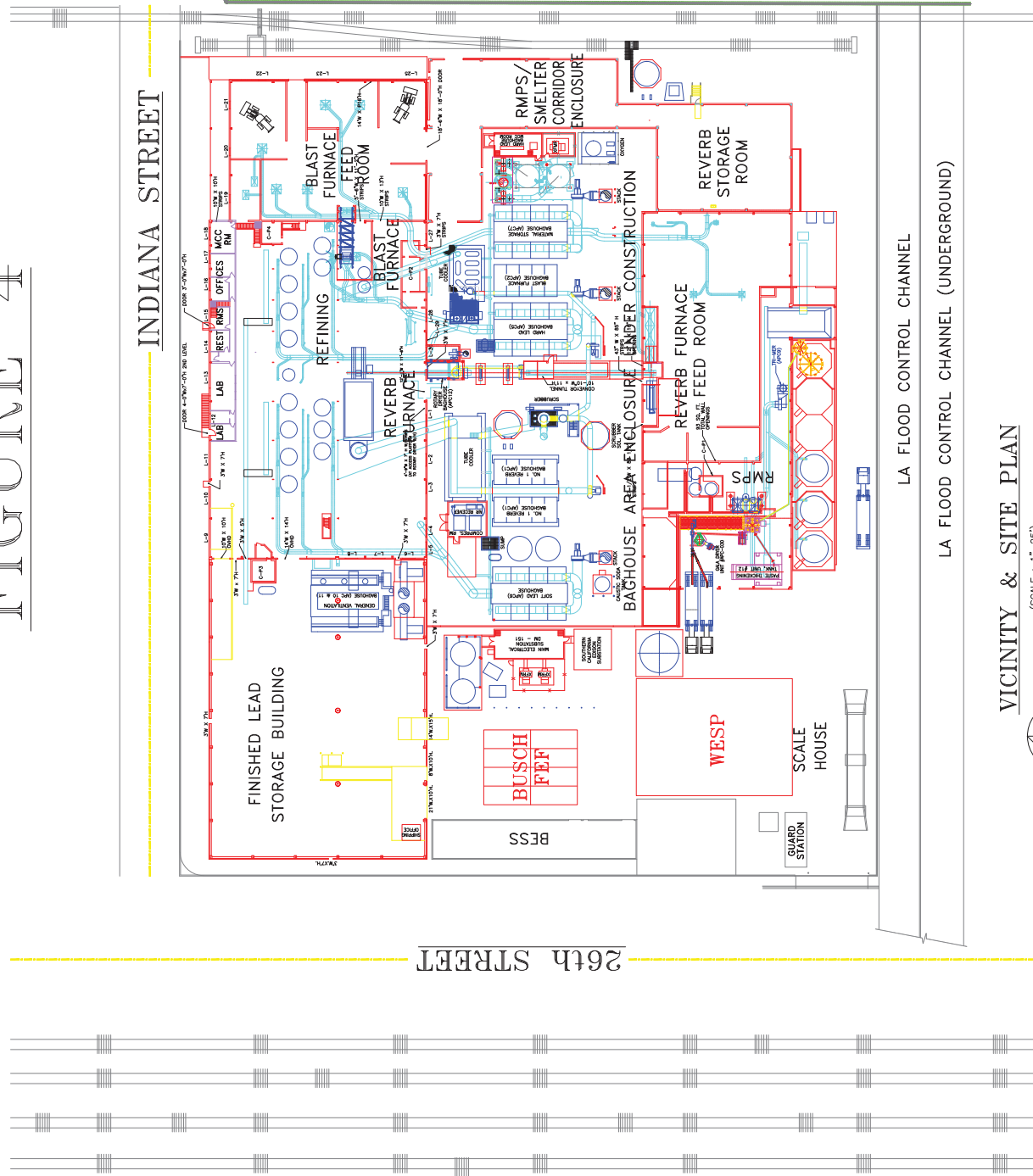

VICINITY & SITE PLAN

(SCALE : 1"=25')
 SITE SIZE: 15 ACRES
 TOTAL BUILDING AREA: 220,000 S.F.



EXIDE Technologies
 Automotive Recycling
 2700 S. Indiana St., Vernon, CA 90058

EXIDE TECHNOLOGIES, Inc. AUTOMOTIVE BATTERY RECYCLING ALABAMA, GEORGIA	
VERNON SITE PLAN	
PROJECT NUMBER	299135
PAC. NO. / SHEET / AREA	0000
SEQUENCE NUMBER	0

Appendix A
Envitech WESP Proposal for Exide Facility
Located in Los Angeles, CA



June 22nd, 2011

Mr. Russel Kemp – Environ Corporation on behalf of
Exide Technologies
2700 South Indiana Street
Vernon, CA 90058

Dear Mr. Kemp:

Envitech is pleased to offer Exide Technologies this budgetary proposal for a wet electrostatic precipitator (WESP) system to control lead emissions from various “process” sources and hooding located at the Vernon facility. This budgetary proposal is based on inlet conditions provided in the attachment to your May 11th, 2011 email. Our evaluation assumes the kiln dryer will be fitted with a HEPA filter capable of reducing the lead on that source by 95% from 0.0105 lb/hr to 0.000525 lb/hr.

Envitech recommends a wet electrostatic precipitator (WESP) system to reduce lead emissions from the process sources and hooding to 0.001 lb per hour. The system would be comprised of two (2) trains of five (5) WESP’s each. Each train would handle approximately 50% of the combined gas flow from these sources and would have one stack and two induced draft (ID) fans, 1 operating, and 1 spare. A packed bed absorber will be housed in the inlet section of the WESP units to distribute the gas evenly to the collection section and to neutralize any residual SO₂. This will help protect the stainless steel materials of construction.

The information contained in this proposal addresses the questions in your May 11th email. A summary of our responses to these questions are as follows:

- The expected level of emissions of lead from these sources, if controlled by a WESP, on a mass and exit concentration basis.

Envitech Response: The expected lead emissions are as follows:

- Mass Basis: 0.0005 to 0.0009 lb/hr
- Concentration Basis: 2.702E-7 to 4.864E-7 gr/dscf

- The level of emissions of lead from these sources that Envitech would be willing to guarantee if a WESP were employed.
 - We would seek and need that both the expectation and guarantee for lead emissions from this system be less than 0.001 lb/hr Pb on a mass basis as a maximum, but would like to know if even lower values are possible and at what incremental effort.

PREPARED FOR



2700 South Indiana Street
Vernon, CA 90058

PREPARED ON
June 22nd, 2011



Envitech Response: The performance guarantee is stated in Section 6.0, Performance Guarantee and Warranty. Envitech will guarantee 0.001 lb/hr Pb on a mass basis as a maximum. Lower values are possible, but the size and cost of the system are correlated to the design removal efficiency. We would need to know the target removal to assess the cost.

- We seek cost data on both a bare equipment and turnkey installed basis for any system or solution offered in response to the above.

Envitech Response: The budget estimate for equipment is provided in section 2.0, Budgetary Pricing. The equipment budget is between \$18M to \$22M. The estimated installed cost is \$25M to \$30M

- We seek data in regards to water consumption, wastewater generation rates, and utility consumption for any system or solution offered.

Envitech Response: The water and utility consumption are provided in a table in section 5.5, Operating Parameters and Utilities.

- We seek to know the physical ground footprint of any recommended system.

Envitech Response: The foot print will be approximately 7,500 square feet including the outlet duct and stack. A preliminary general arrangement drawing (29006GA, Rev. 0, attached) is provided for reference and is based on the Quemetco layout of 5 units in a row. An alternate configuration may also be considered depending on the available space. The final footprint area will depend on the final design and arrangement.

PREPARED FOR



2700 South Indiana Street
Vernon, CA 90058

PREPARED ON
June 22nd, 2011



Thank you for your interest and confidence in Envitech. If you need any additional information, please call me or visit our website at www.envitechinc.com. I look forward to hearing from you.

Sincerely,

Andrew C. Bartocci
National Sales Manger

PREPARED FOR



2700 South Indiana Street
Vernon, CA 90058

PREPARED ON
June 22nd, 2011



Table of Contents

- 1.0 Scope of Supply6
 - 1.1 Equipment.....6
 - 1.2 Optional Equipment6
 - 1.3 Equipment and Services Provided by Others.....6
- 2.0 Budgetary Price7
 - 2.1 Equipment.....7
 - 2.2 Optional Equipment7
 - 2.3 Equipment Startup and Training.....7
- 3.0 Exceptions and Clarifications7
- 4.0 Shipping and Payment Terms8
 - 4.1 Delivery Time.....8
 - 4.2 Shipping.....8
 - 4.3 Payment Schedule.....8
 - 4.4 Validity8
- 5.0 System Design9
 - 5.1 Design Basis.....9
 - 5.2 Design Considerations10
 - 5.3 Principles of Operation11
 - 5.3.1 Wet Electrostatic Precipitator11
 - 5.4 System Component Specifications.....13
 - 5.4.4 Wet Electrostatic Precipitators13
 - 5.4.6 Induced Draft (ID) Fans.....14
 - 5.4.6 Instrumentation and Controls15
 - 5.4.7 Pumps.....15
 - 5.4.8 Ducting & Stack.....15
 - 5.5 Operating Parameters and Utilities.....16
- 6.0 Performance Guarantee and Warranty16
 - 6.1 Performance Guarantee16
 - 6.2 System Warranty16
 - 6.3 Performance Warranty17
- 7.0 Operation and Maintenance Manual19

PREPARED FOR



2700 South Indiana Street
Vernon, CA 90058

PREPARED ON
June 22nd, 2011



8.0 Training and Start-up.....	19
9.0 Revision History	19
Appendix A: Drawings	20
Appendix C: Brochures	21

PREPARED FOR



2700 South Indiana Street
Vernon, CA 90058

PREPARED ON
June 22nd, 2011



1.0 Scope of Supply

1.1 Equipment

One (1) Envitech Syngas Cleaning System, including:

- Ten (10) wet electrostatic precipitators
- Two (2) Induced Draft Fans
- One (1) lot of instrumentation & control system
- One (1) lot of pumps
- One (1) lot of ducting & stack
- Operation and Maintenance Manuals

1.2 Optional Equipment

- Additional operation and maintenance Manuals.

1.3 Equipment and Services Provided by Others

- Installation of equipment.
- Inlet ductwork to the system.
- Piping, valves & fittings.
- All permits and special clearances required by Local State, or Federal agencies.
- Testing required by an independent third party required to establish performance.

PREPARED FOR



2700 South Indiana Street
Vernon, CA 90058

PREPARED ON
June 22nd, 2011



2.0 Budgetary Price

2.1 Equipment

One (1) Envitech WESP System US \$18,000,000
to \$22,000,000

The price does not include any sales, use, excise, or similar taxes.

- The estimated Installation Cost is \$7,000,000 to \$9,000,000.
- The estimated total installed cost is \$25,000,000 to \$30,000,000.

2.2 Optional Equipment

Option 1: Additional Operation and Maintenance Manuals US \$350

The price does not include any sales, use, excise, or similar taxes.

2.3 Equipment Startup and Training

Equipment start-up and operator training US \$75,000

The following support is included for the price shown above.

	<u>Days</u>
Startup, fine tuning	28
Operator Training	2

Additional days are charged at \$1,500 per day plus travel, food, and lodging at cost plus 15%.

3.0 Exceptions and Clarifications

PREPARED FOR

There are no exceptions or clarifications.



2700 South Indiana Street
Vernon, CA 90058

PREPARED ON
June 22nd, 2011



4.0 Shipping and Payment Terms

4.1 Delivery Time

Design drawings for approval: 10 to 16 weeks from receipt of order with down payment

Delivery to carrier: 20 to 24 weeks from receipt of design approval and release for fabrication

4.2 Shipping

Price is F. O. B. Point of Manufacture, including equipment only.

Freight will be added and billed at cost.

4.3 Payment Schedule

Payment will be per a payment schedule to be negotiated at the time of contract.

4.4 Validity

This quotation is budgetary only.

PREPARED FOR



2700 South Indiana Street
Vernon, CA 90058

PREPARED ON
June 22nd, 2011



5.0 System Design

5.1 Design Basis

The proposed system is designed to operate at the following parameters:

Inlet Gas Condition

	Kiln	Blast & Reverb	Hard Lead	Soft Lead	Combined
Gas Flow Rate, dscfm	10,392	19,035	95,037	91,415	215,879
Gas Flow Rate, scfm	11,877	22,989	97,175	93,471	225,512
Gas Flow Rate, acfm	15,245	26,190	102,572	100,130	243,868
Gas Temp, F	216	140	95	104	110
Upstream Press., in.W.C.	-1	-1	-1	-1	-1
Gas Composition, lb/hr					
H ₂ O	4,165	11,093	5,998	5,769	27,025
CO ₂	0	0	0	0	0
O ₂	10,875	19,919	99,452	95,662	224,909
CO	0	0	0	0	0
N ₂	35,815	65,602	327,553	315,050	743,999
SO ₂	0	0	0	0	0
Total	50,854	96,614	432,983	416,481	996,933
Particulate	0.000525*	0.000175	0.00663	0.00665	0.014

*Assumes the kiln is fitted with a HEPA filter capable of reducing lead emissions 95% from 0.0105 lb/hr to 0.000525 lb/hr.

PREPARED FOR



2700 South Indiana Street
 Vernon, CA 90058

PREPARED ON
 June 22nd, 2011



5.2 Design Considerations

None noted.

PREPARED FOR



2700 South Indiana Street
Vernon, CA 90058

PREPARED ON
June 22nd, 2011



5.3 Principles of Operation

The Envitech WESP System was developed by Envitech through years of research and is highly efficient in controlling metal emissions from industrial sources. The precipitators will be arranged in two (2) trains of five (5) units each. The exhaust gas first enters an inlet header of each train which distributes the gas to each of the WESP units. The WESP operation is further described below.

5.3.1 Wet Electrostatic Precipitator

5.3.1.1 Inlet Conditioning Section

The conditioning section houses the inlet and packed bed section for distributing the air flow equally to all cells of the collector section. The packed bed section is also wetted with recirculation liquid to ensure that the gas is saturated prior to entering the collector section. Acid neutralization with caustic can be used to protect the materials of construction of the collector section.

5.3.1.2 WESP Collector Section

In this section, electrostatic forces remove particles contained in the gas stream. The collector section is an array of grounded collector tubes and discharge electrodes. Voltage in the range of 30 to 40 kV is applied to the discharge electrodes both to charge the particles and to provide a high voltage field. The voltage emanating from disks on the discharge electrodes creates a corona discharge of electrons. Electrons move from the discharge disks to the collector tube. Some of the electrons intercept and charge particles in the gas stream. Once the particles are charged, they are moved across the gas stream by the high voltage field where they deposit on the grounded collector tube. The particles are then intermittently flushed from the collector tube with a stream of water.

PREPARED FOR 5.3.1.3 WESP Outlet and Electrode Housing



2700 South Indiana Street
Vernon, CA 90058

The outlet section contains an entrainment separator. The entrainment separator collects any water drops that were entrained in the gas stream during washing. The outlet section also houses the support structure for the discharge electrodes.

PREPARED ON
June 22nd, 2011



5.3.1.4 WESP High Voltage Transformer/Rectifier (T/R) with Controller

The power supply package supplies high voltage, full-wave, direct current (DC) power to the WESP. This allows automatic, unattended operation and provides all functions necessary to insure personnel safety and protect the equipment from upsets.

5.1.4.5 WESP Safety Interlock

The WESP is equipped with safety lock key interlocks that are interlocked with the main power to the T/R. This ensures that the high voltage areas in the power supply, the control cabinet, and the WESP cannot be entered without first de-energizing and grounding the bushing at the T/R.

After exiting the top of the WESP, the exhaust gas passes through an outlet header, Induced Draft (ID) fan and stack. There are two (2) ID fans, 1 operating and 1 spare.

PREPARED FOR



2700 South Indiana Street
Vernon, CA 90058

PREPARED ON
June 22nd, 2011



5.4 System Component Specifications

5.4.4 Wet Electrostatic Precipitators

Ten (10) high-efficiency Envitech wet electrostatic precipitators (WESP's).

Component	Description
Type	Upflow
Vessel Shells	316SS
Vessel Geometry	Square
Vessel Cross Section, ft	12 ft. x 12 ft.
Vessel Height, ft	30
Number of units	10 total (2 trains of 5 units each)
Footprint Area, Sq.ft (est.)	7,500
Inlet Conditioning Section	
Flow Distributor	316SS
Collector Section	316SS
Tube Type	Hexagon
Tube Length, in.	72
Tube Side Dimension, in	3
Tube Thickness, in	0.065
Discharge Electrodes	316SS
Type	Rigid Mast
Number of Emitter Disks per Electrode	6
Number of Discharge Crowns per Emitter Disk	25
Discharge Electrode Diameter, in.	1
Discharge Electrode Wall Thickness, in.	0.065
Power Grid Support	316SS
Insulator Support Assembly	
Quantity	4
Shell	CS
High Voltage Insulator	Porcelain
Outlet Section and Power Grid Housing	316SS
Entrainment Separator	316SS
Internal Wash Pipe	316SS
Wash Nozzle(s)	316SS
Access Doors	
Power Grid Housing	2 @ 24 in. \emptyset
Inlet Section	2 @ 24 in. \emptyset
Transformer/Rectifier	
Primary Voltage, V single phase	480
Secondary Voltage, kV	25 to 40

PREPARED FOR



2700 South Indiana Street
 Vernon, CA 90058

PREPARED ON
 June 22nd, 2011

This document contains confidential and proprietary information belonging exclusively to Envitech, Inc. Any reproduction in part or in whole without the written permission of Envitech Inc. is prohibited.



Component	Description
Secondary Current, mA	1,850
Insulating Fluid	Mineral oil
Voltage Divider Rating, mega ohm	80
Current Limiting Reactor	
Location	LV junction box
Reactance	30%, 40%, 50%
Ambient Temperature, C	40
Temperature Rise, C	55
Type	Full wave rectified DC; mineral oil filled
Rectifier	Silicon diode bridge
Housing	NEMA 3R
Primary Power Rating	480V @ 17 amps
Secondary Power Rating	40 kV @ 242 mA
Transformer Rectifier Controller	SQ-300i
Power Transmission Type	Pipe in guard
Purge Air System	
Heater	
Type	Electric resistance
Quantity	4
Power, kW each	2
Purge Gas Ducting	316SS
Filters	4
Safety Interlock System	All access points, T/R Set and controller

5.4.6 Induced Draft (ID) Fans

PREPARED FOR

The system includes a total of Two (2) ID fans 1 operating and 1 spare.



2700 South Indiana Street
 Vernon, CA 90058

PREPARED ON
 June 22nd, 2011

Instrument or Control	Number
Two (2) ID Fans	316SS
Two (2) VFD's	Included
Two (2) ID Fan Inlet Dampers	316SS
Two (2) ID Fan Outlet Dampers	316SS
Fan Motor HP, EA	
Connected	350
Operating	280



5.4.6 Instrumentation and Controls

The WESP system is designed for semi-automatic operation and includes instrumentation and a control system. Motor starters and control room building are by others.

Instrument or Control	Number
Level Transmitter	10
Level Switches	10
pH probe & Transmitter	10
Differential Pressure Transmitter(s)	2
Thermocouples	10
Liquid Flow Transmitter(s)	20
Pressure Gauge(s)	20
Control System	Included
Motor Starters and Control Room	By Others

5.4.7 Pumps

One (1) lot of recirculation pumps. Piping, valves, and fittings are by others.

Component	Description
Ten (10) Recirculation Pumps	20 HP/316SS
Piping, Valves & Fittings	By Others

5.4.8 Ducting & Stack

One (1) lot of interconnecting ducting fabricated as shown below.

Component	Description
Inlet Duct to System Inlet	By Others
Two (2) Inlet Headers	316SS
Two (2) Outlet Headers	316SS
Ten (10) WESP Inlet Dampers	316SS
Ten (10) WESP Outlet Dampers	316SS
One (1) Stack	316SS/70 ft Ht.

PREPARED FOR



2700 South Indiana Street
 Vernon, CA 90058

PREPARED ON
 June 22nd, 2011



5.5 Operating Parameters and Utilities

Following are the estimated operating parameters for both trains combined :

Operating Parameter/Utility	
System Inlet Pressure, in. WC	-1
Maximum Pressure Drop, in. WC	2
Fresh Water, gpm	2
Blowdown, gpm (estimated) ¹	2
Wash Water Flush, gpm ²	1,440
Electricity, kW	
T/R Set	246
Purge Air System	80
Motor Operating HP	
Recirculation Pumps	200
ID Fans	280
Caustic Consumption, gph ¹	TBD

¹Depends on the inlet SO₂ load which is unknown at this time.

²Operates for 1 min every 1 to 4 hours. The wash water will be rotated between the WESP units at 144 gpm at a time for 1 min every 1 to 4 hours per WESP unit.

6.0 Performance Guarantee and Warranty

6.1 Performance Guarantee

The proposed scrubbing system is designed to meet the following emission criteria:

PREPARED FOR

Lead (Pb) Outlet	0.001 lb/hr
------------------	-------------



2700 South Indiana Street
 Vernon, CA 90058

PREPARED ON
 June 22nd, 2011

6.2 System Warranty

The system is warranted for materials and workmanship one year from date of startup or 18 months after delivery, whichever comes first. The system warranty is based on operation of the system in compliance with Envitech's operating instructions, including proper preventative maintenance and the design basis described in section 5.1.

The following are specific exclusions to the warranty:

None noted

This document contains confidential and proprietary information belonging exclusively to Envitech, Inc. Any reproduction in part or in whole without the written permission of Envitech Inc. is prohibited.



In all situations involving non-conforming or defective products furnished under this warranty, Buyer's exclusive remedy is the repair or replacement of the products. Seller shall in its sole discretion have the option to elect repair or replacement of the products.

Seller shall not be liable for any indirect, special, incidental or consequential loss or damage (including, without limitation, loss of profits or loss of use) suffered by Buyer arising from or relating to Seller performance, non-performance, breach of or default under a covenant, warranty, representation, term or condition hereof.

6.3 Performance Warranty

Subject to the limitations of the General Terms and Conditions and the conditions stated herein, Envitech warrants the performance of the equipment at the performance levels specified above during a performance test to be conducted, or the warranty deemed satisfied, within ninety (90) days after start of initial operation or six (6) months after shipment, whichever occurs first, provided that the equipment, if in operation, has been installed and adjusted in accordance with Envitech engineering drawings and other written instructions. This warranty is conditional upon the Inlet Gas Conditions as specified in *Design Basis*.

Buyer shall give Envitech at least 30 days prior written notice of the date when the equipment will be ready for performance testing. If the equipment is not tested for performance within the time period specified in the above paragraph, through no fault of Envitech, or if Inlet Gas Conditions different than those specified above are encountered during performance testing, then the Envitech performance test obligation and this performance warranty will be deemed satisfied.

The System and Envitech shall be deemed to have satisfied obligations and this performance warranty when the average of three consecutive tests results in concentrations consistent with the applicable performance levels.

Prior to performance testing, Envitech may inspect the equipment at any reasonable time. If the equipment has been damaged after the transfer and passage of the risk of loss and damage from Envitech to the Buyer or mis-installed by Buyer, then Buyer shall at its expense, restore the equipment to operating condition satisfactory to Envitech prior to beginning of performance testing. If the equipment cannot be restored, Envitech will be released from its obligation.

Performance testing will be conducted by an independent testing laboratory, mutually acceptable to Buyer and Envitech. The initial battery of tests will be

This document contains confidential and proprietary information belonging exclusively to Envitech, Inc. Any reproduction in part or in whole without the written permission of Envitech Inc. is prohibited.

PREPARED FOR



2700 South Indiana Street
Vernon, CA 90058

PREPARED ON
June 22nd, 2011



conducted at Buyer's expense (including all fees and charges of the independent testing laboratory, as well as payment for the services, if requested, of an Envitech engineer at Envitech's then current daily service rate plus travel and living expenses). If the equipment performs at the applicable performance levels, as measured by the initial battery of tests, then the Envitech obligations and this performance warranty shall be deemed satisfied.

If the equipment fails to meet the applicable performance levels for reasons which are the fault or responsibility of Envitech, Buyer shall notify Envitech of the nonconformity in writing within 10 days of the knowledge of the nonconformity. Envitech, at its option, may make modifications, additions, or replacements to the equipment as it deems necessary to have the equipment function in accordance with said warranty. Envitech, at its expense, may request the independent laboratory to conduct additional tests to determine if the equipment is meeting the applicable performance levels. However, if the failure of the equipment to perform at the applicable performance levels occurs in whole or in part by reason of the fault or responsibility of third parties or of the Buyer, or its employees, agents or contractors, Buyer shall bear the expense of such additional tests.

Envitech and its engineers are to have access to all records, reports, results and other information relative to the equipment, as well as to all tests conducted by the independent testing laboratory. Immediately after completion of the tests, the Buyer shall cause the independent testing laboratory to transmit an unedited copy of the test reports and results to Envitech. At any time that this performance warranty is satisfied, or deemed satisfied, or Envitech is relieved of performance warranty obligations, any portion of the contract price not yet paid will immediately become due and payable to Envitech.

PREPARED FOR



2700 South Indiana Street
Vernon, CA 90058

PREPARED ON
June 22nd, 2011



7.0 Operation and Maintenance Manual

One printed copy of the operating and maintenance manual is provided. The manual contains all the information needed to operate, maintain, and troubleshoot the incinerator gas cleaning system.

The manual also includes general arrangement drawings, process flow diagrams, P & ID diagrams, wiring diagrams (with pre-wired option), sequence of operations, manufacturers' catalog sheets for purchased components, recommended sources of replacement parts, and spare parts list.

8.0 Training and Start-up

Start-up and installation supervision is provided as outlined in the proposal. Additional training and assistance is available on a per diem basis plus travel costs.

The training covers system design, start-up and shut-down procedures, basic control functions, and trouble shooting. The training schedule can be adjusted to meet the specific needs of various groups of personnel and different plant conditions

9.0 Revision History

Revision	Date	Author	Prepared For	Description
00	06/22/11	ACB	R. Kemp	Preliminary Budget Proposal

PREPARED FOR



2700 South Indiana Street
Vernon, CA 90058

PREPARED ON
June 22nd, 2011



Appendix A: Drawings

The following drawings are for reference only. Equipment, materials of construction and quantities are defined in 5.4 System Component Specifications.

- 29006GA, Rev 0 for Reference Only

PREPARED FOR



2700 South Indiana Street
Vernon, CA 90058

PREPARED ON
June 22nd, 2011

REVISIONS			
REV.	DESCRIPTION	DATE	APPROVED
A	INITIAL RELEASE	6/16/2011	R. PATTERSON

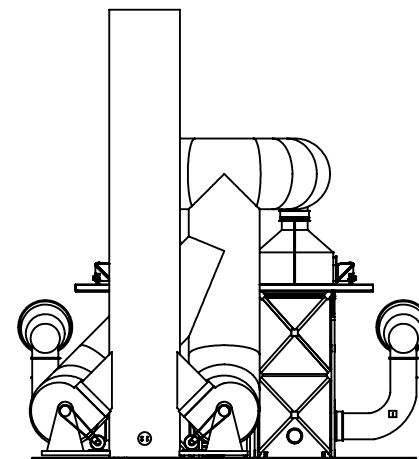
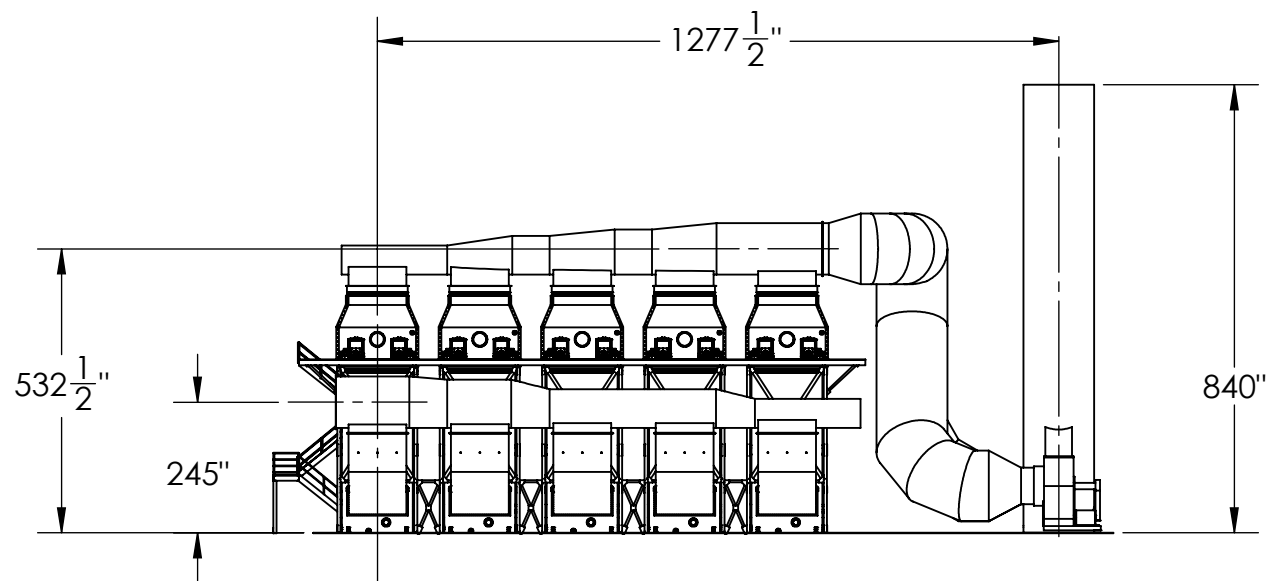
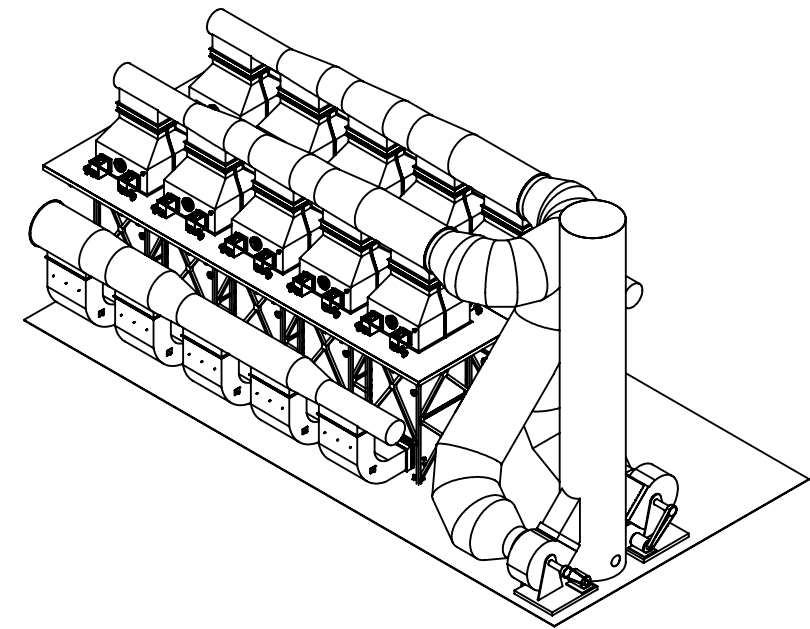
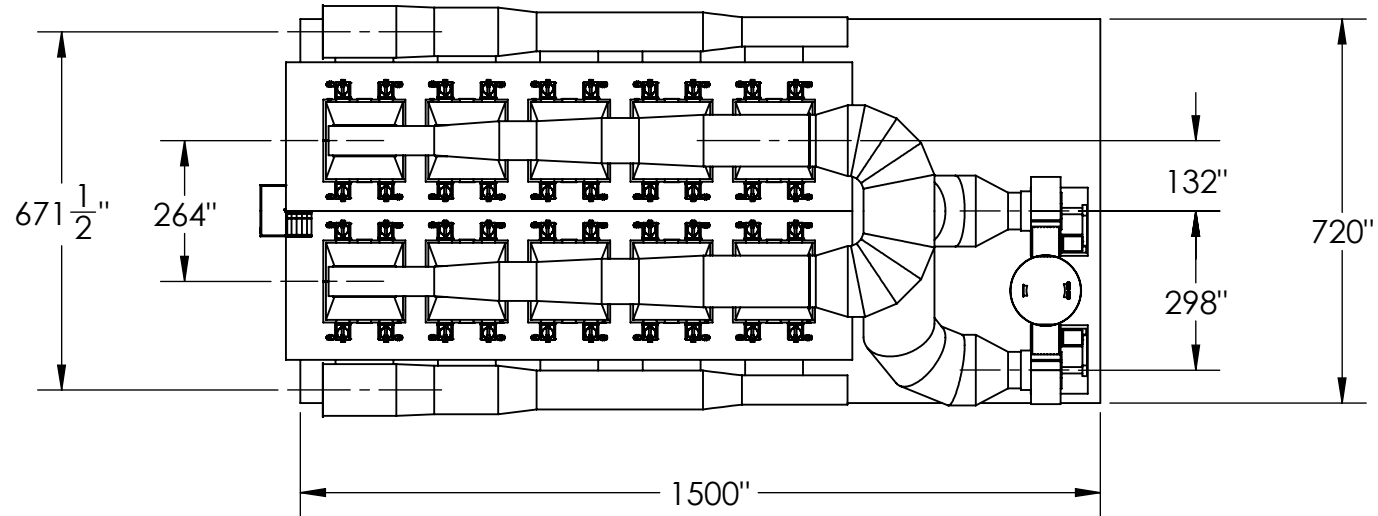

UNLESS OTHERWISE SPECIFIED:		NAME	DATE	 Envitech 2924 Emerson Street San Diego, CA 92106 (619) 223-9925 (619) 223-9938 FAX	
DIMENSIONS ARE IN INCHES		DRAWN	AJO		6/16/11
TOLERANCES:		CHECKED			
FRACTIONAL ±		PROJ ENG	AJO		6/16/11
ANGULAR: MACH ± BEND ±		MATERIAL			
TWO PLACE DECIMAL ±		FINISH			
THREE PLACE DECIMAL ±		PROJECT:	EXIDE		
INTERPRET GEOMETRIC TOLERANCING PER:					
PROPRIETARY AND CONFIDENTIAL					
THE INFORMATION CONTAINED IN THIS DRAWING IS THE SOLE PROPERTY OF ENVITECH INC. ANY REPRODUCTION IN PART OR AS A WHOLE WITHOUT THE WRITTEN PERMISSION OF ENVITECH INC. IS PROHIBITED.					
		TITLE:		GENERAL ARRANGEMENT	
SIZE	DWG. NO.	REV			
B	29006GA	A			
SCALE: 1:36		WEIGHT:	SHEET 1 OF 1		



Appendix C: Brochures

- Industrial Gas Cleaning System Brochure
- Enviech WESP Cut Sheet

PREPARED FOR



2700 South Indiana Street
Vernon, CA 90058

PREPARED ON
June 22nd, 2011



Appendix C: Terms and Conditions

PREPARED FOR



2700 South Indiana Street
Vernon, CA 90058

PREPARED ON
June 22nd, 2011

ENVITECH

General Terms and Conditions

Acceptance

Unless otherwise provided, this Proposal is subject to acceptance by Buyer within sixty (60) days from the Proposal date. Acceptance of this Proposal is limited to the terms and conditions herein. Envitech rejects all additional or different terms proposed by Buyer, except with Envitech's prior written consent. Buyer will reimburse Envitech for all reasonable costs and all other loss and damage resulting from the amendment or termination of this Proposal.

Terms of Payment

Except as otherwise provided in the Proposal, payment shall be by check or bank transfer according to the *Payment Schedule*. If Buyer fails to make any payments in accordance with the terms and provisions hereof, Envitech, in addition, but not in limitation, to its other rights and remedies, may at its option, either terminate the Contract or suspend further deliveries under it until payments have been brought current.

Shipping

Unless otherwise provided, all shipments shall be made F.O.B. shipping point. Title and risk of damage to or loss of goods shall pass to the Buyer upon delivery by Envitech to the carrier. If the shipment of any or all of the equipment is postponed or delayed by Buyer for any reason, including a Force Majeure situation, Buyer agrees to reimburse Envitech for any and all storage costs and other additional expenses resulting there from.

Force Majeure

Envitech shall not be liable for loss or damage for delay in delivery or failure to manufacture due to causes beyond its reasonable control including, but not limited to, acts of God, the government or the public enemy, riots, embargoes, strikes or other acts or workmen, casualties or accidents delays in deliveries and transposition and shortages of cars, fuel, power, labor, or material.

Material/Workmanship Warranty

Envitech will repair or replace, in its sole discretion, any equipment which has been manufactured to Envitech's special design and sold hereunder which is found to be defective in workmanship or materials, within twelve (12) months from its respective final acceptance date or eighteen (18) months from its respective shipment date, whichever comes first. Buyer's obligations hereunder are subject to the following conditions:

a) Buyer notifies Envitech in writing within fifteen (15) days after such defect becomes apparent and promptly furnishes Envitech full particulars in

connection therewith, together with an opportunity to witness the operation of such defective equipment.

b) Buyer shall have installed (if applicable), operated and maintained the equipment strictly in accordance with Envitech's operating and maintenance instructions, including, but not limited to, the use of only those materials specified in the Proposal and in the inlet quantities stated in the Proposal.

c) The defect has been caused solely by faulty materials or workmanship for which Envitech is responsible, and is not due to such things as erosion, corrosion, or deterioration resulting from the manner in which the equipment is operated, accident (including damage during shipment, neglect, misuse or abuse, or exposure to conditions beyond the environmental power or operating constraints specified by Envitech.

Envitech makes no warranty with respect to equipment and materials not furnished by Envitech pursuant to this Proposal or with respect to equipment furnished by Envitech pursuant to this Proposal which has not been manufactured to Envitech's special design, but will pass on or assign to Buyer to the extent legally permissible, the warranties, if any, obtained from manufacturers of such items of equipment.

Any repairs made under this warranty will be done on site, if feasible, or at the place of manufacture. Any round-trip freight transportation charges required for returning material deemed defective to the place of manufacture must be paid by Buyer. All costs associated with removing or reinstalling the defective equipment will be at Buyer's sole expense.

Limitation of Warranties

The warranties and guaranties furnished by Envitech, as expressly included herein, constitute Envitech's sole obligation hereunder and are in lieu of any other warranties or guaranties, express or implied, including warranties of merchantability or fitness for a particular purpose.

Taxes

Unless otherwise provided, Buyer agrees to pay any tax or import duty imposed by any federal, state, local or municipal Authority upon the equipment or related services described in this Proposal.

Installation

Unless otherwise provided, Envitech shall have no responsibility for, and Buyer hereby waives and relinquishes any claims related to, the installation, start-up and operation of the equipment to be furnished hereunder. If this agreement so provides, Envitech shall furnish advisory personnel to assist in installation and start-up of the equipment and to instruct Buyer's personnel in the operation of Envitech's equipment. Although Envitech will be responsible for mechanical adjustments to its equipment, Envitech has no responsibility for, and Buyer hereby waives and relinquishes any claims related to, correctness of site installation, the appropriateness and compatibility of the installation with respect to Buyer's facility or ability of Buyer's personnel to correctly operate and maintain Envitech's equipment.

Buyer agrees to defend, indemnify and hold harmless Envitech from and against any loss, costs (including reasonable attorneys' fees and costs), claims, suits or causes of action brought, threatened or incurred by or against Envitech arising from or in any way related to the installation, start-up and operation of the equipment to be furnished hereunder.

Inventions and Patents

Envitech grants no license by reason of any sale under any patent rights it may now own or hereafter acquire except the right to use the equipment sold hereby for the purpose for which it is sold under such patent rights, only as it covers said equipment as sold by Envitech. All drawings, novel techniques, special tooling and inventions made or acquired by Envitech or its agents or employees in the fulfillment of this proposal shall be the property of Envitech regardless of whether any order document states a separate price item for tooling or engineering. Buyer agrees to indemnify and hold Envitech harmless from and against any expense or loss from infringement of patents or trademarks arising from compliance with the Buyer's designs, specifications or instructions in the manufacture of the equipment or its use in combination with other equipment or systems.

Limitation of Remedies

Envitech's entire liability and Buyer's exclusive remedy are set forth in this Section:

In all situations involving non-conforming or defective Products furnished under this Agreement, Buyer's exclusive remedy is the repair or replacement of the Products. Envitech shall in its sole discretion have the option to elect repair or replacement of the Products.

Envitech's liability for actual damages for any cause whatsoever shall be limited to the applicable unit price for the specific components of the Product that caused the damages or that are the subject matter of, or are directly related to, the cause of action. This limitation will apply, except as otherwise stated in this Section, regardless of the form of action, whether in contract or in tort, including negligence.

Envitech shall not be liable for any indirect, special, incidental or consequential loss or damage (including,

without limitation, loss of profits or loss of use) suffered by Buyer arising from or relating to Envitech's performance, non-performance, breach of or default under a covenant, warranty, representation, term or condition hereof. Except as specifically provided in the preceding sentence, Buyer waives and relinquishes claims for indirect, special, incidental or consequential damages.

Buyer expressly waives any right to recover punitive damages from Envitech, and Buyer hereby waives and relinquishes any and all punitive damage claims.

The limitations on liability and damages set forth in this section apply to all causes of action that may be asserted here under, whether sounding in breach of contract, breach of warranty, tort, product liability, negligence or otherwise.

Security

Envitech reserves a security interest in the equipment sold hereunder and in all accessions to, replacements for and proceeds of such equipment, until the full contract price, plus all other charges permitted hereunder, including any charges, costs or fees contemplated in the *Attorney's Fees, Venue and Jurisdiction* section below, are paid in full by Buyer. If so requested by Envitech, Buyer shall execute all security agreements, financing statements, promissory notes and all other security documents requested by Envitech in the form determined by Envitech.

Dispute Resolution

The Parties agree that any controversy, dispute or claim arising from or in any way related to this Agreement or the materials or equipment provided by Envitech shall be resolved by binding arbitration. The parties agree that jurisdiction for any arbitration shall be with the San Diego, California office of the Judicial Arbitration and Mediation Service ("JAMS") and the Parties hereby expressly agree to be bound by the then-prevailing JAMS rules applicable to commercial arbitrations.

Any dispute subject to arbitration shall be submitted to a single neutral arbitrator, who, unless otherwise agreed by the Parties, shall be a retired judge or other lawyer who is a member of the arbitration panel of the San Diego office of JAMS and who has substantial experience in the area of the Dispute. JAMS shall submit to each Party an identical list of five proposed qualified arbitrators drawn from the applicable panel of commercial arbitrators. If the Parties are unable to agree upon an arbitrator within thirty (30) days from the date that JAMS submits such list to each Party, then JAMS shall simultaneously submit to each Party a second list of five additional proposed qualified arbitrators drawn from the applicable panel of commercial arbitrators. If for any reason, the appointment of an arbitrator cannot be made from either list, JAMS may make the appointment from among other qualified members of the panel without the submission of additional lists to the Parties.

The Parties shall be entitled to obtain pre-hearing discovery through depositions and requests for the inspection and copying of documents and other items upon reasonable notice and to obtain the issuance of a

subpoena duces tecum therefor in accordance with applicable law, provided that depositions shall not be taken unless leave to do so is first granted by the arbitrator. As between the Parties, the arbitrator shall have the power to enforce the rights, remedies, procedures, duties, liabilities and obligations of discovery by the imposition of the same terms, conditions, consequences, sanctions and penalties as may be imposed in like circumstances in a civil action by a California Superior Court.

Any award rendered by the arbitrator shall be reduced to a judgment and may be entered in any Court authorized to have jurisdiction under this Agreement.

The parties expressly waive any right they may have to a jury trial.

Venue and Jurisdiction

Each Party irrevocably consents to the jurisdiction of the state courts located in San Diego, California, and agrees, subject to the provisions contained in the paragraph entitled "Dispute Resolution" above, that any action, suit or proceeding by or among the Parties (or any of them) may be brought in any such court sitting in San Diego, California, and waives any objection which the Party may now or hereafter have concerning jurisdiction and venue, whether based on considerations of personal jurisdiction, forum non conveniens or on any other ground.

Attorney's Fees

In the event of any litigation, arbitration, judicial reference or other proceeding involving the Parties to this Agreement to enforce any provision of this Agreement, to enforce any remedy available upon default under this Agreement, or seeking a declaration of the rights of a Party under this Agreement, the prevailing Party(ies) shall be entitled to recover from the other(s) such attorneys' fees and costs as may be reasonably incurred, including the cost of reasonable investigation, preparation and professional or expert consultation incurred by reason of such litigation, arbitration, judicial reference or other proceeding.

Sound Levels

The combined sound or noise levels produced by individual sound generating devices, and the exposure of workmen to such, will depend on Buyer's plant noise levels over which Envitech has no control. Therefore, Envitech makes no guarantees, warranties or representations with respect to sound levels. If, after the equipment to be furnished hereunder is installed, it is determined that the system does not meet the maximum permissible sound levels or exposures, or that changes in OSHA requirements necessitate equipment modifications or additions, Envitech shall assist Buyer in designing and providing equipment and materials required, provided that an equitable adjustment of the contract price and proposed schedule is made.

Design Criteria

Envitech's Proposal is based upon design criteria supplied by Buyer and Envitech assumes no responsibility for the accuracy of such criteria. Buyer recognizes, and the parties hereto intend, that Envitech shall not be obligated to meet its performance guarantee hereunder if the actual design conditions are found to be different from those upon which Envitech's Proposal is based.

Additions or Changes in the Work

Buyer agrees to pay Envitech reasonable charges for additional work outside the scope of any contract resulting from Envitech's Proposal as requested by Buyer by changes indicated by Buyer on Envitech's drawings, by letter, or by change order or other written instruction, and an equitable adjustment of the contract price and proposed schedule will be made by the parties.

Termination or Cancellation

In the event that Buyer terminates or cancels all or any portion of its order, Buyer shall compensate Envitech for all costs and expenses already incurred including, but not limited to, the price of any goods or services required to fill said order already committed to by Envitech, a pro rata portion of the contract price representing work completed prior to such termination or cancellation and a reasonable allowance for overhead and profit.

Miscellaneous

This Proposal represents the entire understanding and agreement between the parties hereto with respect to the subject matter hereof and supersedes all prior negotiations, letters and understandings relating to the subject matter hereof and cannot be amended, supplemented or modified except in writing signed by the party against whom the enforcement of any such amendment, supplement or modification is sought.

Failure of Envitech at any time or times to require performance of any provision of this proposal shall in no manner affect its right to enforce the same, and a waiver by Envitech of any breach of any provision of this proposal shall not be construed to be a waiver by Envitech of any succeeding breach of such provision or a waiver by Envitech of any breach of any other provision.

The rights, privileges, duties and obligations covered herein, including the transactions and agreements covered and contemplated hereby, shall be binding upon and inure to the benefit of the parties hereto and their respective successors and assigns provided, however, Buyer may not assign any of its rights, privileges, duties or obligations hereunder without the prior written consent of Envitech, and any purported or attempted assignment without such written consent shall be null and void *ab initio*.

Appendix B
BUSCH FEF Statement



10431 Perry Highway, Wexford, PA 15090 Ph: 724-940-2326 Fax 724-940-4140

July 7, 2011

ENVIRON International Corporation
1600 Parkwood Circle, Suite 310
Atlanta, GA 30339

ATTN: Russell Kemp, Principal

Dear Russell:

Subject: Busch International Fugitive Emissions Filtration (FEF) Units

This revised letter summarizes several points from our recent conversations.

The Busch FEF Unit is a highly efficient and cost effective way to control fugitive lead dust emissions within lead processing facilities. These units offer the following features and benefits:

- Compact horizontal configuration for roof mounting, inline mounting or tight indoor locations.
- Self cleaning reverse jet pulse high efficiency filter system followed by a HEPA polishing filter stage.
- Easy to service walk-in configuration.
- Cost effective packaged design incorporates the fan, motor, controls and filtration system in one economical package.
- Proven performance on many lead industry and other metallurgical fume applications.

During our discussions, Environ presented outlet emission test data, which is reported to have come from other Busch FEF unit installations within the lead industry. These field tests from 1997-1998 show lead particulate outlet emission concentrations of less than 0.0001 Grains/DSCF. In some cases, outlet concentrations are as low as 0.0000003 Grains/DSCF. These levels are all below emission limits that could be "guaranteed".



Busch International believes that past performance is a good indication of expected future results. This will be true especially for like applications. Note however, that installations of this type are highly variable in nature and the prediction of filter system dust removal efficiency and/or outlet emission concentration is theoretical at these very low levels. The inlet dust loading and particle size distribution associated with each installation will likely vary. For these reasons, Busch expects to see similar outlet emission levels on similar applications in the future, but we cannot guarantee outlet emissions at these low levels

We look forward to the opportunity to work with you further. Please contact Lois McElwee or me if you have any questions.

Sincerely,

A handwritten signature in black ink, appearing to read 'William W. Frank'.

William W. Frank
President

C: Lois McElwee –Regional Manager

Appendix C
US EPA Draft Cost Impacts for the
Secondary Lead Smelting Source Category
and Data Table

MEMORANDUM

To: Chuck French, U.S. Environmental Protection Agency, OAQPS

From: Donna Lazzari and Mike Burr, ERG

Date: April 2011

Subject: Draft Cost Impacts for the Secondary Lead Smelting Source Category

The purpose of this memorandum is to describe the methodology used to estimate the costs, emissions reductions, and secondary impacts of the proposed revisions to the National Emissions Standards for Hazardous Air Pollutants (NESHAP) for the Secondary Lead Smelting source category. These impacts were calculated for existing units and new units projected to be operational by the year 2014, two years after the rule is expected to be promulgated and the anticipated year of implementation of the revised NESHAP. The results of the impacts analyses are presented for the most stringent regulatory options considered in addition to the regulatory options that were ultimately chosen for proposal. The development of the baseline emissions estimates and the maximum achievable control technology (MACT) floors for this source category are discussed in other memoranda^{1,2}. The organization of this document is as follows:

- 1.0 Summary of Cost Estimates and Emissions Reductions for the Regulatory Options Chosen for Proposal
- 2.0 Regulatory Options Considered for Proposal
- 3.0 Methodology for Estimating Control Costs
- 4.0 Methodology for Estimating Emissions Reductions
- 5.0 Testing and Monitoring Cost Impacts
- 6.0 Summary of Cost by Facility

1.0 SUMMARY OF COST ESTIMATES AND EMISSIONS REDUCTIONS FOR THE REGULATORY OPTIONS CHOSEN FOR PROPOSAL

Regulatory options were considered for control of emissions of metal hazardous air pollutants (HAP), organic HAP, and dioxins and furans (D/F) from stacks and metal HAP from fugitive sources. For all options, total hydrocarbons (THC) are considered a surrogate for organic HAP (other than dioxins and furans) and lead a surrogate for metal HAP. A brief

¹ ERG. Development of the RTR Emissions Dataset for the Secondary Lead Smelting Source Category, Mar. 2011.

² ERG. MACT Floor Analysis for the Secondary Lead Smelting Source Category, Mar. 2011.

description of the options selected for the proposed revisions to the NESHAP and the associated costs and emissions reductions are summarized in Table 1-1. The most stringent options considered in this analysis are summarized in Table 1-2. A more detailed description of all the regulatory options considered for proposal and their associated cost and emissions reductions estimates are presented in section 2.0 of this memorandum.

Table 1-1: Summary of the Estimated Costs and Emissions Reductions of Regulatory Options Selected for Proposal

Option	Description	COST IN \$ MILLIONS (2009 DOLLARS)				Total HAP Emissions Reductions (tons per year)	Cost per ton HAP reduction (\$MM)
		Capital Cost	Annualized Capital Cost	Annual Operation and Maintenance Cost	Total Annualized Cost		
3S	Stack lead concentration limit of 1.0 mg/dscm any stack, and 0.2 mg/dscm facility average	\$7.7	\$0.7	\$0.9	\$1.7	5.9	\$0.29
1D	D/F Concentration based limit	\$0	\$0	\$0.26	\$0.26	30*	\$0.009
3F	Fugitive enclosure + work practice	\$40	\$3.8	\$5.8	\$9.6	9.5	\$1.0
Test, Monitor, Report	Additional Testing, Monitoring	\$0.33	\$0.03	\$1.0	\$1.0		
Total		\$48.0	\$4.5	\$8.0	\$12.6	45.4	\$0.28

*Tons of total organic HAP (3 grams/yr D/F reduction)

Table 1-2: Summary of the Estimated Costs and Reductions for the Most Stringent Options

Option	Description	COST IN \$ MILLIONS (2009 DOLLARS)				Total HAP Emissions Reductions (tons per year)	Cost per ton HAP reduction (\$MM)
		Capital Cost	Annualized Capital Cost	Annual Operation and Maintenance Cost	Total Annualized Cost		
2S	0.009 lb/ton Pb emissions limit	\$23.9	\$2.3	\$2.7	\$5.0	9.6	\$0.52
2D	Beyond the floor D/F limits for	\$5.9	\$0.56	\$2.4	\$2.9	200*	\$0.015

Option	Description	COST IN \$ MILLIONS (2009 DOLLARS)				Total HAP Emissions Reductions (tons per year)	Cost per ton HAP reduction (\$MM)
		Capital Cost	Annualized Capital Cost	Annual Operation and Maintenance Cost	Total Annualized Cost		
	blast furnaces						
1F and 2F	Enclosures, work practices, monitoring	\$40	\$3.8	\$6.1	\$9.9	9.5	\$ 1.04
Test, monitor, report	Additional testing and monitoring	\$0.33	\$0.03	\$1.0	\$1.0		
Total		\$70.1	\$6.7	\$14.4	\$18.8	219	0.086

*We estimate a total of 200 tons of reductions in organic HAP emissions, including 31 grams of dioxins and furans, under this beyond-the-floor option.

2.0 REGULATORY OPTIONS CONSIDERED FOR PROPOSAL

This section provides a detailed description of all regulatory options that were considered for the proposed revisions to the Secondary Lead Smelting NESHAP and their associated costs and secondary impacts.

2.1 Stack Emissions – Metal HAP

The four regulatory options considered for control of metal HAP emissions from stacks are presented in the following sections.

a. *Option 1S*

Regulatory option 1S represents a scenario of reducing the existing lead emissions concentration limit from the 2.0 milligrams per dry standard cubic meter (mg/dscm) to 0.5 mg/dscm. Based on emissions data received in an information collection request (ICR) sent to the industry, 90 percent of the stacks in this source category reported concentrations below 0.5 mg/dscm. Ten emissions points at six facilities reported concentrations above 0.5 mg/dscm; estimates of cost and emissions reductions were made for 8 of these stacks. One facility is currently undergoing an upgrade with plans to replace existing baghouses, and thus, we assumed this would reduce the lead concentration at this stack below 0.5 mg/dscm. For seven of the stacks reporting concentrations above 0.5 mg/dscm, we assumed that a replacement baghouse would be installed. For one stack at which a baghouse was recently installed, we assumed that lead concentrations below 0.5 mg/dscm could be achieved through replacement bags performance of additional maintenance on the unit. One additional stack reported concentrations that were very close to 0.5 mg/dscm; no costs for were estimated for this unit. The total estimated capital cost for the seven new baghouses that would likely be necessary to achieve

concentrations below 0.5 mg/dscm is \$11.8 million, resulting in an annualized capital cost of \$1.1 million. Additional annual operational and maintenance costs, including more frequent bag changes for the baghouses, are estimated at \$1.6 million above the costs of operating the current air pollution control devices. The total estimated annualized cost above current cost for the 8 baghouses is \$2.7 million (2009 dollars). The estimated emissions reductions of Option 1S are 6.5 tons per year of lead and 8.3 tons per year of total metal HAP.

b. Option 2S

Option 2S considers a production-based lead emissions limit. A limit of 0.009 pounds of lead emissions per ton of lead production (lbs/ton Pb) was calculated as a facility-wide emissions limit using a methodology similar to a MACT floor analysis. We estimate that new or improved baghouses would likely be necessary at 19 emissions points at six facilities to meet the limit considered in this option. For facilities that were estimated to be above the limit considered in this option, we sequentially selected stacks for a baghouse replacement or upgrade (based on reported concentration) until the facility was estimated to have emissions below 0.009 lbs/ton Pb. Two of the stacks selected had relatively newer baghouses, and thus, we estimated the cost of changing all the existing bags to a new upgraded filter media and performing additional maintenance for these units. One selected stack had a baghouse that was less than 10 years old; we estimated 25 percent of the cost of a new unit to represent additional filtration media or substantial upgrade to this unit. For the remainder of the selected stacks, assumed replacement baghouses would be needed.

The total estimated capital cost for this regulatory option is \$23.9 million, resulting in an annualized capital cost of \$2.3 million. Additional annual operational and maintenance costs, including more frequent bag changes for the baghouses, are estimated at \$2.7 million above current costs. The total annualized cost above current air pollution control device operating costs for the 19 baghouses is \$5.0 million (2009 dollars). Total anticipated emissions reductions of lead and other metal HAP in this option are estimated at 9.6 tons per year.

c. Option 3S

Option 3S is the regulatory option that was selected by EPA for proposal in the Secondary Lead Smelting NESHAP. This option represents an overall facility-wide flow-weighted average lead concentration limit of 0.2 mg/dscm and a limit of 1.0 mg/dscm for any individual stack. We estimate that this option would require reductions in lead emissions at three emissions points located at two facilities. We assumed that replacement baghouses would be needed at each of these emissions points. The total estimated capital cost for the new baghouses is \$7.7 million, resulting in an annualized capital cost of \$0.7 million. Additional annual operational and maintenance costs, including more frequent bag changes for the baghouses, are

estimated at \$0.9 million above the currently operated air pollution control device operating costs. The total annualized cost above current cost for the three baghouses is \$1.7 million (2009 dollars). Lead emissions reductions for this option are estimated at 4.7 tons per year with total metal HAP emissions reductions of 5.9 tons per year.

d. Option 4S

Option 4S is a regulatory option that considers requiring installation of a wet electrostatic precipitator (WESP) at each facility to control stack emissions of metal HAP. One facility in this source category currently utilizes a WESP to control metal HAP emissions from stacks (i.e., Quemetco, Inc. in City of Industry, CA). Based on emissions data received in the ICR, this facility is the lowest emitting facility in terms of stack emissions of metal HAP. In this option, the other 13 facilities in the source category would be required to install a WESP. Based on the configuration of the existing WESP reported in the ICR, we assumed that facilities that would need to install a WESP under this option would use the WESP to control metal HAP emissions from process and process fugitive emissions sources only. More specifically, we assumed that existing hygiene baghouses would not be routed to the WESP. The total estimated capital cost for installation of a WESP at 13 facilities is \$400 million, resulting in an annualized capital cost of \$36 million. The total annualized cost above current cost is estimated at \$55 million. Lead emissions reductions for this option are estimated at 10.9 tons per year with total estimated metal HAP emissions reductions of 13.8 tons per year.

e. Summary

A summary of the costs and emissions reductions associated with the four regulatory options described above for stack emissions are summarized in Table 2-1.

Table 2-1: Estimated Costs and Emissions Reductions for the Regulatory Options Considered for Stack Emissions of Metal HAP.

Option	Description	COST IN \$ MILLIONS (2009 DOLLARS)				Total HAP Emissions Reductions (tons per year)	Cost per ton HAP reduction (\$MM)
		Capital Cost	Annualized Capital Cost	Annual Operation and Maintenance Cost	Total Annualized Cost		
1S	Concentration limit of 0.5 mg/dscm	\$11.8	\$1.1	\$1.6	\$2.7	8.3	\$0.33
2S	0.009 lb Pb / Ton Pb produced	\$23.9	\$2.3	\$2.7	\$5.0	9.6	\$0.52
3S	Concentration limit of 1.0 mg/dscm any stack, and 0.2	\$7.7	\$0.7	\$0.9	\$1.7	5.9	\$0.29

Option	Description	COST IN \$ MILLIONS (2009 DOLLARS)				Total HAP Emissions Reductions (tons per year)	Cost per ton HAP reduction (\$MM)
		Capital Cost	Annualized Capital Cost	Annual Operation and Maintenance Cost	Total Annualized Cost		
	mg/dscm facility average						
4S	WESP	\$400	\$36	\$19	\$55	13.8	\$4.0

2.2 Stack Emissions – Organic HAP and D/F

The two regulatory options considered for control of stack emissions of organic HAP and D/F are presented in the following sections.

a. *Option 1D*

Option 1D is the regulatory option that EPA chose for proposal in the revised NESHAP for the Secondary Lead Smelting source category. This option represents calculating a MACT floor for D/F emissions from various furnace groupings that were formed based on similar operating characteristics. In addition to the D/F MACT floors, new MACT floors for THC were calculated for furnace types that are not regulated in the existing NESHAP. These include reverberatory furnaces not collocated with blast furnaces, electric arc furnaces, and rotary furnaces. The THC MACT limits for blast furnaces and collocated blast and reverberatory furnaces in the existing NESHAP would remain unchanged under the proposed revisions. We do not anticipate that this regulatory option will require installation of additional controls at any facilities. We do anticipate, however, that four facilities operating blast furnaces will likely increase the temperature of their afterburners to ensure continuous compliance with the new MACT floors for D/F and THC. The cost of the natural gas required to raise the temperature 100 degrees Fahrenheit (°F) at afterburners was estimated at \$260,000 per year (2009 dollars). Under this regulatory option, we estimate D/F emissions reductions of about 2.9 grams per year and organic HAP emissions reductions of about 30 tons per year.

b. *Option 2D*

Option 2D represents a beyond-the-floor option for D/F emissions from blast furnaces that are not collocated with reverberatory furnaces. This option was considered because based on emissions data submitted in the ICR, blast furnaces that are not collocated with reverberatory furnaces contribute approximately 78 percent of the total D/F emissions from the source category. In this option, a Toxic Equivalency Quotient (TEQ) based concentration limit of 17 nanograms per dry standard cubic meter (ng/dscm) (corrected to 7 percent oxygen (O₂)) was

considered. This concentration represents an approximate 90 percent reduction in total D/F emissions from blast furnaces in this source category.

For this option, we assumed that additional afterburner capacity would be needed at five of the six blast furnaces needing D/F emissions reductions. One of the blast furnaces has an afterburner currently installed that meets the requirements of this considered regulatory option. The total estimated capital cost for installation of the additional afterburners is \$5.9 million, which results in an estimated annualized capital cost of \$0.56 million. Annual operational and maintenance costs increases, including additional natural gas fuel, are estimated at \$2.4 million above current control device operating costs. The total annualized cost above current cost for the afterburners is estimated to be \$2.9 million (2009 dollars). Under this scenario, we anticipate D/F emissions reductions of 31 grams per year, with a co-reduction of 200 tons per year of all other organic HAP. We also estimate that this option would result in a significant increase in fuel use along with increased emissions of carbon dioxide (CO₂) and oxides of nitrogen (NO_x) associated with operation of the additional afterburners.

c. Summary

A summary of the costs and emissions reductions associated with the two regulatory described above for D/F and organic HAP emissions are summarized in Table 1-4.

Table 2-2: Cost Estimates and Emissions Reductions for Regulatory Options Considered for Stack Emissions of D/F and Organic HAP.

Option	Description	COST IN \$ MILLIONS (2009 DOLLARS)				Total HAP Emissions Reductions (tons per year)	Cost per ton HAP reduction (\$MM)
		Capital Cost	Annualized Capital Cost	Annual Operation and Maintenance Cost	Total Annualized Cost		
1D	Concentration based MACT limit	\$0	\$0	\$0.26	\$0.26	30*	\$0.009
2D	Beyond the floor for Blast furnaces	\$5.9	\$0.56	\$2.4	\$2.9	200*	\$0.015

* based on total organic HAP

2.3 Fugitive Emissions – Metal HAP

Three regulatory options were considered for control of fugitive metal HAP emissions. Because these emissions cannot be directly measured, a numerical emissions limit was not calculated. Instead, regulatory options were considered that prescribed specific controls or lead

compliance monitoring at the property boundary as a means of demonstrating compliance. The three options considered are as follows:

1. **Option 1F:** This option requires facilities to conduct ambient lead monitoring at or near the property boundary to demonstrate compliance with the National Ambient Air Quality Standard (NAAQS) for lead.
2. **Option 2F:** This option requires facilities to keep all lead-bearing materials and processes enclosed in permanent total enclosures that are vented to a control device. Additional fugitive control work practices would also be required. Compliance with this regulatory option would be demonstrated by ensuring full enclosure plus work practices and ambient lead monitoring at or near the property boundary.
3. **Option 3F:** This is the primary regulatory option selected by EPA for proposal in the revised NESHAP for the Secondary Lead Smelting source category. This option is identical to option 2F with the exception that ambient lead monitoring at or near the boundaries of the facilities would not be required. Instead, compliance would be demonstrated through construction of total enclosures and operation according to a standard operating procedures (SOP) manual detailing how the required fugitive control work practices will be implemented.

In options 2F and 3F, facilities would be required to have all lead manufacturing processes within total enclosures under negative pressure with conveyance to a control device. Although option 1F requires only monitoring at the property boundary, and does not explicitly require total enclosures, we assumed for cost purposes that facilities would need to operate all lead-bearing processes under negative pressure enclosures in order to comply with this option. This estimate is considered to be a high end conservative estimate of costs, particularly for facilities where operations are not close to the property boundary. Based on information submitted in the ICR, the facilities that are currently achieving ambient lead concentrations at or near the lead NAAQS at or near their property's boundaries are facilities that already have their processes totally enclosed. Therefore, we assumed facilities that do not have all of their lead manufacturing processes in total enclosures will construct the appropriate enclosures and reconfigure their facilities to reduce their overall footprint as described in section 3.3 of this memorandum.

The total estimated capital cost for the total enclosures, ventilation systems, and associated control devices is \$40 million, which results in an annualized capital cost of \$3.8 million. The total annual operation and maintenance cost, which includes building and baghouse maintenance, is estimated at \$2.8 million above current cost. The total annualized cost of new enclosures for six facilities is \$6.6 million. Costs associated with the additional work practices are estimated at \$300,000 per facility for 10 facilities at a total cost of \$3 million. The total estimated annualized cost of reducing fugitive emissions for the primary regulatory option selected by EPA for proposal (Option 3F) is \$9.6 million (2009 dollars). For option 1F and 2F, the cost of operating two compliance monitors at or near the property boundary of each facility is

estimated at \$23,000 per facility for a total additional annualized cost of \$322,000. We estimate reductions in fugitive emissions of 8.7 tons per year of lead and 9.5 tons per year of metal HAP.

The estimated costs and emissions reductions associated with the regulatory options considered for fugitive emissions of metal HAP are summarized in Table 1-5.

Table 2-3: The Estimated Costs and Metal HAP Reductions for Fugitive Sources

Option	Description	COST IN \$ MILLIONS (2009 DOLLARS)				Total HAP Emissions Reductions (tons per year)	Cost per ton HAP reduction (\$MM)
		Capital Cost	Annualized Capital Cost	Annual Operation and Maintenance Cost	Total Annualized Cost		
1F and 2F	Enclosure, work practice, monitoring	\$40	\$3.8	\$6.1	\$9.9	9.5	\$1.04
3 F	Enclosure, work practice	\$40	\$3.8	\$5.8	\$9.6	9.5	\$1.0

3.0 METHODOLOGY FOR ESTIMATING CONTROL COSTS

The following sections present the methodologies used to estimate the costs associated with the regulatory options considered for proposal in the revised NESHAP for the Secondary Lead Smelting source category.

3.1 Stack Emissions – Metal HAP

The primary technologies used to control stack emissions of metal HAP in the Secondary Lead Smelting source category are filtration devices such as baghouses or cartridge collectors, some of which have high performance particulate air (HEPA) filters as a secondary filtration device. One facility uses a wet electrostatic precipitator (WESP) downstream of a baghouse as a polishing step to further reduce metal HAP emissions. Data collected in the ICR indicate that baghouses that are properly designed, installed, maintained and operated can meet all of the metal HAP stack emissions limits considered in this analysis except those under option 4S (which included a WESP).

In order to estimate the capital cost associated with a particular option, we first determined which stacks would be required to reduce emissions. For the concentration-based limits, we assumed that the baghouses at any stacks reporting concentrations in the ICR above the considered emissions limit would need to be repaired, improved, or replaced. If the reported concentration was more than 10 percent over the considered limit, we assumed the baghouse would need to be replaced. If the reported concentration was within 10 percent of the considered limit or the unit in question was relatively new (installed after the year 2000), we assumed that

replacement bags or additional baghouse maintenance could sufficiently reduce the concentration. For options that included a flow-weighted average concentration limit or a production based emissions limit, control devices were chosen for replacement or upgrade one at a time, beginning with the highest reported lead concentration, until the facility's emissions were below the considered limit.

In the ICR, EPA requested information on costs of emissions control devices that have been installed in the last five years. Several facilities submitted cost information that was used as a basis for estimating the cost associated with installation of a new baghouse. We compared estimates submitted by all of the facilities and chose the highest of the estimates as the cost model for baghouse installations. We compared estimates using this methodology to estimates derived using techniques described in the sixth edition of the EPA Air Pollution Control Cost Manual (http://www.epa.gov/oaqps001/lead/pdfs/2002_01_cost_control_%20manual.pdf). While the estimates derived using the EPA's manual were higher, we believe using data submitted directly by the industry is likely more representative of actual costs incurred by this source category.

Our cost model included installation of the baghouse and any necessary fans, ductwork, screw conveyors, and site work for each scenario, as appropriate. All costs are based on 2009 dollars. We did not consider the associated downtime for the unit in our costs. We estimated capital costs on the basis of dollars per unit of air flow (i.e., cubic foot per minute) into the device and assumed linearity of cost within the range of air flows considered in our analysis. The total installed capital cost of a typical baghouse designed for a flow-rate of 80,000 actual cubic feet per minute (acfm) was estimated at \$1.4 million. This cost assumes a 20 year life expectancy for the unit and, to be consistent with OMB Guidance in Circular A-4, a seven percent cost of capital as an estimate of the annualized capital cost. The design flow-rate for a baghouse was assumed to be 20 percent higher than the flow-rate measured during a compliance test.

The major operating cost of a baghouse is associated with routine replacements of the filter media (bags). The number of compartments in the baghouse and the number of bags per compartment were estimated using either data submitted in the ICR for the particular unit or data submitted for a similar sized unit if the former data were not available. The estimated number of bags was used to calculate the ongoing maintenance cost of replacing bags. We assumed that facilities would be required to replace bags every two years for the devices that reported emissions above the considered limit. The cost of a replacement bag was estimated at \$200 based on information submitted in the ICR. Other operating and maintenance costs were developed using information submitted in the ICR.

For the WESP option, we used information submitted by Quemetco, Inc. in the ICR as a basis for estimating cost. We assumed that the configuration of the new WESP installations would be similar to that of Quemetco. More specifically, we assumed that facilities would use the WESP to control process and process fugitive emissions sources, but not general building ventilation sources. We used the rapid estimation exponential method described in Perry's Chemical Engineers' Handbook³ to derive an equation representing the expected flow-rate into the WESP at each facility. Our estimate of annualized costs primarily includes electricity to operate the WESP and capital recovery.

3.2 Stack Emissions – Organic HAP and D/F

The formation of D/F occurs in the smelting furnaces and is highly dependent on the operating temperature of the furnace. Very small amounts of D/F were detected in the emissions streams of reverberatory furnaces; higher amounts were detected in the emissions streams of blast furnaces that were not collocated with reverberatory furnaces. Emissions data submitted in the ICR indicate that D/F emissions from collocated blast and reverberatory furnaces are lower than those from blast furnaces not collocated with reverberatory furnaces, indicating that comingling the flue gas streams of a blast furnace with the hotter stream of the reverberatory furnace is an effective D/F control option. Based on information submitted in the ICR, temperatures of the reverberatory stream are typically around 2200°F, likely high enough to raise the overall temperature of the combined blast and reverberatory furnace stream to that typically achieved by an afterburner. Studies of D/F destruction indicate that properly designed and operated afterburners with a sufficient residence time can achieve high destruction efficiency⁴. The majority of the blast furnaces in this source category that are not collocated with reverberatory furnaces use afterburners as a means of controlling organic HAP emissions. However, based on information submitted in the ICR, the majority of these afterburners are not operated at temperatures necessary for efficient destruction of D/F. We estimated that an afterburner operating at 1600°F with a residence time of 2.5 seconds or longer would achieve a 90 percent reduction in D/F emissions.

In order to estimate the capital cost of 90 percent control efficiency for D/F from blast furnaces, information contained in the ICR responses was used to determine the current furnace and afterburner temperature and residence time. We assumed that an existing afterburner would have the capability to increase the operating temperature 100°F without a major modification. Based on information submitted in the ICR, we determined that 5 of the 6 afterburners controlling blast furnaces (not collocated with reverberatory furnaces) in this source category

³ Perry, Robert H & Green, Don W. (1984). *Perry's Chemical Engineers' Handbook*, (6th ed.). McGraw-Hill.

⁴ Ficarella, Antonio and Laforgia, Domenico. Numerical simulation of flow-field and dioxins chemistry for incineration plants and experimental investigation, *Waste Management* 20 (2000) 27-49.

were not capable of achieving a temperature of 1600°F. Therefore, we estimated the capital and operating costs associated with installation of a new afterburner for these sources. Three facilities submitted cost data in the ICR for afterburner installations; the highest of the three estimates was chosen as the basis for our cost estimate. For the capital cost estimate, we assumed that the existing afterburner would remain in place and a new afterburner capable of increasing the temperature of the stream leaving the existing afterburner to a temperature of 1600°F would be installed. We used an equation modeled after equation 2.32 in the EPA Air Pollution Control Cost Manual to scale the size and cost of a thermal incinerator based on the reported flow-rates for each of the blast furnaces. The typical cost for an installed afterburner with a design flow-rate of 17,000 acfm was estimated at \$1.2 million.

The annual cost of operating an afterburner was estimated using the approach described in the EPA Air Pollution Control Cost Manual. The cost of additional fuel required to increase the operating temperature of the afterburners was estimated based on the estimated amount of required natural gas. Other operating and maintenance costs were estimated using an approach described in EPA Air Pollution Control Cost Manual. The annual capital cost was estimated using a 20 year equipment life and a 7 percent interest rate.

3.3 Fugitive Emissions – Metal HAP

There are two general categories of fugitive emissions of metal HAP at a secondary lead facility: process fugitive emissions and fugitive dust emissions from material handling operations and re-entrainment of deposited dust. Process fugitive emissions result from furnace leaks and incomplete capture of emissions during tapping and charging of smelting furnaces. Charge materials contain fine lead-bearing particles that can be liberated during charging operations. Furnace upsets, particularly those caused by wet feed material, can result in overpressure of the smelting furnace. This may cause release of emissions that would normally be contained by negative pressure occurring inside the smelting furnaces. Process fugitive emissions can also result from incomplete capture of emissions at battery breakers, dryers, and refining and casting operations. Fugitive dust emissions can be generated during material handling operations. Lead bearing materials are transported throughout the plant in areas that may be open to the atmosphere. During transport, the material can spill or leak from the transport vehicles and settle on the floors and yards of the facilities. Wind, vehicle traffic, and other forces can then re-entrain the deposited dust as fine airborne particles. Stack emissions containing lead and other metal HAP can also settle onto surfaces near the facility and can be subsequently re-entrained as fine airborne particles.

The current MACT standard for control of fugitive emissions of metal HAP from secondary lead smelters requires process fugitive emissions sources to be captured by negative pressure enclosure hoods and vented to a control device. There is a minimum face velocity

requirement for the enclosure hoods that varies based on the emissions source. As an alternative to an enclosure hood requirement, the facility may operate the process fugitive emissions source in a building that is maintained at a lower than ambient pressure. The building ventilation air is required to be conveyed to a control device. Additional fugitive control work practice requirements in the current MACT standard include wetting of storage piles, cleaning of roadways, and washing of vehicles prior to leaving any areas where lead-bearing materials are handled.

EPA requested information in the ICR regarding the fugitive control techniques employed at each facility. Based on that information, we assessed the relative effectiveness of the controls implemented by each facility and estimated fugitive emissions at each facility based on that assessment (see Draft Development of the RTR Emissions Dataset for the Secondary Lead Smelting Source Category for more details). The facilities achieving low ambient lead concentrations at nearby monitors were assumed to achieve more efficient control of fugitive emissions. We assumed that facilities with ambient monitoring data showing lead concentrations above the lead NAAQS would need to install permanent total enclosures with ventilation to a control device and implement additional work practices to prevent the formation of fugitive dust in other areas of their facilities. This approach may overstate the costs for facilities that choose to demonstrate compliance through monitoring at the property boundary, and where operations are a significant distance from the property boundary.

For each facility, we estimated the area that is currently under a total enclosure ventilated to a control device. We then estimated the additional enclosure area necessary fully enclose the entire process. We assumed facilities that required a substantial area of new enclosures would re-configure their facility in a manner that reduces the overall footprint of the facility.

Enclosure costs were estimated using the EPA Air Pollution Control Cost Manual. We used the 2008 version of the Air Compliance Advisor (ACA) program, a program developed by the EPA to facilitate the calculations required in the EPA Air Pollution Control Cost Manual, to estimate the cost of the building. The costs were then adjusted to 2009 dollars. The costs considered sheet metal walls, 30 feet high interior, automatic roll-up doors, louvers, make up air fans, ductwork, pressure monitors, and smoke detectors. We ran the ACA program for two model buildings. The average building capital cost based on these two runs was estimated at \$40 per square foot. This factor was used to estimate the cost of the additional enclosure area required for all other facilities.

The capital cost of the control devices required to control the enclosure ventilation air was estimated based on the flow-rate required to maintain the building under sufficient negative pressure. Based on information submitted in the ICR, we estimated a flow-rate that would result

in an air turnover rate of five per hour in a building maintained under sufficient negative pressure. We estimated the cost of the baghouse using the methodology described in section 3.1 of this memorandum.

Annualized costs for the enclosures and associated baghouses were based on a 20 year life expectancy and 7 percent cost of capital. Annual operating costs for the baghouse were estimated based on data obtained in the ICR. We chose this methodology because we believed it to be more representative of actual operation and maintenance costs for this situation. Additional operating and maintenance costs were estimated for the enclosures using guidelines supplied in the EPA Air Pollution Control Cost Manual.

We calculated annual costs for required installation of two compliance monitors at the property boundary for each facility under regulatory options 1F and 2F. The monitoring costs were obtained from estimates made for similar monitors in the proposed revisions to the Primary Lead Smelting NESHAP, published February 17, 2011 (76 FR 94106).

We anticipate that the work practices specified in the existing Secondary Lead Smelting NESHAP will not be adequate to maintain fugitive emissions from this source category at an acceptable level. We estimated that an additional four employees per facility (one per shift for four shifts) at an annualized cost of \$300,000 will be needed to implement the following additional fugitive control work practices: maintenance of negative pressure monitors in enclosures, monthly cleaning of rooftops, weekly cleaning of all areas where waste generated by housekeeping activities are stored or disposed of, immediate cleaning after accidental releases, inspections of enclosures once per month, daily inspection of battery storage area and immediate processing of cracked batteries, and thorough cleaning and inspection of any vehicles leaving the process area.

4.0 METHODOLOGY FOR ESTIMATING EMISSIONS REDUCTIONS

This section discusses the methodology used to estimate emissions reductions associated with the control options presented in sections 1.0 and 2.0 of this memorandum.

4.1 Stack Emissions – Metal HAP

a. Option 1S

For Option 1S, the outlet lead concentration reported for each stack in the ICR was compared to the limit considered in this regulatory option (i.e., 0.5 mg/dscm). If the reported concentration was above 0.5 mg/dscm, we assumed that the facility would need to install a new baghouse at that emissions point. We assumed that the outlet lead concentration from the newly installed baghouse would be equivalent to the average of all outlet lead concentrations reported

in the ICR; we calculated this average to be 0.159 mg/dscm. We estimated the expected reduction in emissions as the difference between current stack emissions and the emissions that would occur assuming an outlet lead concentration of 0.159 mg/dscm (see Equation 1).

$$\text{Emissions Reduction} = [(C_i \times F) - (0.159 \times F)] \times H \times T \quad (\text{Eq. 1})$$

Where:

C_i = outlet lead concentration reported in the ICR (mg/dscm),

F = flow rate (dscm/hr),

0.159 = expected outlet lead concentration of new baghouse (mg/dscm),

H = annual hours of operation, and

T = conversion factor for milligrams to tons (1.1×10^{-9}).

We concluded that 8 stacks throughout the industry would need new baghouse installations. One additional source reported an outlet lead concentration above 0.5 mg/dscm. However, they reported an ongoing project that includes upgrading the baghouse in question, and therefore, this source was not included in the emissions reduction calculation.

b. Option 2S

For option 2S, the stack lead emissions reported by each facility in the ICR were summed and divided by the annual lead production (average of 2008 and 2009) reported in the ICR. A statistical equation that considered variability in emissions was used to calculate a production based emissions limit of 0.009 lb/ton Pb. Based on emissions data received in the ICR, six facilities' emissions were above 0.009 lb/ton Pb. We assumed that these six facilities would sequentially replace or improve their existing baghouses one-by-one, starting with the units reporting the highest lead concentrations, until the facility's emissions were below 0.009 lb/ton Pb. Similar to option 1S, we assumed that a new baghouse could achieve an outlet lead concentration of 0.159 mg/dscm. We estimated that a total of 20 emissions points at six facilities would require reductions in lead emissions in this option. Total emissions reductions were calculated using Equation 1. We assumed emissions of other metal HAP would be reduced proportionally to lead emissions.

c. Option 3S

For Option 3S, we considered a facility-wide flow-weighted average lead concentration limit of 0.2 mg/dscm as well as a maximum lead concentration limit of 1.0 mg/dscm applicable to any individual stack. We calculated emissions reductions associated with the maximum concentration limit of 1.0 mg/dscm using a modified form of Equation 1. Based on this analysis, we estimated that three stacks would need replacement baghouses. Additionally, each facility's flow-weighted average lead concentration was calculated based on emissions data submitted in

the ICR. We then compared that value to facility-wide flow-weighted average limit of 0.2 mg/dscm considered in this option. We estimate that five facilities currently have a flow-weighted average lead concentration above the considered limit. We also considered the impacts of the proposed fugitive control standards presented in section 2.3 of this memorandum on the flow-weighted average concentration of each facility. Because we assumed that each facility will be required to have all processes under total enclosures with negative pressure and ventilation to a control device, we assumed that facilities needing additional enclosures would install one additional corresponding hygiene baghouse. Based on the average outlet lead concentration reported in the ICR for similar sources, we assumed that the outlet lead concentration from these hygiene baghouses would be 0.05 mg/dscm. We estimated that three of the five facilities initially identified as having emissions above the limit considered in this option would meet the considered limit after installation of the additional enclosures required in the fugitive control options. Furthermore, we estimate that replacing all baghouses reporting concentrations above 1.0 mg/dscm in combination with the installation of additional enclosures will result in all facilities being in compliance with the limits considered in this option. The total emissions reductions for this option were calculated using Equation 1.

d. Option 4S

For option 4S, we estimated emissions reductions of lead and other metal HAP using information submitted by Quemetco, Inc. regarding the efficiency of the WESP at their facility. Based on this information, we assumed that emissions of lead and other metal HAP from any source expected to be controlled by the WESP would be reduced by 99.98 percent.

4.2 Stack Emissions – Organic HAP and D/F

a. Option 1D

Option 1D considers MACT floor emissions limits for D/F (TEQ) based on furnace type. This option also includes setting MACT floor emissions limits for THC for furnace types that are not regulated in the existing NESHAP (i.e., reverberatory furnaces not collocated with a blast furnace, rotary furnaces, and electric furnaces). Based on our MACT floor calculation (see Draft MACT Floor Analysis for the Secondary Lead Smelting Source Category), we do not anticipate significant D/F or organic HAP emissions reductions associated with this option. However, we assume that facilities operating afterburners will likely increase the operating temperatures to ensure continuous compliance with the considered D/F limit. We believe reduction in D/F and other organic HAP on the order of 10 percent are possible using this assumption.

b. Option 2D

Option 2D is a beyond-the-floor option for D/F that establishes a TEQ concentration limit of 17 ng/dscm for blast furnaces not collocated with a reverberatory furnace. Based on the study reference in section 3.2 of this memorandum, the D/F destruction efficiency of an afterburner operating at 1600°F with a residence time of 2.0 – 2.5 seconds is between 90 and 94 percent. For the purposes of calculating emissions reductions associated with this option, we assumed a 90 percent destruction efficiency of D/F and organic HAP for newly installed afterburners in this source category.

4.3 Fugitive Emissions – Metal HAP

For all the fugitive emissions control options considered, we assumed that all facilities would need to reduce their fugitive emissions to a level that would reduce ambient lead concentrations near their property boundary to levels below the lead NAAQS.

We derived factors to estimate the reductions in fugitive emissions that are likely to occur as a result of enclosing all manufacturing processes material handling operations. Reductions in fugitive emissions of 75 percent from baseline levels were estimated if new total enclosures were installed at a facility where only partial enclosures currently exist. Additional reductions of 80 percent (total reductions of 95 percent) were estimated as a result of implementation of the additional work practices described in section 3.3 of this memorandum. This methodology is described in detail in the Draft Development of the RTR Emissions Dataset for the Secondary Lead Smelting Source Category.

5.0 TESTING AND MONITORING COST IMPACTS

The existing NESHAP requires annual stack testing for lead and allows for reducing stack testing to every two years if the measured lead concentrations are below 1.0 mg/dscm. The regulatory options chosen for proposal in the revised NESHAP require annual stack testing for lead and THC and stack testing once every five years for D/F. The additional costs associated with the stack testing requirements above current costs are anticipated to be \$750,000 per year (an average of \$53,000 per facility).

Bag leak detection systems (BLDS) are required by the existing NESHAP for all baghouses unless a secondary HEPA filter is installed. The proposed revisions to the NESHAP eliminate the BLDS exemption for emissions points where secondary HEPA filters are installed. The capital cost associated with installation of seven new BLDS is \$230,000 and was estimated using the EPA's bag leak detection guidance⁵ and CEMS cost model (<http://www.epa.gov/ttn/emc/cem.html>). The capital cost associated with additional differential pressure monitors for total enclosures is \$97,000.

⁵ EPA Office of Air Quality Planning and Standards Fabric Filter Bag Leak Detection Guidance – (EPA 454/R-98-015).

The total estimated annualized cost for additional testing, monitoring, recordkeeping, and reporting considering the first three years after the proposed revisions are implemented is \$1,020,000. A detailed burden estimate is available in the docket for this rulemaking (*Supporting Statement, National Emission Standards for Secondary Lead Smelting*).

6.0 SUMMARY OF COST BY FACILITY

Table 6-1 is a summary of estimated costs for each of the facilities in the secondary lead smelting source category.

Table 6-1 Summary Cost Estimates by Facility*

Facility	Total Capital Cost	Total Annual Cost
Doe Run	18,200,000	3,550,000
East penn	0	380,000
EnviroFocus	0	390,000
Exide Baton Rouge	7,250,000	1,890,000
Exide Forest City	2,560,000	750,000
Exide Frisco	4,390,000	1,160,000
Exide Muncie	0	360,000
Exide Reading	5,630,000	1,320,000
Exide Vernon	0	87,000
Gopher Eagan	0	350,000
Quemetco (CA)	0	87,000
Quemetco (IN)	0	94,000
RSR	0	87,000
Sanders	9,520,000	2,048,000
Total	47,550,000	12,553,000

*Some of these cost estimates are likely overstated since some facilities may be able to comply with the rule under the alternative compliance option (i.e., monitoring at facility boundary and implementing work practices) and may not need to construct full enclosures. If so, actual costs would be significantly lower than shown here for those facilities.

SourceFile	BaghouseControl EquipmentID	ControlDevic elnstallation Year	InletGasFlowRate_dscfm	NumberOf Compartments	NumberOfBags OrCartridgesPerCompartment	Capital cost Estimate	Annualized Capital cost	Additional Annual O&M	Bag Replacement cost	Total Annualized cost over current cost	Capital cost Estimate by facility	Annualized Capital cost by Facility	Annual O&M by Facility	Bag Replacement cost by Facility	Total Facility Annualized cost above current cost
Buick RRF	CD8-EP08	1967	325,000	14	416	5,625,750	531,031	156,000	349,440	1,036,471					
Buick RRF	CD27-EP71	2003	60,000	4	256	259,650	24,509	28,800	61,440	114,749					
Buick RRF	EP-73		27,166	3	352	470,237	44,387	13,039	63,360	120,786					
Buick RRF	EP-16		33,985	3	352	588,284	55,530	16,313	63,360	135,203	6,943,920	655,457	214,152	537,600	1,407,209
East Penn	S202		30,000	1	384		-	14,400	23,040	37,440	-	-	14,400	23,040	37,440
Exide Frisco	HARDLEADBH	1978	25,616	4	216	443,420	41,856	12,296	51,840	105,992					
Exide Frisco	SPECALLOY	1978	74,382	3	216	1,287,552	121,536	35,703	38,880	196,119					
Exide Frisco	SOFTLEADBH	1978	52,093	6	288	901,733	85,117	25,005	103,680	213,802					
Exide Frisco	NewBLAST-Reverb	1969	62,401	5	200	1,080,165	101,960	29,953	60,000	191,912					
Exide Frisco	FURNFUG	?	113,167	6	288	1,958,924	184,909	54,320	103,680	342,909					
Exide Frisco	RMSTG	?	91,883	8	288	1,590,491	150,131	44,104	138,240	332,475					
Exide Frisco	Dryer BH	?	20,000	4	216		-	9,600	51,840	61,440	7,262,286	685,508	210,981	548,160	1,444,649
Exide Baton Rouge	#1 BH	1973	90,000	10	528	1557900	147,055	43,200	316,800	507,055					
Exide Baton Rouge	#4 BH	1977	45,000	8	288	778,950	73,527	21,600	138,240	233,367					
Exide Baton Rouge	#5 BH	1979	35,000	3	352	605850	57,188	16,800	63,360	137,348	2,942,700	277,770	81,600	518,400	877,770
Exide Reading	C22	1984	80,000	4	264	1,384,800	130,715	38,400	63,360	232,475					
Exide Reading	C11		60,000	5	80	1,038,600	98,036	28,800	24,000	150,836					
Exide Reading	C19		74,945	5	80	1,297,294	122,455	35,974	24,000	182,429					
Exide Reading	C47	2000	84,000	5	276	1,454,040	137,251	40,320	82,800	260,371	5,174,734	488,458	143,494	194,160	826,112
Sanders	BH 1	1970	90,720	10	288	1,570,363	148,231	43,546	172,800	364,577	1,570,363	148,231	43,546	172,800	364,577
					average	1,327,445									
					Total	23,894,004	2,255,425	708,172	1,994,160	4,957,757	23,894,004	2,255,425	708,172	1,994,160	4,957,757

Note: East Penn is not currently within the limit established, however one baghouse had a test with much higher values than previous test. Assume East Penn needs only additional maintenance or bag replacement.

Assumptions:

Costs calculated for limit based on 0.009 lb lead emissions per ton product

Facilities listed would need upgrade/ replacement of existing baghouses

Baghouses selected based on emission rate needed to comply with lb/ton limit

Survey data used for flowrate, number of compartments and number of bags

Cost for baghouses were derived from data submitted in survey - Model facility used

Annualized cost assumes 7% cost of capital, 20 year life

Annual O&M cost derived from data submitted in survey. Compared with cost of replacing bags at \$200/bag for teflon on teflon bag, cost seems reasonable, estimated additional O&M over current is 25%

For cost over current cost of operating a baghouse, estimated that bags would be changed more often than current (2 years vs 5)

Facilities would meet the revised Lead limit for facility wide emissions

Option 1S Conc 0.5

SourceFile	BaghouseControlEquipmentID	ControlDeviceInstallationYear	Pb Conc	Pb Emissions TPY	Anticipated Pb Emission Reduction	InletGasFlowRate_acfm	NumberOfCompartments	NumberOfBagsOrCartridgesPerCompartment	Capital cost Estimate	Annualized Capital cost	Additional Annual O&M	Bag Replacement cost	Total Annualized cost over current cost	cost Effectiveness \$/ton HAP
Buick RRF	CD8-EP08	1967	1.19	3.46	3.0	325000	14	416	5,625,750	531,031	156,000	349,440	1,036,471	
Buick RRF	EP-73		1.27	0.43	0.4	27166	3	352	470,237	44,387	13,039	63,360	120,786	
Buick RRF	EP-16		0.53	0.22	0.2	33985	3	352	588,284	55,530	16,313	63,360	135,203	
Exide Frisco	Feed Dryer	2007	0.585	0.54	0.4	81197	4	216		-	38,974	51,840	90,814	
Exide Baton Rouge	#1 BH	1973	1.26	1.49	1.3	90000	10	528	1,557,900	147,055	43,200	316,800	507,055	
Exide Baton Rouge	EP93-3		0.506	0.34	0.2	44208	3	458		-	21,220	82,419	103,639	
Exide Reading	C22	1984	0.657	0.39	0.3	80000	4	264	1,384,800	130,715	38,400	63,360	232,475	
Sanders	BH 1	1970	0.619	0.72	0.5	90720	10	288	1,570,363	148,231	43,546	172,800	364,577	
Sanders	BH4		0.723	0.31	0.2	35000	3	352	605,850	57,188	16,800	63,360	137,348	
									-	-	0	0	0	
			Total	7.9	6.5				11,803,184	1,114,137	387,492	1,226,739	2,728,368	329,752
					8.3	Total Metal HAP reduction								

Option 1S- Concentration limit established at about 0.5 mg/dscm

Assumptions:

Facilities listed would need upgrade/ replacement of existing baghouses

Survey data used for existing baghouses at facilities.

Cost for baghouses were derived from data submitted in survey - Model facility used

Annualized cost assumes 7% cost of capital, 20 year life

Annual O&M cost derived from data submitted in survey. Added to cost of replacing bags at \$200/bag for teflon on teflon bag, estimated additional O&M over current is 25%

For cost over current cost of operating a baghouse, estimated that bags would be changed more often than current (2 years vs 5)

Baghouses chosen for replacement would allow facilities to meet proposed concentration limit

average lead concentration from all stacks is 0.159, assumption for emission reduction is based on achieving this concentration

SourceFile	BaghouseControlEquipmentID	ControlDeviceInstallationYear	Pb Conc	Pb Emissions TPY	Emission Reduction	InletGasFlowRate_acfm	NumberOfCompartments	NumberOfBagsOrCartridgesPerCompartment	Capital cost Estimate	Annualized Capital cost	Additional Annual O&M	Bag Replacement cost	Total Annualized cost over current cost	cost Effectiveness \$/ton HAP
Buick RRF	CD8-EP08	1967	1.19	3.46	3.0	325,000	14	416	5,625,750	531,031	156,000	349,440	1,036,471	
Buick RRF	EP-73		1.27	0.43	0.4	27,166	3	352	470,237	44,387	13,039	63,360	120,786	
Exide Baton Rouge	#1 BH	1973	1.26	1.49	1.3	90,000	10	528	1,557,900	147,055	43,200	316,800	507,055	
				5.4	4.7			Total	7,653,887	722,473	212,239	729,600	1,664,312	\$ 280,690

Scenario- 1.0 mg/dscm limit and 0.3 mg/dscm average

Metal HAP reduction assuming 5.92

Assumptions:

Facilities listed would need upgrade/ replacement of existing baghouses

Survey data used for existing baghouses at facilities.

Cost for baghouses were derived from data submitted in survey - Model facility used (see tab Baghouse cost)

Annualized cost assumes 7% cost of capital, 20 year life

Annual O&M cost derived from data submitted in survey. Compared with cost of replacing bags at \$200/bag for teflon on teflon bag, estimated additional O&M over current is 25%

For cost over current cost of operating a baghouse, estimated that bags would be changed more often than current (2 years vs 5)

Facilities would meet the revised Lead MACT floor for facility wide emissions

average lead concentration from all stacks is 0.159, an alternate assumption for emission reduction is based on achieving this concentration

Option 3F Fugitive Control Cost

Facility	Total Enclosed Area Needed ft2	Building Capital Cost	New CF to be ventilated	Baghouse Capital (\$)	Total Capital cost	Annualized Capital cost Baghouse + building	Baghouse Annual Operating cost(\$)	Enclosure Annual operating cost	Enclosure and baghouse operating cost	Enclosure and baghouse total Annual cost	Work practice estimate	Annual Operation and Maintenance cost (total)	Total Annual cost
Exide Baton Rouge	66,488	2,659,514	1,994,636	3,031,846	5,691,360	537,224	337,093	66,488	403,581	940,805	300,000	703,581	1,240,805
Exide Forest City	29,880	1,195,185	896,389	1,362,511	2,557,696	241,428	151,490	29,880	181,369	422,798	300,000	481,369	722,798
Exide Frisco	51,281	2,051,220	1,538,415	2,338,391	4,389,611	414,348	259,992	51,281	311,273	725,621	300,000	611,273	1,025,621
Exide Reading	65,816	2,632,620	1,974,465	3,001,187	5,633,807	531,792	333,685	65,816	399,500	931,292	300,000	699,500	1,231,292
Doe Run	141,590	5,663,584	4,247,688	6,456,486	12,120,070	1,144,049	717,859	141,590	859,449	2,003,498	300,000	1,159,449	2,303,498
EnviroFocus	20,139				-						300,000	300,000	300,000
Sanders	111,183	4,447,336	3,335,502	5,069,963	9,517,299	898,366	563,700	111,183	674,883	1,573,249	300,000	974,883	1,873,249
Total listed facilities		18,649,459		21,260,383	39,909,842					6,597,262	2,100,000	4,930,055	8,697,262
Total Level 1 facilities					27,328,729					4,517,552	900,000	2,837,913	5,417,552
Total Level 2 facilities					12,581,114					2,079,710	900,000	1,792,142	2,979,710
Level 3 facilities											900000	900,000	900,000
Total All Facilities					39,909,842	3,767,207	2,363,819	466,236	2,830,055	6,597,262	3,000,000	5,830,055	9,597,262

Assumptions:

Unenclosed or partially enclosed facilities would need to enclose area and vent to baghouse

Unenclosed or partially enclosed facilities would reduce their facility footprint to the size of an enclosed facility with similar production.

Using the reduced footprint methodology, the capital cost of building and baghouse was reduced by up to 40%

Buildings are 30 ft tall

Baghouse cost estimated from data submitted by facilities in survey. EPA cost manual data was significantly higher

Baghouse operating data was submitted in the survey for the control device used to estimate capital cost

Baghouse operating data verified against cost to replace bags on a bi-annual basis, costs were similar

Building O&M cost was estimated at \$1 / ft sq ft. This cost was estimated using the Air Compliance Advisor program for Permanent Total Enclosures

Building cost was estimated at \$40 /ft2. this cost was estimated using two model facilities in the Air Compliance Advisor for Permanent Total Enclosures.

The higher cost estimate of the two facilities in \$/ft2 was used to estimate all facilities

Not enough facility specific information on cost to retrofit was available for an alternate retrofit cost

Cost data for a building was submitted by Quemetco, CA in January 2011. This cost was not considered in the analysis as the cost was very high compared to other estimates

No capital cost was estimated for Envirofocus as this facility is currently undergoing an expansion and upgrade. Practices described will meet control level required.

Level 2 definition - total facility enclosures vented to baghouse

Level 3 definition - Level 2 plus additional work practices equivalent to South Coast California rule

Option 1F &2F

Facility	Total Enclosed Area Needed ft2	Building Capital Cost	New CF to be ventilated	Baghouse Capital (\$)	Total Capital cost	Annualized Capital cost Baghouse + building	Baghouse Annual Operating cost(\$)	Enclosure Annual operating cost	Enclosure and baghouse operating cost	Enclosure and baghouse total Annual cost	Work practice estimate	Annual Operation and Maintenance cost (total)	Ambient Monitoring Cost	Total Annual cost
Exide Baton Rouge	66,488	2,659,514	1,994,636	3,031,846	5,691,360	537,224	337,093	66,488	403,581	940,805	300,000	703,581	23,128	1,240,805
Exide Forest City	29,880	1,195,185	896,389	1,362,511	2,557,696	241,428	151,490	29,880	181,369	422,798	300,000	481,369	23,128	722,798
Exide Frisco	51,281	2,051,220	1,538,415	2,338,391	4,389,611	414,348	259,992	51,281	311,273	725,621	300,000	611,273	23,128	1,025,621
Exide Reading	65,816	2,632,620	1,974,465	3,001,187	5,633,807	531,792	333,685	65,816	399,500	931,292	300,000	699,500	23,128	1,231,292
Doe Run	141,590	5,663,584	4,247,688	6,456,486	12,120,070	1,144,049	717,859	141,590	859,449	2,003,498	300,000	1,159,449	23,128	2,303,498
EnviroFocus	20,139				-						300,000	300,000	23,128	300,000
Sanders	111,183	4,447,336	3,335,502	5,069,963	9,517,299	898,366	563,700	111,183	674,883	1,573,249	300,000	974,883	23,128	1,873,249
Total listed facilities		18,649,459		21,260,383	39,909,842					6,597,262	2,100,000	4,930,055	161,896	8,697,262
Total Level 1 facilities					27,328,729					4,517,552	900,000	2,837,913	69,384	5,417,552
Total Level 2 facilities					12,581,114					2,079,710	900,000	1,792,142	69,384	2,979,710
Level 3 facilities											900000	900,000	161,896	900,000
Total All Facilities					39,909,842	3,767,207	2,363,819	466,236	2,830,055	6,597,262	3,000,000	5,830,055	323,792	9,597,262

Assumptions:

Unenclosed or partially enclosed facilities would need to enclose area and vent to baghouse

Unenclosed or partially enclosed facilities would reduce their facility footprint to the size of an enclosed facility with similar production.

Using the reduced footprint methodology, the capital cost of building and baghouse was reduced by up to 40%

Buildings are 30 ft tall

Baghouse cost estimated from data submitted by facilities in survey. EPA cost manual data was significantly higher

Baghouse operating data was submitted in the survey for the control device used to estimate capital cost

Baghouse operating data verified against cost to replace bags on a bi-annual basis, costs were similar

Building O&M cost was estimated at \$1 / ft sq ft. This cost was estimated using the Air Compliance Advisor program for Permanent Total Enclosures

Building cost was estimated at \$40 /ft2. this cost was estimated using two model facilities in the Air Compliance Advisor for Permanent Total Enclosures.

The higher cost estimate of the two facilities in \$/ft2 was used to estimate all facilities

Not enough facility specific information on cost to retrofit was available for an alternate retrofit cost

Cost data for a building was submitted by Quemetco, CA in January 2011. This cost was not considered in the analysis as the cost was very high compared to other estimates

No capital cost was estimated for Envirofocus as this facility is currently undergoing an expansion and upgrade. Practices described will meet control level required.

Level 2 definition - total facility enclosures vented to baghouse

Level 3 definition - Level 2 plus additional work practices equivalent to South Coast California rule

Secondary Lead Control Cost
Control of THC / Dioxin-Furan

Incremental Improvement with increase in afterburner temperature

Facility	Furnace Type	Blast Furnace Flow rate requiring control (scfm)	Existing Afterburner Operating Temp (deg F) - if no AB, Furnace Temp	Existing AB residence time	Temp increase required (deg F)	Fuel cost
Doe Run	Mixed	10,000	500	-	-	-
East penn	Co-located					
EnviroFocus	Blast					
Exide Baton Rouge	Reverb					
Exide Baton Rouge	Blast	21,505	700	3	100	\$ 78,966.36
Exide Forest City	Blast					
Exide Frisco	Mixed	24,000	1,525	1	75	\$ 66,096.00
Exide Muncie	Co-located					
Exide Reading	Co-located					
Exide Vernon	Mixed					
Gopher Eagan	Co-located					
Quemetco (CA)	Reverb					
Quemetco (IN)	Reverb					
RSR	Reverb					
RSR	Rotary					
Sanders	Blast	16,000	1,300	3	100	\$ 58,752.00
Sanders	Blast	16,000	1,300	3	100	\$ 58,752.00

\$ 262,566

Assumptions

A 10% reduction in D/F and organics is possible with improved operating practices and increase in afterburner temperature of 100 deg F

Beyond the floor MACT for Blast furnaces would require 1600 degree afterburner to achieve control of dioxins

\$/MM BTU Nat Gas

4

Assumed the existing afterburner would remain in place. Additional afterburner fuel cost to increase temperature 100 deg F

Secondary Lead Control Cost
Control of THC / Dioxin-Furan

Beyond the floor option for controlling Blast Furnaces

Facility	Furnace Type	Blast Furnace Flow rate requiring control (scfm)	Existing Afterburner Operating Temp (deg F) - if no AB, Furnace Temp	Existing AB residence time	New AB required (Y/N)	AB Installed cost	Temp increase required (deg F)	Fuel cost	Electricity (KWH)	Electricity \$/yr	Annual Capital Cost	O&M cost	Indirect Operating cost	Total Annual O&M	Annual cost - total
Doe Run	Mixed	10000	500	0	Yes	1,040,310	1100	403,920	839,800	57,526	98,198	13,688	49,825	524,959	623,157
East penn	Co-located				No										
EnviroFocus	Blast				No										
Exide Baton Rouge	Reverb				No										
Exide Baton Rouge	Blast	21505	700	3	Yes	1,259,788	900	710,697	1,805,990	123,710	118,915	13,688	58,604	906,699	1,025,614
Exide Forest City	Blast				No										
Exide Frisco	Mixed	24000	1525	1	Yes	1,294,838	75	66,096	2,015,520	138,063	122,224	13,688	60,006	277,853	400,076
Exide Muncie	Co-located				No										
Exide Reading	Co-located				No										
Exide Vernon	Mixed				No										
Gopher Eagan	Co-located				No										
Quemetco (CA)	Reverb				No										
Quemetco (IN)	Reverb				No										
RSR	Reverb				No										
RSR	Rotary				No										
Sanders	Blast	16000	1300	2.5	Yes	1,170,019	300	176,256	1,343,680	92,042	110,441	13,688	55,013	336,999	447,440
Sanders	Blast	16000	1300	2.5	Yes	1,170,019	300	176,256	1,343,680	92,042	110,441	13,688	55,013	336,999	447,440
						5,934,974		1,533,225		503,384	560,220	68,438	278,461	2,383,508	2,943,728

Assumptions

Beyond the floor MACT for Blast furnaces would require 1600 degree afterburner to achieve control of co-located furnaces

\$/KWH 0.0685

\$/MM BTU Nat Gas 4

Labor cost / hr 25

Electricity KWH calculated from equation in <http://www.epa.gov/ttn/catc/dir1/cs3-2ch2.pdf>

corrected for density of air at 600 deg F

Assumed the existing afterburner would remain in place. Additional afterburner fuel cost to increase temperature to 1600 deg F

Used afterburner cost data submitted in Section 114 survey for three afterburner installations to estimate base capital cost. Used highest of 3 total installed cost

Derived new equation to account for flow rate - modeled after equation 2.32 in EPA cost estimation manual for Incinerators

Operating cost approach developed from EPA cost manual for incinerators.

Used afterburner operating cost data submitted in Section 114 survey as a reference. Cost is similar to that calculated in this sheet.

Cost estimated using Air Compliance Advisor (EPA cost manual program), values significantly higher than these costs. Elected to use industry supplied data as the base

Summary of WESP Control Cost by Facility

Facility	WESP ACFM	Capital cost Estimate	Annualized Capital cost	Operating Cost	Total Annualized Cost
Doe Run	446,428	46,623,434	4,400,922	2,331,172	6,732,094
East penn	167,436	25,885,878	2,443,444	1,294,294	3,737,738
EnviroFocus	79,986	16,617,415	1,568,566	830,871	2,399,437
Exide Baton Rouge	203,901	29,134,304	2,750,072	1,456,715	4,206,787
Exide Forest City	95,362	18,466,254	1,743,084	923,313	2,666,396
Exide Frisco	253,113	33,169,760	3,130,991	1,658,488	4,789,479
Exide Muncie	224,391	30,857,250	2,912,706	1,542,862	4,455,569
Exide Reading	286,727	35,746,589	3,374,225	1,787,329	5,161,555
Exide Vernon	251,490	33,041,957	3,118,927	1,652,098	4,771,025
Gopher Eagan	325,023	38,539,167	3,637,825	1,926,958	5,564,783
Quemetco (CA)	94,556	18,000,000			
Quemetco (IN)	115,468	20,712,408	1,955,105	1,035,620	2,990,725
RSR	145,133	23,758,174	2,242,604	1,187,909	3,430,512
Sanders	245,173	32,541,498	3,071,687	1,627,075	4,698,762
Total		403,094,087	36,350,158	19,254,704	55,604,862

	WESP ACFM	Furnace Only ACFM
Doe Run	446,428	266,855
East Penn	167,436	42,601
EnviroFocus	79,986	35,550
Exide Baton Rouge	203,901	126,340
Exide Forest City	95,362	95,362
Exide Frisco	253,113	52,001
Exide Muncie	224,391	26,497
Exide Reading	286,727	88,779
Exide Vernon	251,490	127,105
Gopher Eagan	325,023	106,060
Quemetco CA	94,556	94,556
Quemetco IN	115,468	48,692
RSR	145,133	113,211
Sanders	245,173	191,322
	2,934,187	1,414,930

**Activated Carbon
Injection Model Costs**

Facility/Unit ID	Annual operating hr/yr	Exhaust gas flow rate (Q) dscfm	Operating labor rate \$/hr	Activated carbon cost (ACC) \$/lb	Dust disposal cost (DDC) \$/ton	Capital recovery factor, 20-yr equipment life, 7% interest (CRF)	Cost index 2008	Cost index 1990	ACI Adjustment Factor (AF) for HG control	ACI Adjustment Factor (AF) for D/F control	Capital Investment Total \$	Unit cost \$/dscfm
Facility name						$= [i \times (1 + i)^a] / [(1 + i)^a - 1]$, where i = interest rate, a = equipment life					$= 4,500 \times (Q/1,976)^{0.6} \times (1.2 \text{ retrofit factor}) \times (575.4/361.3)$	$= \$ / Q$
Doe Run	8500	266855	\$51.26	\$1.38	\$42.14	0.09439	575.4	361.3	1.00		\$163,226	\$0.61
East Penn	8500	42601	\$51.26	\$1.38	\$42.14	0.09439	575.4	361.3	1.00		\$54,284	\$1.27
EnviroFocus	8500	35550	\$51.26	\$1.38	\$42.14	0.09439	575.4	361.3	1.00		\$48,700	\$1.37
Exide Baton Rouge	8500	126340	\$51.26	\$1.38	\$42.14	0.09439	575.4	361.3	1.00		\$104,219	\$0.82
Exide Forest City	8500	95362	\$51.26	\$1.38	\$42.14	0.09439	575.4	361.3	1.00		\$88,034	\$0.92
Exide Frisco	8500	52001	\$51.26	\$1.38	\$42.14	0.09439	575.4	361.3	1.00		\$61,183	\$1.18
Exide Muncie	8500	26497	\$51.26	\$1.38	\$42.14	0.09439	575.4	361.3	1.00		\$40,826	\$1.54
Exide Reading	8500	88779	\$51.26	\$1.38	\$42.14	0.09439	575.4	361.3	1.00		\$84,335	\$0.95
Exide Vernon	8500	127105	\$51.26	\$1.38	\$42.14	0.09439	575.4	361.3	1.00		\$104,597	\$0.82
Gopher Eagan	8500	106060	\$51.26	\$1.38	\$42.14	0.09439	575.4	361.3	1.00		\$93,833	\$0.88
Quemetco CA	8500	94556	\$51.26	\$1.38	\$42.14	0.09439	575.4	361.3	1.00		\$87,586	\$0.93
Quemetco IN	8500	48692	\$51.26	\$1.38	\$42.14	0.09439	575.4	361.3	1.00		\$58,816	\$1.21
RSR	8500	113211	\$51.26	\$1.38	\$42.14	0.09439	575.4	361.3	1.00		\$97,579	\$0.86
Sanders	8500	191322	\$51.26	\$1.38	\$42.14	0.09439	575.4	361.3	1.00		\$133,685	\$0.70

\$1,220,904

**Activated Carbon
Injection Model Costs**

Unit-specific field

Facility/Unit ID	Direct Annual	Supervisory		Activated		Indirect Annual	Property taxes, insurance, and		Total Annual Cost	
Facility name	Operating labor	labor	Maintenance	carbon	Dust disposal	Overhead	administration	Capital recovery	Total cost	
	\$/yr	\$/yr	\$/yr	\$/yr	\$/yr	\$/yr	\$/yr	\$/yr	\$/yr	(\$/yr) / dscfm
FacilityID	= (0.25 hr/8-hr shift) x H x LR	= 0.15 x (operating labor)	= 0.2 x TCI	= 0.00127 x Q x H x ACC x AF	= 0.00127 x Q x (1 ton/2,000 lb) x H x DDC x AF	= 0.6 x (labor + maintenance materials)	= 0.04 x TCI	= CRF x TCI	= Direct Annual Costs + Indirect Annual Costs	= (\$/yr) / Q
Doe Run	\$13,616	\$2,042	\$32,645	3975365.621	60696.34321	\$28,982	\$6,529	\$15,407	\$4,135,284	\$15.50
East Penn	\$13,616	\$2,042	\$10,857	634631.3571	9689.625141	\$15,909	\$2,171	\$5,124	\$694,041	\$16.29
EnviroFocus	\$13,616	\$2,042	\$9,740	529596.8707	8085.946424	\$15,239	\$1,948	\$4,597	\$584,865	\$16.45
Exide Baton Rouge	\$13,616	\$2,042	\$20,844	1882095.145	28736.04689	\$21,901	\$4,169	\$9,838	\$1,983,241	\$15.70
Exide Forest City	\$13,616	\$2,042	\$17,607	1420617.25	21690.14889	\$19,959	\$3,521	\$8,310	\$1,507,363	\$15.81
Exide Frisco	\$13,616	\$2,042	\$12,237	774664.0971	11827.66125	\$16,737	\$2,447	\$5,775	\$839,346	\$16.14
Exide Muncie	\$13,616	\$2,042	\$8,165	394725.0397	6026.707672	\$14,294	\$1,633	\$3,854	\$444,356	\$16.77
Exide Reading	\$13,616	\$2,042	\$16,867	1322542.192	20192.72753	\$19,515	\$3,373	\$7,961	\$1,406,110	\$15.84
Exide Vernon	\$13,616	\$2,042	\$20,919	1893496.889	28910.13003	\$21,947	\$4,184	\$9,873	\$1,994,989	\$15.70
Gopher Eagan	\$13,616	\$2,042	\$18,767	1579986.426	24123.41594	\$20,655	\$3,753	\$8,857	\$1,671,800	\$15.76
Quemetco CA	\$13,616	\$2,042	\$17,517	1408610.188	21506.82366	\$19,905	\$3,503	\$8,268	\$1,494,969	\$15.81
Quemetco IN	\$13,616	\$2,042	\$11,763	725369.5932	11075.02705	\$16,453	\$2,353	\$5,552	\$788,224	\$16.19
RSR	\$13,616	\$2,042	\$19,516	1686515.588	25749.91554	\$21,104	\$3,903	\$9,211	\$1,781,658	\$15.74
Sanders	\$13,616	\$2,042	\$26,737	2850138.001	43516.23744	\$25,437	\$5,347	\$12,619	\$2,979,453	\$15.57

\$22,305,698

AmbMonitoring Cost

	Cost	Annual cost per monitor	Number of monitors / site	Total Annual cost	Total cost- 14 facilities
Ambient Lead Monitoring (lab analysis) per test	127	7725.8	2	15452	216,323
Ambient Monitoring Equipment Annual Lease	2500	2500	2	5000	70,000
Labor to collect and ship samples, analyze data	22	1338.3	2	2677	37,473
Total monitoring cost				23,128	323,797

Ambient monitors tested once every 6 days

References:

Table 3.5 - Additional Testing and Monitoring Costs, Primary Lead Smelting Technical Support document

Appendix D
BUSCH FEF-50 Quote



10431 PERRY HIGHWAY, WEXFORD, PA 15090
PHONE 724-940-2326 FAX 724-940-4140

TO: ENVIRON INTERNATIONAL CORPORATION
ATTN: RUSSELL KEMP

FROM: LOIS MCELWEE, X 208

SUBJECT: PRELIMINARY PROPOSAL V-6750

DATE: MAY 6, 2011

Russell,

Per your request, we are pleased to furnish budget pricing for Carbon Steel construction, as follows:

One (1) FEF Model FEF-50 air filtration units 50,000 CFM with the following:

- ◆ Fully-welded unit housing with full structural base and open grating in filter section. Grating is Carbon Steel.
- ◆ Pyramidal hopper shipped loose
- ◆ HEPA header sealing system with stainless steel frames and HEPA filter bolt lock type.
- ◆ High capacity absolute 2000 cfm; 99.97% DOP HEPA filters with neoprene gasketing downstream. HEPA filters will be shipped loose for installation by others.
- ◆ Pre-piped pulse system with header, pulse pipes and pulse valves with solenoids. Header and pipes of carbon steel with industrial enamel finish.
- ◆ Primary filtration section includes filter cages, Galvanized Steel 11 gauge wire and pulse filter media installed. Thimbles are 360 degree seal welded.
- ◆ Dirty side – back wall, side walls, roof, tube sheet, doors and inlet collar constructed of Carbon Steel. Floor grating is Carbon Steel.
- ◆ Clean side – two (2) compartments side walls, roof, doors and floor constructed of Carbon Steel.



10431 PERRY HIGHWAY, WEXFORD, PA 15090
PHONE 724-940-2326 FAX 724-940-4140

- ◆ Fan - Backward Inclined belt driven 50,000 CFM with 125 HP motor
- ◆ Outlet Volume Control Damper; manual control
- ◆ Shipped complete with fan and motor wired and installed

Walls and roof are minimum 10 Gauge material and Tube Sheet and floor are minimum 7 Gauge material. Structural base is carbon steel with standard finish. Sandblast epoxy available at additional cost and is recommended for outdoor locations.

Approximate Unit dimensions: 31' long x 11'6" wide x 12' high; hopper top flange is approximately 17' long x 10' wide. T.O.P. is bottom of hopper flange suited for a 9" screw conveyor by others. T.O.P. is flange of fan outlet damper and inlet flange on top of unit.

Total net budgetary price for (1) FEF-50 unit..... \$ 298,000

FOB Factory; freight collect; shipment 22-24 weeks after drawing approval.

Allow 6-8 weeks for drawings.

Pricing is firm for 30 days

Terms net 30 days – progress payments: 20% down payment, 20% completion of sub vendor order placement, 20% issue of shop orders for fabrication, and 40% shipment. Terms and conditions attached.

Lois McElwee

BUSCH INTERNATIONAL

FEF SERIES

Fugitive Emission Filtration Units



A CECO Environmental Company

10431 Perry Highway • Wexford, PA 15090
 Phone: 724.940.2326 • Fax: 724.940.4140
 busch@cecoenviro.com

Provides Secondary Emissions Control of Metallurgical Fumes

Busch International FEF SERIES industrial grade, fugitive emission filtration units use high efficiency self-cleaning fabric filtration tubes. The equipment removes heat and fugitive dusts from metallurgical melting process applications. The modules are factory assembled with filtration system, pulse cleaning, fabric tubes, controls, and main air blower on a common structural base.

Significant cost savings over field assembled systems are realized because the FEF SERIES units are shipped pre-assembled, wired and factory tested. Minimum field labor is required for unit installation. Only connection to main power and compressed air source is necessary to initiate operation. Multiple modules are arranged for a built-up system with air volume capacity as required to satisfy the project requirements.

The FEF SERIES units come in standard sizes available for simple installation. Unit arrangement and dimensions, location, connections, materials of construction and wiring can be modified to meet individual user specifications. Project costs are often lower when compared to built up systems consisting of baghouse modules, interconnecting duct and separate fans. Construction features include a structural base, steel plate floor, heavy gauge welded housing panels and heavy duty door hardware. Centrifugal fans are minimum Class III construction and are backwardly inclined power limiting design. Direct driven fans eliminate belt maintenance. Electrical enclosures are NEMA 12 or NEMA 4 with wiring in rigid or flexible conduit. Optional electrical enclosures are available to suit plant standards.

FEF SERIES units are designed to store dust within the base of the compartment or storage hopper below.



Collection of secondary lead oxide emissions using four FEF SERIES units.

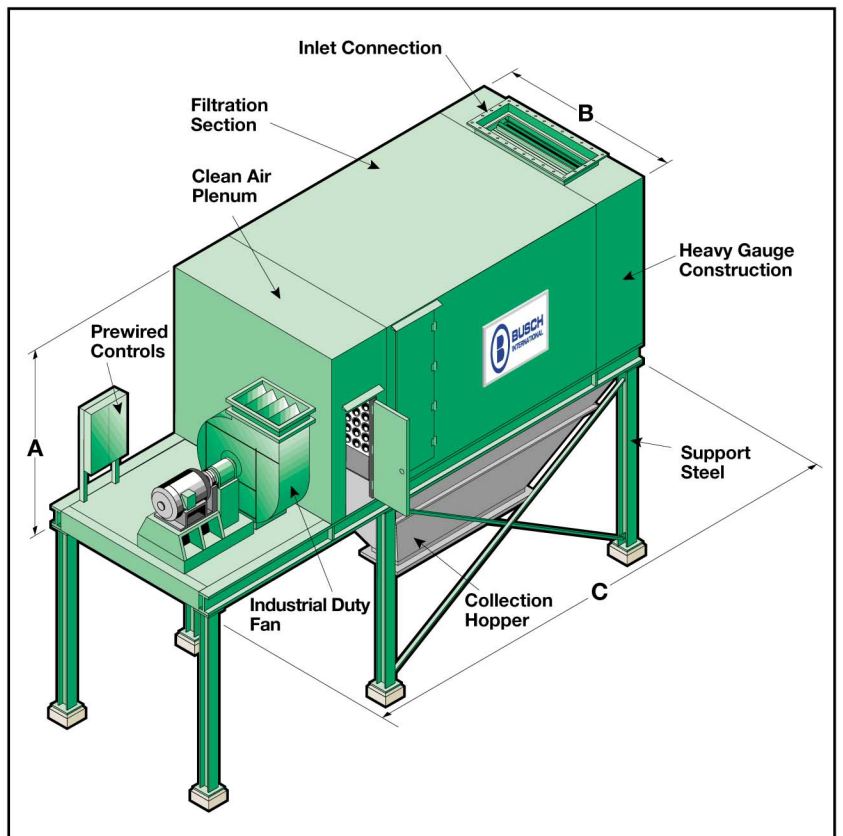

A typical FEF Series unit arrangement.

Accessories and Options

- Alternate paint systems
- Hoppers for dust storage
- Gas adsorption
- Sound attenuator
- Variable speed drives
- HEPA safety filters
- Dampers
- Screw conveyor
- Stainless steel construction
- Support steel and platforms

Dimensional Data

MODEL NO.	CAPACITY SCFM	DIMENSIONS		
		A	B	C
FEF-10	10,000	5'-6"	5'-0"	18'-0"
FEF-20	20,000	7'-6"	7'-0"	20'-6"
FEF-30	30,000	9'-6"	7'-6"	24'-0"
FEF-40	40,000	10'-0"	10'-0"	26'-0"
FEF-50	50,000	11'-0"	12'-0"	30'-0"

Dimensions and sizes are for reference only.

Appendix E
EPA's Draft Summary of the Technology
Review for the Secondary Lead Smelting
Source Category

MEMORANDUM

To: Chuck French, U.S. Environmental Protection Agency, OAQPS

From: Mike Burr, Donna Lazzari, and Danny Greene, ERG

Date: April 2011

Subject: Draft Summary of the Technology Review for the Secondary Lead Smelting Source Category

This memorandum summarizes the results of an analysis to identify developments in practices, processes, and control technologies for emissions sources of hazardous air pollutants (HAP) from the Secondary Lead Smelting source category. This analysis is part of EPA's review efforts in accordance with section 112(d)(6) of the Clean Air Act (CAA). This memorandum is organized as follows:

- 1.0 Background
 - 1.1 Requirements of Section 112(d)(6) of the CAA
 - 1.2 Description of the Secondary Lead Smelting Source Category and Requirements of the Current NESHAP
- 2.0 Developments in Practices, Processes and Control Technologies
 - 2.1 Stack Emissions
 - 2.2 Fugitive Emissions
- 3.0 Recommended Revisions Based on Developments in Practices, Processes and Control Technologies
 - 3.1 Stack Emissions
 - 3.2 Fugitive Emissions
- 4.0 Conclusions

1.0 BACKGROUND

1.1 Requirements of Section 112(d)(6) of the CAA

Section 112 of the CAA requires EPA to establish technology-based standards for sources of HAP. These technology-based standards are often referred to as maximum achievable control technology, or MACT, standards. Section 112 also contains provisions requiring EPA to periodically revisit these standards. Specifically, paragraph 112(d)(6) states:

(6) REVIEW AND REVISION. – The Administrator shall review, and revise as necessary (taking into account developments in practices, processes, and control technologies), emissions standards promulgated under this section no less often than every 8 years.

1.2 Description of the Secondary Lead Smelting Source Category and Requirements of the Current NESHAP

The current National Emissions Standards for Hazardous Air Pollutants (NESHAP) for the Secondary Lead Smelting source category was promulgated on June 13, 1997 (62 FR 32216) and codified at 40 CFR part 63, subpart X. As promulgated in 1997, the NESHAP applies to affected sources of HAP emissions at secondary lead smelters. The current NESHAP (40 CFR 63.542) defines “secondary lead smelters” as “any facility at which lead-bearing scrap material, primarily, but not limited to, lead-acid batteries, is recycled into elemental lead or lead alloys by smelting.” The secondary lead smelting process consists of: (1) pre-processing of lead bearing materials, (2) melting lead metal and reducing lead compounds to lead metal in the smelting furnace, and (3) refining and alloying the lead to customer specifications. The NESHAP for the Secondary Lead Smelting source category does not apply to primary lead smelters, lead remelters, or lead refiners.

Today, there are 14 secondary lead smelting facilities that are subject to the NESHAP. No new secondary lead smelters have been built in the last 20 years, and no new secondary lead smelting facilities are anticipated in the foreseeable future, although one facility is currently in the process of expanding their operations.

HAP are emitted from secondary lead smelting as stack releases (i.e., process emissions, and process fugitive emissions) and fugitive dust emissions. Process emissions include exhaust gases from feed dryers and from blast, reverberatory, rotary, and electric furnaces. The HAP in process emissions are comprised primarily of metals (mostly lead compounds, but also some arsenic, cadmium, and other metals) and also may include organic compounds that result from incomplete combustion of coke that is charged to the smelting furnaces as a fuel or fluxing agent, combustion of natural gas or other fuels, or combustion of small amounts of plastics or other materials that get fed into the furnaces along with the lead-bearing materials. Process fugitive emissions are released from various sources throughout the smelting process, including smelting furnace charging and tapping points, refining kettles, agglomerating furnace product taps, and drying kiln transition equipment. Process fugitive emissions are comprised primarily of metal HAP. Fugitive dust emissions are emissions that are not associated with a specific process or process fugitive vent or stack. Process fugitive emissions are comprised of metal HAP and result

from the entrainment of HAP in ambient air due to material handling activities, vehicle traffic, wind, and other activities.

The current NESHAP applies to process emissions from blast, reverberatory, rotary, and electric smelting furnaces, agglomerating furnaces, and dryers; process fugitive emissions from smelting furnace charging points, smelting furnace lead and slag taps, refining kettles, agglomerating furnace product taps, and dryer transition equipment; and fugitive dust emissions from roadways, battery breaking areas, furnace charging and tapping areas, refining and casting areas, and material storage areas. For process sources, the current NESHAP specifies numerical emissions limits for total hydrocarbons (THC) and lead compounds for blast furnaces and collocated blast and reverberatory furnaces. Additionally, emissions limits for lead are specified for reverberatory, electric, and rotary furnaces. Lead compound emissions from all smelting furnace configurations are limited to an outlet concentration of 2.0 milligrams per dry standard cubic meter (mg/dscm) (0.00087 grains per dry standard cubic foot (gr/dscf)) (40 CFR 63.543(a)). THC emissions from collocated blast and reverberatory furnaces are limited to an outlet concentration of 20 parts per million volume (ppmv) (expressed as propane) corrected to 4 percent carbon dioxide (CO₂). THC emissions are limited to 360 ppmv (as propane) at 4 percent CO₂ from existing blast furnaces and 70 ppmv (as propane) at 4 percent CO₂ from new blast furnaces (40 CFR 63.543(c)). The current NESHAP does not specify limits for THC emissions from reverberatory furnaces not collocated with blast furnaces, rotary furnaces, or electric furnaces.

The current NESHAP requires that process fugitive emissions sources be equipped with an enclosure hood meeting minimum face velocity requirements or be located in a total enclosure subject to general ventilation that maintains the building at negative pressure (40 CFR 63.543(b)). Ventilation air from the enclosure hoods and total enclosures are required to be conveyed to a control device. Lead emissions from these control devices are limited to 2.0 mg/dscm (0.00087 gr/dscf) (40 CFR 63.544(c)). Lead emissions from all dryer emissions vents and agglomerating furnace vents are limited to 2.0 mg/dscm (0.00087 gr/dscf) (40 CFR 63.544(d)). The current NESHAP also requires the use of bag leak detection systems for continuous monitoring of baghouses in cases where a high efficiency particulate air (HEPA) filter are not used in series with a baghouse (40 CFR 63.548(c)(9)).

For fugitive dust sources, the current NESHAP requires that facilities develop and operate according to a standard operating procedures (SOP) manual that describes, in detail, the measures used to control fugitive dust emissions from plant roadways, battery breaking areas, furnace areas, refining and casting areas, and material storage and handling areas.

2.0 DEVELOPMENTS IN PRACTICES, PROCESSES, AND CONTROL TECHNOLOGIES

For the purposes of this technology review, a “development” was considered to be a (n):

- add-on control technology or other equipment that was not identified during the development of the current NESHAP for the source category;
- improvement in add-on control technology or other equipment that was identified and considered during development of the current NESHAP for the source category that could result in significant additional HAP emissions reductions;
- work practice or operational procedure that was not identified during development of the current NESHAP for the source category; or
- applicable process change or pollution prevention alternative that was not identified and considered during the development of the current NESHAP for the source category.

We investigated developments in practices, processes, and control technologies for three categories of HAP emissions sources from secondary lead smelters: (1) stack emissions of lead and other metal HAP, (2) stack emissions of organic HAP, and (3) fugitive emissions of lead and other metal HAP. To identify developments, we conducted searches of EPA’s RACT/BACT/LAER (Reasonably Achievable Control Technology/Best Available Control Technology/Lowest Achievable Emissions Rate) clearinghouse and the Internet for information on secondary lead smelting and similar processes, examined the Section 114 information collection request (ICR) responses from the 14 secondary lead smelting facilities, reviewed technologies employed by similar industries, and reviewed new or updated NESHAPs for other source categories. The results of these analyses are presented in the following sections.

2.1 Stack Emissions

The current NESHAP specifies emissions limits for metal HAP (using lead as a surrogate) and organic compounds (using THC as a surrogate) from stacks. This section of the technology review will focus on developments in practices, processes, and control technologies applicable to emissions of metal HAP and organic compounds from stacks.

a. Metal Hap Emissions from Stacks

Based on a review of the ICR responses, the most common control technology employed by the industry to control emissions of metal HAP from stacks is fabric filtration (or baghouses). Several types of baghouses are currently used by the industry, including shaker, pulse jet, and reverse pulse jet bag filters. One facility uses a wet electrostatic precipitator (WESP) downstream of a baghouse to further reduce emissions of metal HAP from stacks. Two other facilities have plans to install similar WESP units. Several facilities also reported using HEPA filters as an add-on control downstream of their baghouses. Additionally, some facilities reported using cartridge collectors; however these types of controls are generally suited to reduce

metal HAP emissions from sources that have lower inlet concentrations and are typically not used to control metal HAP in smelting furnace exhaust.

The first part of our analysis included attempting to determine which control technology (e.g., fabric filter, WESP, HEPA filter, cartridge collectors) achieves the greatest control efficiency for metal HAP. We could not directly calculate control efficiencies due to lack of inlet concentration data; however, we compared the outlet lead concentrations from the different control technologies based on emissions data that we received in the ICR.

As displayed in Figure 2-1, the average stack outlet lead concentration from the baghouse and WESP combination was almost 50 times lower than the outlet concentration achieved by using baghouses alone. HEPA filters used downstream of a baghouse achieved approximately 20 percent lower outlet lead concentrations than baghouses alone. Cartridge collectors appear to achieve outlet lead concentrations approximately three times lower than baghouses; however, as mentioned, cartridge collectors are generally limited to emissions points with lower flow rates and inlet loading concentrations.

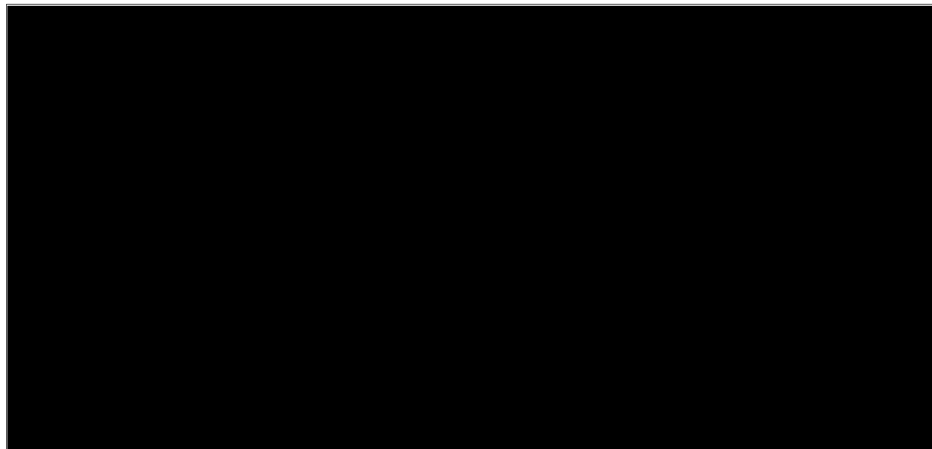

Figure 2-1. Comparison of Control Device Outlet Lead Concentrations from Different Technologies.

Based on emissions data received in the ICR, we also compared the relative performance of each baghouse across facilities and attempted to determine the factors that correlate best with low outlet lead concentrations. The factors that we considered include baghouse type (e.g., shaker, pulse jet, reverse bag pulse), filter material, and age of the unit. Figure 2-2 shows the results of these analyses. Based on our analysis, the most significant factor affecting baghouse performance is the age of the unit. We found that units installed prior to 1989 generally had significantly higher outlet lead concentrations than the newer units. Shaker baghouses appear to have higher outlet lead concentrations than those of the pulse jet or reverse bag pulse type.

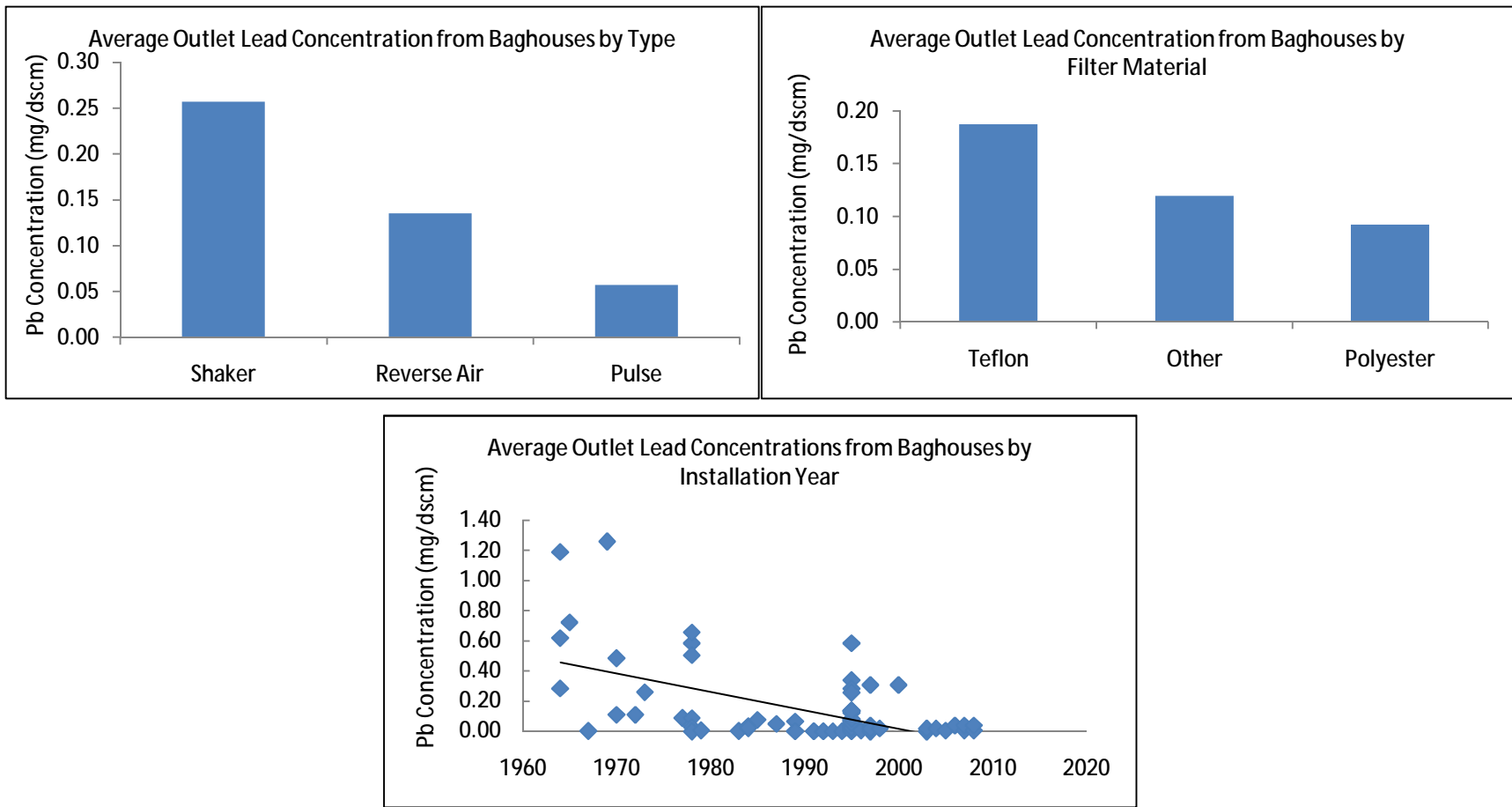

Figure 2-2. Comparison of Baghouse Outlet Lead Concentrations Based on Type (Upper Left), Filter Media (Upper Right), and Installation Year (Bottom).

However, the majority of the older units appear to be shaker types, and thus the age of the baghouse may be the controlling factor. We did not find a significant correlation between the outlet lead concentration and the filtration media used in the baghouses, although one company in the industry suggested, based on its experience, that Teflon (polytetrafluoroethylene) bags specifically supplied by Gore-Tex® performed better than other bag types. The company also suggested that the most critical factors influencing baghouse performance are proper installation and maintenance practices. They mentioned specific practices such as ensuring proper installation of the bags and properly sealing all ducts and dust conveyance devices. Additionally, they claim that replacing torn bags, rather than repairing them, can significantly improve baghouse performance.

Based on our analyses, we believe that the most important development in the control of stack emissions of metal HAP from this source category has been improvement in the performance of baghouses throughout the industry. The biggest indicator of such improvements is the level of metal HAP emissions currently being achieved in the industry in relation to the allowable level in the current NESHAP (referred to as “MACT-allowable”), which is a lead based concentration standard of 2.0 mg/dscm for all stacks. Figure 2-3 shows the lead concentrations reported by the industry in the ICR compared to the lead concentration limit in the current NESHAP. As illustrated by Figure 2-3, the outlet lead concentrations currently being achieved by the industry are far below, and in most cases orders of magnitude below, the concentration limit specified in the current NESHAP. The average reported stack lead concentration was 0.16 mg/dscm with a median of 0.04 mg/dscm. This large discrepancy between actual and MACT-allowable stack lead concentrations is likely a result of improvements in practices, processes, and control technologies that have significantly improved the performance of baghouses employed by this industry since the promulgation of the current NESHAP. We also believe that the concentration data presented in Figure 2-3 clearly show that improvements in baghouse technology and operation have occurred that resulted in the capability of achieving significantly lower stack lead emissions than what is required by the current NESHAP.

b. Organic HAP and Dioxin and Furan Emissions

Based on our review of the ICR responses, we found that emissions of organic HAP from smelting furnaces vary substantially among the different furnace types. In general, emissions of organic HAP from blast furnaces are much higher than those from other furnace types. Information collected in the ICR indicates that this is likely due to the much lower exit temperature of the blast furnace exhaust relative to the other furnace types. The majority of facilities that operate blast furnaces use afterburners to control emissions of organic HAP. The exhaust of reverberatory furnaces is sufficiently hot that the use of an afterburner is generally not

required to meet the current THC limit. Some facilities that operate both blast and reverberatory furnaces comingle the hotter reverberatory furnace stream with the cooler blast furnace stream to control organics in the blast furnace stream. We did not identify new control technologies or developments in the mentioned existing control technologies that would achieve reductions in organic HAP emissions beyond the limits established in the current NESHAP.

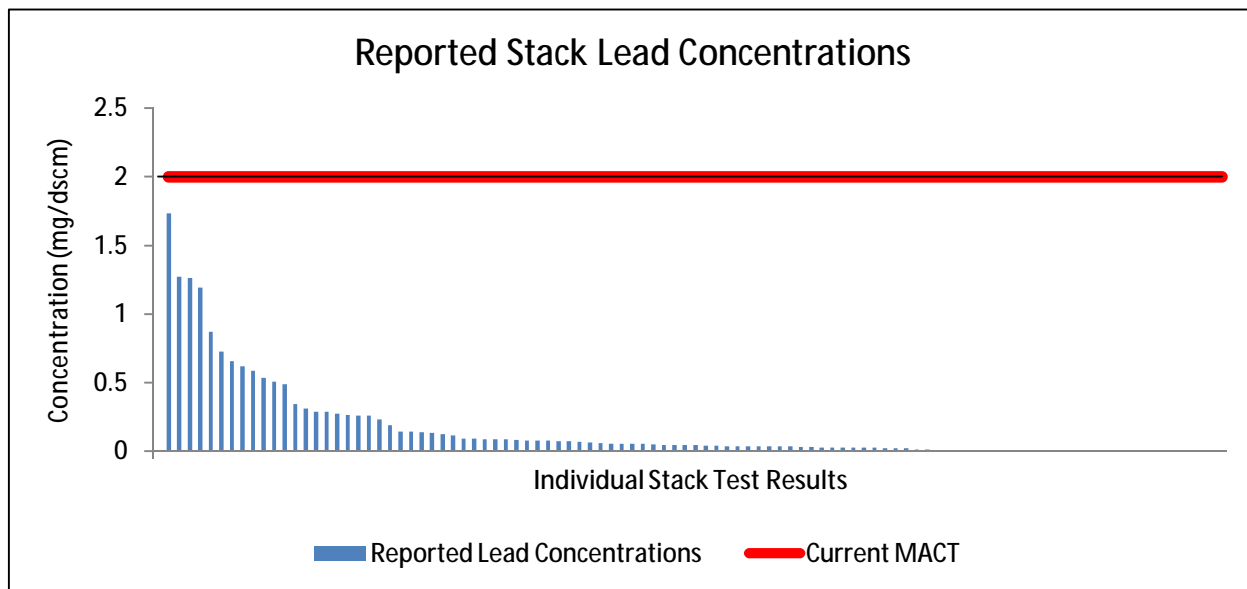

Figure 2-3. Comparison of Stack Lead Concentrations Reported by the Industry with the Current MACT Standard.

Although dioxin and furan (D/F) emissions limits are not specified in the current NESHAP, we investigated technologies available for prevention and/or control of D/F emissions from the smelting furnaces. Based on data submitted by the industry in the ICR, D/F emissions from blast furnaces are one to three orders of magnitude higher than emissions from reverberatory and electric furnaces. The key conditions typically associated with higher D/F emissions, listed in order of relative importance¹, are:

- Poor combustion conditions,
- High particulate concentration in the flue gases of a combustion process,
- Increased residence time for particulate in critical temperature window (150 - 450 degrees Celsius),
- Particulate matter containing metals that can catalyze formation to dioxin,
- Waste or fuel that is comprised of complex organic or lignin-like structure, and

¹ Gullett, Brian (EPA) and Seeker, Randy (EER Corporation), *Chlorinated Dioxin and Furan Formation Control and Monitoring*. Presentation at the Industrial Combustion Coordinated Rulemaking Meeting, September 17, 1997.

- Sufficient chlorine.

We believe the controlling factor for D/F formation in blast furnaces is the relatively low exit temperature of the exhaust stream in comparison to other furnace types.

We identified two technologies employed by this source category that have demonstrated effective control of D/F emissions from blast furnaces: (1) incineration of the furnace exhaust, and (2) comingling of the blast furnace exhaust with the hotter reverberatory furnace exhaust. Based on information submitted in the ICR and information in the literature on dioxin destruction efficiency, operating an afterburner at sufficient temperature (approximately 1,600 degrees Fahrenheit) with adequate residence time (approximately 2.0-2.5 seconds) can achieve significant reductions in D/F emissions from blast furnaces². Additionally, emissions data submitted in the ICR indicate that D/F emissions from collocated blast and reverberatory furnaces are generally lower than emissions from a blast furnace alone. Average exhaust D/F concentrations of the various furnace types are summarized in Table 2-1.

Table 2-1. Summary of Exhaust D/F Concentrations by Furnace Type.

Furnace Type	Average D/F (nanograms/dscm)
Reverberatory furnaces not collocated with blast furnaces, and reverberatory furnaces mixed with electric furnaces	0.10
Blast Furnaces	38.83
Collocated Blast and Reverberatory Furnaces	0.19
Rotary Furnaces	0.14

A review of technologies employed by other industries to control D/F emissions concluded that injecting activated carbon into the exhaust stream can also achieve significant reductions of D/F emissions; however, the costs associated with this technology for this source category were determined to be high (see Draft Cost Impacts of the Revised NESHAP for the Secondary Lead Smelting Source Category).

Because the presence of chlorine is necessary for D/F formation, we also examined the potential sources of chlorine in the feed materials charged to the smelting furnaces. Historically, the plastic battery casings used in the construction of automotive batteries contained polyvinyl chloride (PVC). Although battery casings are no longer made of PVC, the battery casings can sometimes contain small amounts of chlorinated flame retardants. This material may be introduced into the furnace through incomplete separation of the battery casing material from the

² Ficarella, Domenico and Laforgia, Domenico, *Numerical Simulation of Flow-Field and Dioxins Chemistry for Incineration Plants and Experimental Investigation*, Waste Management, 20 (2000) 27-49. <http://www.bvsde.paho.org/bvsacd/cd43/antonio.pdf>

lead-bearing material in the feed preparation process. Chlorine may also be present in the coke fed to the furnace as a fuel and reducing agent. Moreover, we believe that occasionally some older batteries that still contain PVC casings could be processed.

Based on our review, the main control of D/F emissions occurs due to measures initially implemented to control organic HAP emissions (i.e., incineration and co-mingling of furnace exhaust streams). We identified one other control technology with the potential to reduce D/F emissions (i.e., carbon injection); however, the costs to apply this technology were determined to be high.

2.2 Fugitive Emissions

As outlined in section 1.2 of this memorandum, the pollutants emitted from fugitive emissions sources in this source category are metal HAP. Therefore, we focused on identifying advancements in practices, processes, and control technologies related to fugitive emissions of metal HAP. Sources of fugitive emissions at secondary lead smelters include dust from plant roadways, battery breaking operations, material storage areas, and process fugitives that are not captured by a control device.

The minimum requirements for control of fugitive emissions in the current NESHAP for the following specified fugitive sources are:

- Plant roadways – must be cleaned twice per day;
- Battery breaking area – partial enclosure of storage piles and wet suppression with twice daily pavement cleaning;
- Furnace and refining and casting areas – partial enclosure and pavement cleaning; and
- Material Storage and Handling Areas – partial enclosure, wet suppression, and vehicle wash at exits.

Based on our analysis of information received in the ICR, we grouped the facilities into three categories that describe the level of fugitive emissions control implemented. Table 2-2 defines these categories and Table 2-2 summarizes our categorization for each facility.

Table 2-2. Enclosure Category Definitions.

Enclosure Category	Description
Level 1 Enclosure	Facilities described as having Level 1 enclosure meet the enclosure requirements in the current NESHAP. The facilities rely primarily on enclosure hoods to capture process fugitive emissions and partial enclosures with wet suppression for process units and storage areas.
Level 2 Enclosure	Facilities described as having Level 2 enclosure generally employ, in addition to enclosure hoods for process fugitive sources, a combination of negative pressure total enclosures and partial enclosures with wet suppression for process units and storage areas.

Enclosure Category	Description
Level 3 Enclosure	Facilities described as having Level 3 enclosure generally employ, in addition to enclosure hoods for process fugitive sources, negative pressure total enclosures for all process units and storage areas.

Table 2-3. Enclosure Category Assigned to the 14 Secondary Lead Smelting Facilities.

Facility	Enclosure Category
Exide Technologies – Baton Rouge, LA	Level 1
Exide Technologies – Forest City, MO	Level 2
Exide Technologies – Frisco, TX	Level 2
Exide Technologies – Muncie, IN	Level 3
Exide Technologies – Reading, PA	Level 2
Exide Technologies – Vernon, CA	Level 3
Revere Smelting And Refining – Middletown, NY	Level 3
Quemetco Inc. – Industry, CA	Level 3
Quemetco Inc. – Indianapolis, IN	Level 3
Sanders Lead Co. – Troy, AL	Level 1
EnviroFocus Technologies – Tampa, FL	Level 2
Gopher Resources – Eagan, MN	Level 3
Buick Resource Recycling Facility – Boss, MO	Level 1
East Penn Manufacturing – Lyons, PA	Level 3

As displayed in Table 2-3, our analysis concludes that 11 of the 14 facilities are controlling fugitive emissions beyond the levels required by the current NESHAP. Additionally, seven of the 14 facilities have placed all of their process areas in total enclosures under negative pressure with ventilation to a control device. Furthermore, an 8th facility (EnviroFocus Technologies) has a current project to implement level 3 enclosure. Of the seven facilities that are currently level 3 enclosures, several facilities claimed performing additional work practices (beyond the enclosures) that exceed the requirements of the current NESHAP to further limit the formation of fugitive dust in other areas of their facilities. Examples of these work practices include:

- more complete vehicle washing inside buildings;
- improved roadway cleaning techniques and frequency;
- pavement of entire facility grounds;
- cleaning of building roofs and exteriors;

- use of daily ambient monitoring to diagnose plant activities that lead to exceedances of the National Ambient Air Quality Standards (NAAQS) for lead;
- timely cleaning of accidental releases;
- inspection of outside battery storage areas for broken batteries; and
- performance of all maintenance activities inside total enclosures operated under negative pressure.

Our analysis of ambient lead concentration data measured near the facilities indicates that facilities with level 3 enclosure that implement the work practices described above are generally achieving much lower lead concentrations near their property boundaries (see Figure 3-2). For this reason, we believe that developments in practices, processes, and control technologies with regard to fugitive emissions of metal HAP have occurred that can result in reduced metal HAP emissions from fugitive sources beyond the standards contained in the current NESHAP.

3.0 RECOMMENDED REVISIONS BASED ON DEVELOPMENTS IN PRACTICES, PROCESSES, AND CONTROL TECHNOLOGIES

Based on the analyses presented above, we are recommending the following revisions to the current NESHAP with regards to stack and fugitive emissions from the Secondary Lead Smelting source category.

3.1 Stack Emissions

As described in section 2.1 of this memorandum, the concentrations of lead in stacks reported by this industry in the ICR are far below the level specified in the current NESHAP, indicating improvements in the control of metal HAP emissions since promulgation of the current NESHAP. Our analysis indicates that this is primarily a result of improved performance of baghouses. Therefore, we recommend revising the current NESHAP to reflect the level of performance currently being achieved by facilities that implement well-performing baghouses to control emissions of metal HAP from stacks.

When considering the most appropriate form of a revised lead standard for this source category, we considered alternatives to the current form (i.e., outlet lead concentration). However, our analysis indicates that a concentration-based lead standard continues to be the most appropriate form for this industry. We then attempted to determine the appropriate reduction to the current lead concentration limit of 2.0 mg/dscm. As outlined in section 2.1, the average stack concentration of lead reported by the industry in the ICR was 0.16 mg/dscm with a median concentration was 0.04 mg/dscm. Over 96 percent of the reported concentrations were less than half the current limit of 2.0 mg/dscm and over 80 percent of the reported concentrations were at least an order of magnitude less than the current limit. Our analyses conclude that advancements in the performance of baghouses appear to be the controlling factor for these lower concentrations and that reducing the current lead concentration limit from 2.0 to 0.2

mg/dscm would reflect the level of control achieved in practice by facilities that implement well-performing baghouses.

Figure 3-1 compares the lead concentrations reported by the industry in the ICR with a potential revised lead concentration limit of 0.2 mg/dscm. Although the majority of stacks reported concentrations well below 0.2 mg/dscm, a limited number of stacks would need improvements, possibly in the form of improved maintenance practices on their existing baghouses or installation of newer, more efficient units. To provide the facilities flexibility in determining the best approach to meeting a revised concentration limit, we considered proposing a facility-wide flow-weighted average lead concentration limit of 0.2 mg/dscm. For this limit, facilities would assign a weighting factor to each stack lead concentration based on the flow rate of the stack. They would then sum the flow-weighted concentration of all the stacks at their facility to get a facility-wide flow-weighted concentration. A limit in this form would reflect the level of metal HAP emissions control being achieved in practice by well performing baghouses while providing flexibility to the facilities in determining the most cost-effective approach to achieving the necessary reductions.

As required under section 112(d)(6), we considered the costs and other impacts associated with revising the lead concentration limit in the manner described above. As described in the Draft Cost Impacts of the Revised NESHAP for the Secondary Lead Smelting Source Category, we estimate that three baghouses at two facilities would need to be replaced as a result of the revised limit. The estimated total capital cost is \$7.7 million with a total annualized cost of \$1.7 million. We estimate that the revised limit would result in annual reductions of metal HAP of approximately 5.9 tons with co-reductions in emissions of particulate matter (PM) of approximately 56 tons. We do not anticipate additional energy use associated with this revised limit, as only replacement baghouses, as opposed to new additional units, are expected. Furthermore, we do not anticipate any adverse non-air environmental impacts associated with the implementation of this revised limit.

For these reasons, we are recommending that a flow-weighted average lead concentration limit of 0.2 mg/dscm be applied to the sum of all stacks at each facility in this source category. To limit the potential impacts of any individual stack, we are also recommending that a maximum lead concentration limit of 1.0 mg/dscm be applied to individual stacks in this source category. This is warranted given the fact that, as described above, over 96 percent of stack lead concentrations reported in the ICR were less than 1.0 mg/dscm.

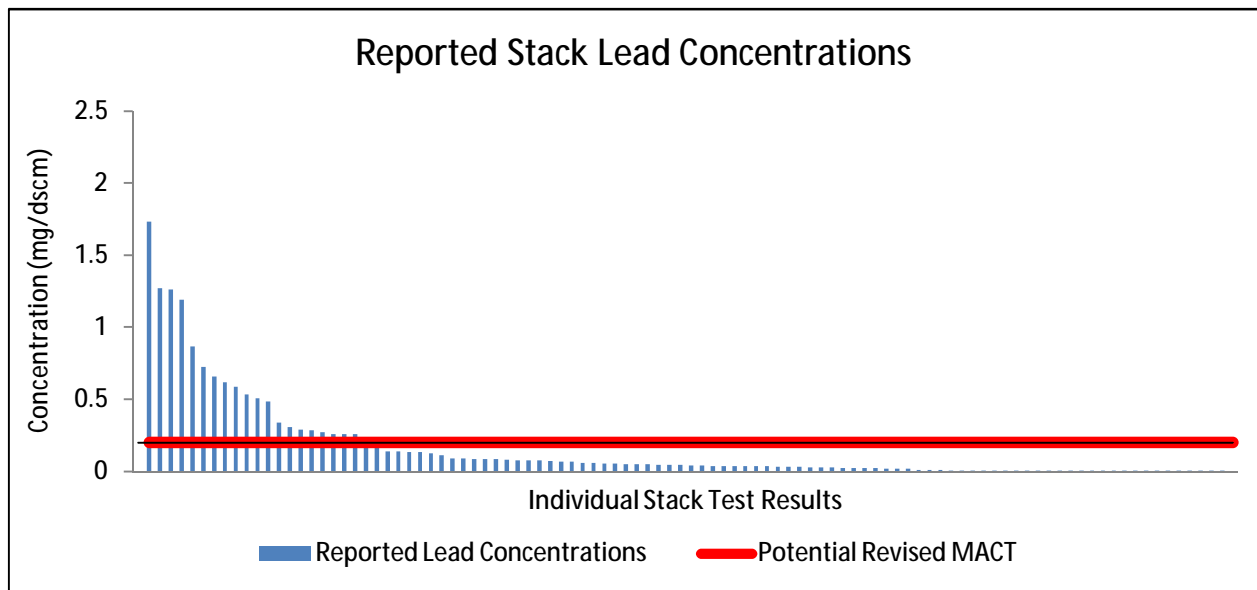

Figure 3-1. Comparison of Stack Lead Concentrations Reported by the Industry with a Potential Revised Lead Concentration Limit.

3.2 Fugitive Emissions

As outlined in section 2.2 of this memorandum, several facilities in this source category are currently implementing controls for fugitive emissions of metal HAP that exceed what is required in the current NESHAP. Based on our analyses, we are recommending revising the current NESHAP to reflect the level of control currently being achieved by the better performing facilities in this source category with regards to fugitive emissions of metal HAP.

Because fugitive emissions cannot be directly captured or measured, the most feasible limit is a work practice standard. Although lack of direct measurement makes comparisons of the efficiency of different control technologies challenging, analysis of ambient lead monitoring data near the facilities has generally been considered an accurate indicator of the level of fugitive emissions of metal HAP. The Draft Residual Risk Assessment for the Secondary Lead Smelting Source Category presents dispersion modeling results for this source category indicating that fugitive emissions are overwhelmingly the most significant source contributing to ambient lead concentrations near the property boundaries of secondary lead smelting facilities. The same modeling results indicate that fugitive lead emissions from this source category could result in exceedances of the lead NAAQS at 12 of the 14 facilities.

We analyzed available ambient monitoring data to determine which facilities were implementing the most effective controls for fugitive emissions of metal HAP. Figure 3-2

displays the annual average lead concentrations at ambient monitoring locations around facilities based on the enclosure category assigned to the facility in section 2.2 of this memorandum. The figure includes concentration data for 12 of the 14 facilities (monitoring data near Exide Baton Rouge and Exide Forest City were not available). All data in this figure were taken from http://www.epa.gov/airexplorer/monitor_kml.htm. The most recent year's monitoring data available (either 2008 or 2009 for each facility) was selected for each facility. In cases where data were available at multiple monitoring locations around a facility, we chose the monitor with the highest annual lead concentration.

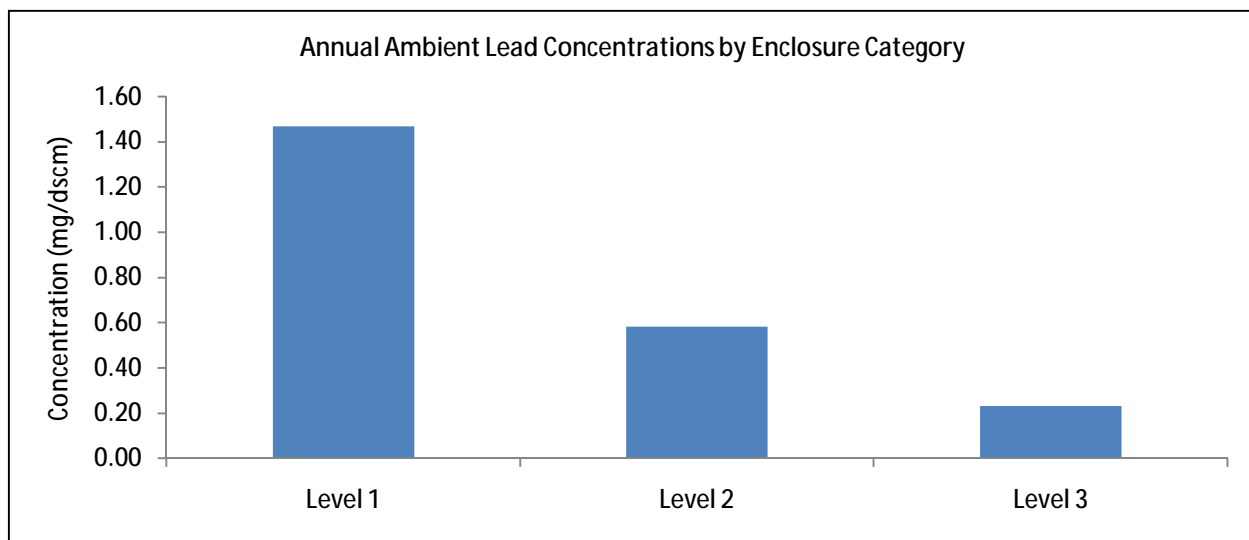

Figure 3-2. Comparison of Annual Ambient Lead Concentrations for Each Enclosure Category.

As the figure shows, facilities categorized as level 3 enclosures achieved significantly lower ambient lead concentrations than those classified as level 1 or 2 enclosures. As previously mentioned, seven of the 14 facilities are currently classified as level 3 enclosures, with an 8th facility planning to implement level 3 enclosures in the near future. Of the facilities classified as having level 3 enclosures, four facilities also implement some or all of the additional work practices mentioned in section 2.2 to further prevent the formation of fugitive dust in other areas of their facilities. Based on this analysis, we concluded that level 3 enclosure plus the implementation of additional fugitive control work practices is necessary to achieve ambient lead concentrations below the NAAQS near the fence line of a facility. Because several facilities are already implementing these controls and because we estimate that these controls are necessary to ensure to ensure ambient lead concentrations below the NAAQS, we recommend revising the current NESHAP to require these controls.

As with the revised stack lead concentration limit discussed in section 3.1 of this memorandum, we considered the potential cost impacts of revising the fugitive emissions standard in the current NESHAP to include the controls mentioned above. As described in the Draft Cost Impacts of the Revised NESHAP for the Secondary Lead Smelting Source Category, we estimate that the total capital cost to implement level 3 enclosure and additional fugitive control work practices throughout the industry is approximately \$40 million with a total annualized cost of approximately \$9.6 million. We estimate reductions in metal HAP emissions of 9.5 tons per year resulting from this revised standard with co-reductions of PM of approximately 104 tons. We do not anticipate any adverse non-air environmental impacts associated with this recommended standard. However, we do anticipate some additional energy use associated with the operation of the new total enclosure. After consideration of the costs, emissions reductions, and other potential impacts, we believe the revision of the fugitive emissions standard for this source category to include the control measures described in this memorandum is warranted and necessary.

As an alternative to requiring level 3 enclosure and the implementation of an extensive list of fugitive control work practices, we recommend that facilities be allowed to demonstrate compliance through ambient lead monitoring. If facilities are able to demonstrate ambient lead concentrations near their facility that are below the lead NAAQS using practices other than those specified above, then it can be concluded that they are achieving a similar level of control as would be achieved by the control measures described in this memorandum. Providing such an alternative would allow the facilities flexibility in determining the most appropriate and cost-effective method of achieving the necessary reductions in fugitive emissions of metal HAP.

4.0 CONCLUSIONS

This review identified several developments in practices, processes, or control technologies that have been implemented in this source category since promulgation of the current NESHAP. Our analysis indicates that several facilities have significantly reduced stack emissions of metal HAP, primarily through improved performance of baghouses. Additionally, several facilities have implemented fugitive emissions control practices that exceed the requirements of the current NESHAP. Based on our review, we conclude that it is feasible and cost-effective for facilities to achieve a facility-wide, flow-weighted average lead concentration of 0.2 mg/dscm with a limit of 1.0 mg/dscm for any individual stack. We conclude that it is feasible for all facilities to fully enclose all process areas under negative pressure of and implement a prescribed list of work practices to limit fugitive emissions. As an alternative, facilities could demonstrate a similar level of control for fugitive emissions by monitoring ambient lead concentrations at or near the facility boundaries to ensure that concentrations remain below the lead NAAQS (i.e., 0.15 $\mu\text{g}/\text{m}^3$). Implementing these controls would achieve

reductions in lead emissions of approximately 13.3 tons with total metal HAP reductions of approximately 15 tons. Additionally, we expect total co-reductions of PM emissions of approximately 160 tons. We estimate that between 48 and 76 tons of the total PM reductions will be reductions in particles with diameters less than 2.5 microns (PM_{2.5}), depending on the nature of the particle size distribution of emissions from this source category. For these reasons, we believe that these controls and measures are cost-effective measures that reflect achievable performance for this industry.

Appendix F

HB3151-25 Excess Emissions Calculation

APPENDIX F

EXIDE HB 3151-25 EXCESS LEAD EMISSIONS

Quemetco room ventilation baghouse exhaust lead concentrations test data

Baghouse ID	Pb Conc. ug/dscm
A	0.567
B	2.840
C	2.780
D	1.300
E	10.100
F	1.060
G	2.850
H	2.280
I	0.661

Average	2.715
----------------	--------------

Exide Torit dust collector exhaust lead concentrations test data

Collector ID	Pb Conc. ug/dscm
North	8.93
South	9.68

Average	9.305
----------------	--------------

HEPA control efficiency on R2 emissions (E)

$$E = (1 - 2.715/9.305) * 100 = \mathbf{70.819 \text{ Percent}}$$

Excess Pb Emissions (based on test data)

Collector ID	Pb, R2, lbs/hr	Excess Factor	Excess Pb, lbs/hr	Excess Pb, lbs/day
North	0.0029	0.7082	0.0020	0.0486
South	0.0042	0.7082	0.0030	0.0714
Totals	0.0071		0.0050	0.1200

Assumptions: Similar filter media have similar exhaust gas concentrations

Appendix D

Projected Health Risks following all Proposed Measures

Appendix D

Projected Health Risks After Implementing All Proposed Measures

ENVIRON conducted this health risk assessment (HRA) to project future health risks after Exide implements all the proposed control measures presented in the Risk Reduction Plan. Potential future control measures include a Regenerative Thermal Oxidizer (RTO) on the exhaust of the Reverberatory Furnace Feed Dryer and secondary HEPA filters on the Soft Lead, Material Handling, and MAC stacks. ENVIRON used the same air modeling and risk assessment methodologies as described in the approved January 2013 HRA, and substituted the emission data with the projected emissions that account for the RTO and the secondary HEPA filters.

D.1 Projected TAC Emissions

The main text of the RRP discussed the potential control efficiencies of the RTO (i.e., 90% reduction for organics) and the secondary HEPA filters (i.e., 50% reduction for metals). Table D-1 summarizes the TAC emissions using these control efficiencies. The 90% was applied to the organic TAC emissions reported for the Feed Dryer stack in the January 2013 HRA. The 50% was applied to the metal TAC emissions reported in the January 2013 HRA for the Feed Dryer, MAC baghouse, and Material Handling baghouse stacks and the metal TAC emissions in Appendix B for the Soft Lead stack. TAC emissions staying the same as those in the approved January 2013 HRA were not presented. Note that the secondary HEPA filters for the Feed Dryer stack had been installed already. However, the January 2013 HRA did not take any credit for such control.

D.2 Modeling and Risk Assessment Methods

This HRA repeated the risk calculations in the approved January 2013 HRA. Emission sources included all nine stacks of the manufacturing processes and two stacks for the natural gas water heaters as point sources, as well as the area sources representing the onsite entrained road dust. ENVIRON updated the emission data in the approved 2013 HRA with those listed in Table D-1. Entrained paved road dust emissions were revised slightly by using the k factor for PM₁₀ instead of PM₃₀ (AP-42 Section 13.2.1).

ENVIRON used the same XOQ files that were generated for the approved January 2013 HRA in this updated HRA. The regulatory default options were used to generate the XOQ values using Breeze AERMOD version 7.6 (EPA AERMOD version 12060). The source parameters were based on the source test reports that were used in the approved January 2013 HRA. The receptor grid covers a 3,600-square-kilometer area surrounding the facility, and census block receptors were identified within this area using United States Census Bureau data. ENVIRON obtained the meteorological data for the Central Los Angeles station from AQMD's website for the years of 2006 and 2007. The elevations for the sources and receptors were extracted from the National Elevation Datasets (NED) on the United States Geological Survey's (USGS) website. The modeling used the Universal Transverse Mercator (UTM) system of coordinates and the World Geodetic System 1984 (WGS84) spheroid.

ENVIRON used HARP (version 1.4f) to calculate the health risks, which is the same version that ENVIRON used for the approved January 2013 HRA and the currently available version on the California Air Resources Board (CARB)'s website. An updated HARP Health Value Database was released by CARB on August 1, 2013. This new database contains updated health values for 1,3-butadiene adopted by OEHHA and was used in this updated HRA. The newly adopted values are: $2 \mu\text{g}/\text{m}^3$ (chronic REL) and $660 \mu\text{g}/\text{m}^3$ (acute REL), compared to the $20 \mu\text{g}/\text{m}^3$ (chronic REL) and no acute REL previously.

ENVIRON used the same risk calculation parameters as those in the approved January 2013 HRA, which followed the OEHHA Air Toxics Hot Spots Program Guidance Manual for Preparation of Health Risk Assessment and the SCAQMD's Supplemental Guidelines for Preparing Risk Assessments for the Air Toxics "Hot Spots" Information and Assessment Act.

D.3 Risk Estimates

When the future controls are considered, the cancer risk at the Maximally Exposed Individual Worker (MEIW) is estimated to be 3.7 in a million or $3.7\text{E}-6$ (vs. 156 in a million in the January 2013 HRA). The MEIW is at Receptor 1005 (389900, 3763600) and is located in the railyard north of the facility. The cancer risk at the Maximally Exposed Individual Resident (MEIR) is estimated to be 1.2 in a million or $1.2\text{E}-6$ (vs. 22 in a million in the 2013 HRA). The MEIR is at Receptor 1016 (389900, 3764700) and is located in the residential area north of the facility. Both maximum cancer risks are below the AQMD Rule 1402 Action Risk Level of 25 in a million and the public notification threshold of 10 in a million.

The cancer burden is estimated to be 0.005, which is well below the AQMD Rule 1402 Action Risk Level of 0.5. The cancer burden in the January 2013 HRA was 10.

The maximum Chronic Hazard Index (CHI) for the worker scenario is estimated to be 0.4 (vs. 63 in the January 2013 HRA). The maximum CHI MEIW is at the same receptor as the MEIW. The maximum CHI for the residential scenario is estimated to be 0.04 (vs. 2.9 in the 2013 HRA). It is located at the same location as the MEIR. Both maximum CHIs are well below the AQMD Rule 1402 Action Risk Level of 3.0 and the public notification threshold of 1.0.

The maximum Acute Hazard Index (AHI) [i.e. Point of Maximum Impact (PMI)] is estimated to be 0.1 (vs. 3.8 in the January 2013 HRA). It is at Receptor 80 (389659, 3763479) and is located on the western fence line near the railway track. The maximum AHI for the residential scenario is estimated to be 0.008 (vs. 0.2 in the 2013 HRA). It is at the same receptor as the MEIR. The maximum AHIs are well below the AQMD Rule 1402 Action Risk Level of 3.0 and the public notification threshold of 1.0.

The maximum locations for the worker cancer risk, CHI, and AHI and the contour for the worker cancer risk on Figure D-1. The maximum locations for the residential cancer risk, CHI, and AHI and the contour for the residential cancer risk are presented on Figure D-2.

All electronic files, including emissions, modeling, and health risk calculations, are included in the CD-ROM in Appendix E of the RRP.

Tables

Table D-1 Reduced Emissions Following All Proposed Measures

Exide Technologies

Vernon, California

Stack	Chemical	CAS	Hourly Emission (lb/hr)
Material Handling Stack	Antimony	7440360	1.06E-05
Material Handling Stack	Arsenic	7440382	3.71E-05
Material Handling Stack	Beryllium	7440417	0
Material Handling Stack	Cadmium	7440439	2.61E-05
Material Handling Stack	Copper	7440508	1.41E-04
Material Handling Stack	Lead	7439921	5.75E-04
Material Handling Stack	Manganese	7439965	0
Material Handling Stack	Mercury	7439976	7.10E-07
Material Handling Stack	Nickel	7440020	1.98E-05
Material Handling Stack	Phosphorus	7723140	4.17E-04
Material Handling Stack	Selenium	7782492	0
Material Handling Stack	Zinc	7440666	1.12E-04
Material Handling Stack	Chromium VI	18540299	6.80E-06
Soft Lead Stack	Antimony	7440360	2.42E-05
Soft Lead Stack	Arsenic	7440382	4.12E-06
Soft Lead Stack	Beryllium	7440417	8.35E-06
Soft Lead Stack	Cadmium	7440439	1.86E-05
Soft Lead Stack	Copper	7440508	4.53E-06
Soft Lead Stack	Lead	7439921	2.70E-03
Soft Lead Stack	Manganese	7439965	5.70E-06
Soft Lead Stack	Mercury	7439976	5.20E-05
Soft Lead Stack	Nickel	7440020	5.85E-06
Soft Lead Stack	Phosphorus	7723140	2.06E-05
Soft Lead Stack	Selenium	7782492	4.54E-06
Soft Lead Stack	Zinc	7440666	1.60E-04
Soft Lead Stack	Chromium VI	18540299	6.25E-06
Soft Lead Stack	Vanadium	7440622	1.67E-05
Feed Dryer Baghouse/Cyclone	Antimony	7440360	2.15E-05
Feed Dryer Baghouse/Cyclone	Arsenic	7440382	1.33E-05
Feed Dryer Baghouse/Cyclone	Beryllium	7440417	0
Feed Dryer Baghouse/Cyclone	Cadmium	7440439	5.40E-06
Feed Dryer Baghouse/Cyclone	Copper	7440508	7.00E-06
Feed Dryer Baghouse/Cyclone	Lead	7439921	5.25E-03
Feed Dryer Baghouse/Cyclone	Manganese	7439965	5.65E-05
Feed Dryer Baghouse/Cyclone	Mercury	7439976	4.10E-05
Feed Dryer Baghouse/Cyclone	Nickel	7440020	4.75E-06
Feed Dryer Baghouse/Cyclone	Phosphorus	7723140	0
Feed Dryer Baghouse/Cyclone	Selenium	7782492	8.20E-07
Feed Dryer Baghouse/Cyclone	Vanadium	7440622	2.12E-06
Feed Dryer Baghouse/Cyclone	Zinc	7440666	2.12E-05
Feed Dryer Baghouse/Cyclone	Formaldehyde	50000	1.91E-03
Feed Dryer Baghouse/Cyclone	Acetaldehyde	75070	7.92E-04
Feed Dryer Baghouse/Cyclone	Naphthalene	91203	1.34E-03
Feed Dryer Baghouse/Cyclone	Benz(a)anthracene	56553	8.75E-09
Feed Dryer Baghouse/Cyclone	Chrysene	218019	5.21E-07
Feed Dryer Baghouse/Cyclone	Benzo(b)fluoranthene	205992	1.91E-08
Feed Dryer Baghouse/Cyclone	Benzo(k)fluoranthene	207089	0
Feed Dryer Baghouse/Cyclone	Benzo(a)pyrene	50328	0
Feed Dryer Baghouse/Cyclone	Indeno(1,2,3-cd)pyrene	193395	3.06E-09
Feed Dryer Baghouse/Cyclone	Dibenz(a,h)anthracene	53703	0
Feed Dryer Baghouse/Cyclone	TEQ (Min) as 2,3,7,8-TCDD	1086	7.80E-12

Table D-1 Reduced Emissions Following All Proposed Measures

Exide Technologies

Vernon, California

Stack	Chemical	CAS	Hourly Emission (lb/hr)
Feed Dryer Baghouse/Cyclone	Total PCBs	1336363	6.77E-05
Feed Dryer Baghouse/Cyclone	Chromium VI	18540299	1.69E-06
Feed Dryer Baghouse/Cyclone	Benzene	71432	1.88E-02
Feed Dryer Baghouse/Cyclone	Benzyl Chloride	100447	0
Feed Dryer Baghouse/Cyclone	Bromomethane	74839	8.09E-05
Feed Dryer Baghouse/Cyclone	2-Butanone	78933	4.98E-04
Feed Dryer Baghouse/Cyclone	Carbon Disulfide	75150	8.26E-04
Feed Dryer Baghouse/Cyclone	Carbon Tetrachloride	56235	0
Feed Dryer Baghouse/Cyclone	Chlorobenzene	108907	0
Feed Dryer Baghouse/Cyclone	Chloroethane	75003	0
Feed Dryer Baghouse/Cyclone	Chloroform	67663	4.10E-05
Feed Dryer Baghouse/Cyclone	1,1-Dichloroethane	75343	0
Feed Dryer Baghouse/Cyclone	1,1-Dichloroethene	75354	2.85E-05
Feed Dryer Baghouse/Cyclone	1,2-Dibromoethane	106934	0
Feed Dryer Baghouse/Cyclone	1,2-Dichloroethane	107062	0
Feed Dryer Baghouse/Cyclone	1,2-Dichloropropane	78875	0
Feed Dryer Baghouse/Cyclone	1,4-Dichlorobenzene	106467	0
Feed Dryer Baghouse/Cyclone	Ethylbenzene	100414	1.46E-04
Feed Dryer Baghouse/Cyclone	MTBE	1634044	0
Feed Dryer Baghouse/Cyclone	Methylene Chloride	75092	0
Feed Dryer Baghouse/Cyclone	xylene (mixed)	1330207	1.87E-04
Feed Dryer Baghouse/Cyclone	Styrene	100425	4.23E-04
Feed Dryer Baghouse/Cyclone	Tetrachloroethene	127184	0
Feed Dryer Baghouse/Cyclone	Toluene	108883	1.21E-03
Feed Dryer Baghouse/Cyclone	Trichloroethene	79016	4.11E-05
Feed Dryer Baghouse/Cyclone	Trichlorofluoromethane	75694	0
Feed Dryer Baghouse/Cyclone	1,1,2-Trichloro-1,2,2-Trifluoroethane	76131	0
Feed Dryer Baghouse/Cyclone	1,1,1-Trichloroethane	71556	0
Feed Dryer Baghouse/Cyclone	1,1,2-Trichloroethane	79005	0
Feed Dryer Baghouse/Cyclone	1,1,2,2-Tetrachloroethane	79345	0
Feed Dryer Baghouse/Cyclone	Vinyl Acetate	108054	4.29E-04
Feed Dryer Baghouse/Cyclone	Vinyl Chloride	75014	2.80E-05
Feed Dryer Baghouse/Cyclone	1,3-Butadiene	106990	1.67E-03
Feed Dryer Baghouse/Cyclone	1,4-Dioxane	123911	0
MAC Baghouse Stack	Antimony	7440360	1.06E-04
MAC Baghouse Stack	Arsenic	7440382	2.86E-05
MAC Baghouse Stack	Beryllium	7440417	0
MAC Baghouse Stack	Cadmium	7440439	0
MAC Baghouse Stack	Copper	7440508	0
MAC Baghouse Stack	Lead	7439921	2.86E-04
MAC Baghouse Stack	Manganese	7439965	0
MAC Baghouse Stack	Mercury	7439976	6.75E-07
MAC Baghouse Stack	Nickel	7440020	1.35E-05
MAC Baghouse Stack	Phosphorus	7723140	0
MAC Baghouse Stack	Selenium	7782492	0
MAC Baghouse Stack	Zinc	7440666	3.94E-04
MAC Baghouse Stack	Chromium VI	18540299	1.98E-05

Figures

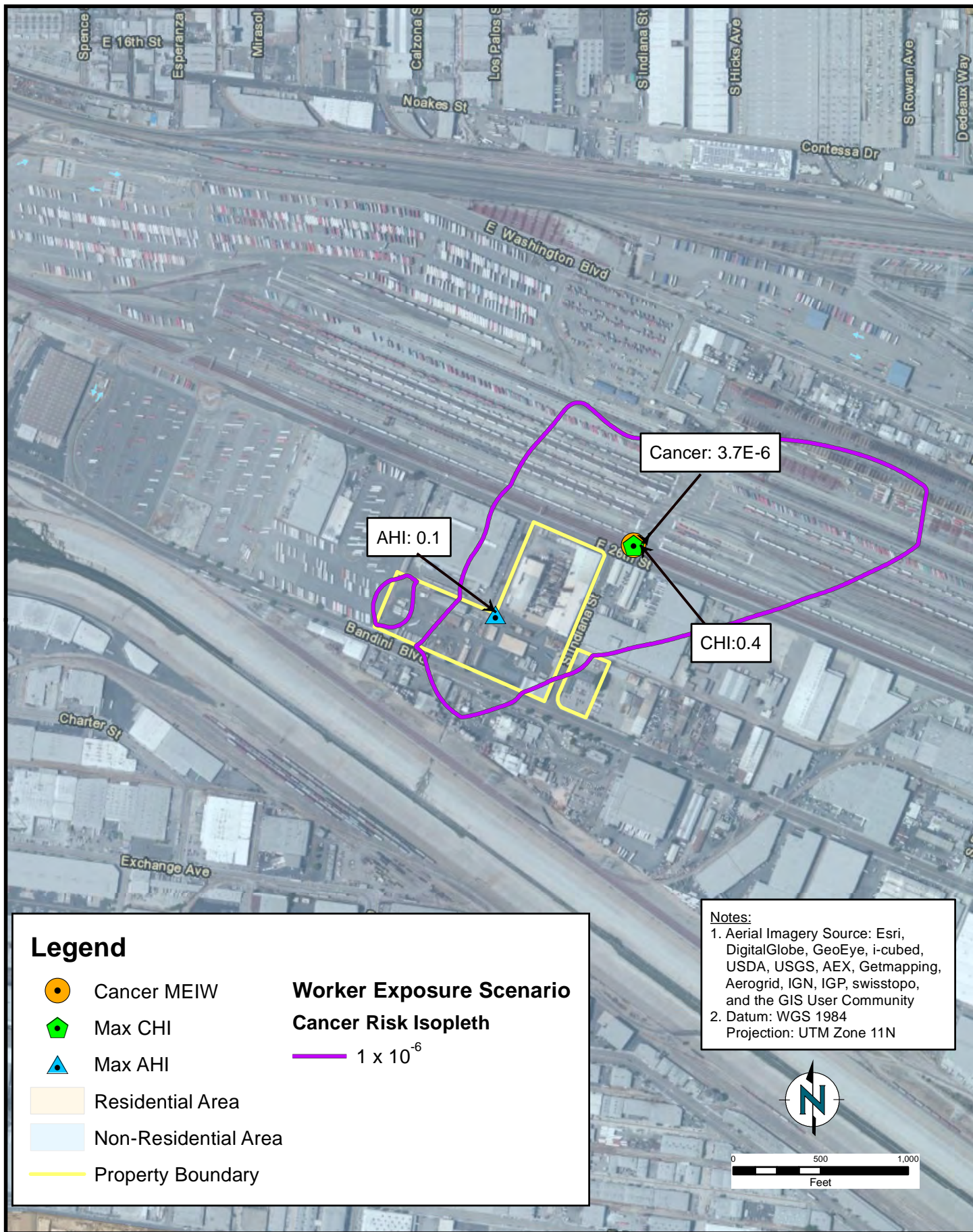

Legend

- Cancer MEIW
- Max CHI
- Max AHI
- Residential Area
- Non-Residential Area
- Property Boundary

Worker Exposure Scenario

Cancer Risk Isopleth

1×10^{-6}

Notes:

1. Aerial Imagery Source: Esri, DigitalGlobe, GeoEye, i-cubed, USDA, USGS, AEX, Getmapping, Aerogrid, IGN, IGP, swisstopo, and the GIS User Community
2. Datum: WGS 1984
Projection: UTM Zone 11N

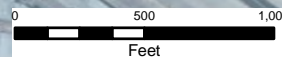

Path: Z:\01_Projects\Exide\03_GIS\HRA_2012_Update_Fall\RRP-Revised\Nov2013\0721624A_D1_RRP_Nov2013_worker_future.mxd



**Worker Exposure Risks Following
All Proposed Measures**

Exide Technologies
2700 South Indiana Street, Vernon, CA

**Figure
D-1**

UPDATED BY: XZLiu/MMG

DATE: 11/20/2013

PROJECT: 07-21624A

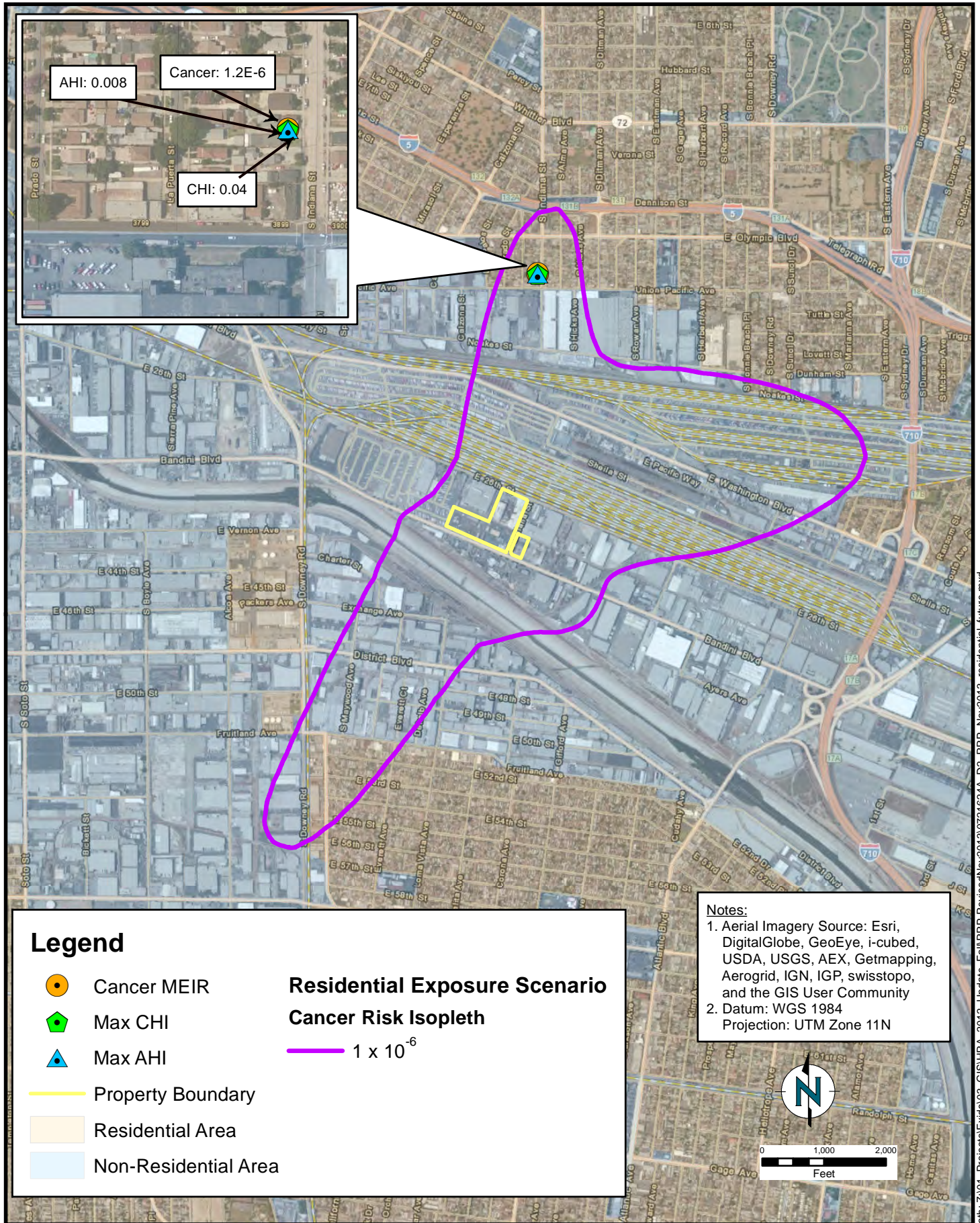

Path: Z:\01_Projects\Exide\03_GIS\HRA_2012_Update_Fall\RRP-Revised\Nov2013\0721624A_D2_RRP_Nov2013_residential_future.mxd

Appendix E

HRA CD-ROM

CD-ROM has already been submitted to AQMD

Appendix E

Description of Submitted Files in CD-ROM

- HARP tra files for Appendix B, B.d, and D
- EXIDE 2012 DISCRETE AND BDRY.SRC: grid and boudnary receptor HARP .src file
- EXIDE 2012 CENSUS.SRC: census receptor HARP .src file
- EXIDE 2012 DISCRETE AND BDRY.XOQ: grid receptor HARP .xoq file
- EXIDE 2012 CENSUS.XOQ: census receptor HARP .xoq file
- project-resident-census.sit: Site-specific parameters used for residential risk modeling scenario
- project-worker-sensitive.sit: Site-specific parameters used for worker risk modeling scenario
- ems files for Appendix B, B.d, and D
- HARP risk reports for Appendix B, B.d, and D

ATTACHMENT A

No.	REVISION	By	Date
B	Added Man Door	MB	3/3/14



LEAKAGE POINTS

LEAKAGE POINTS

EXISTING

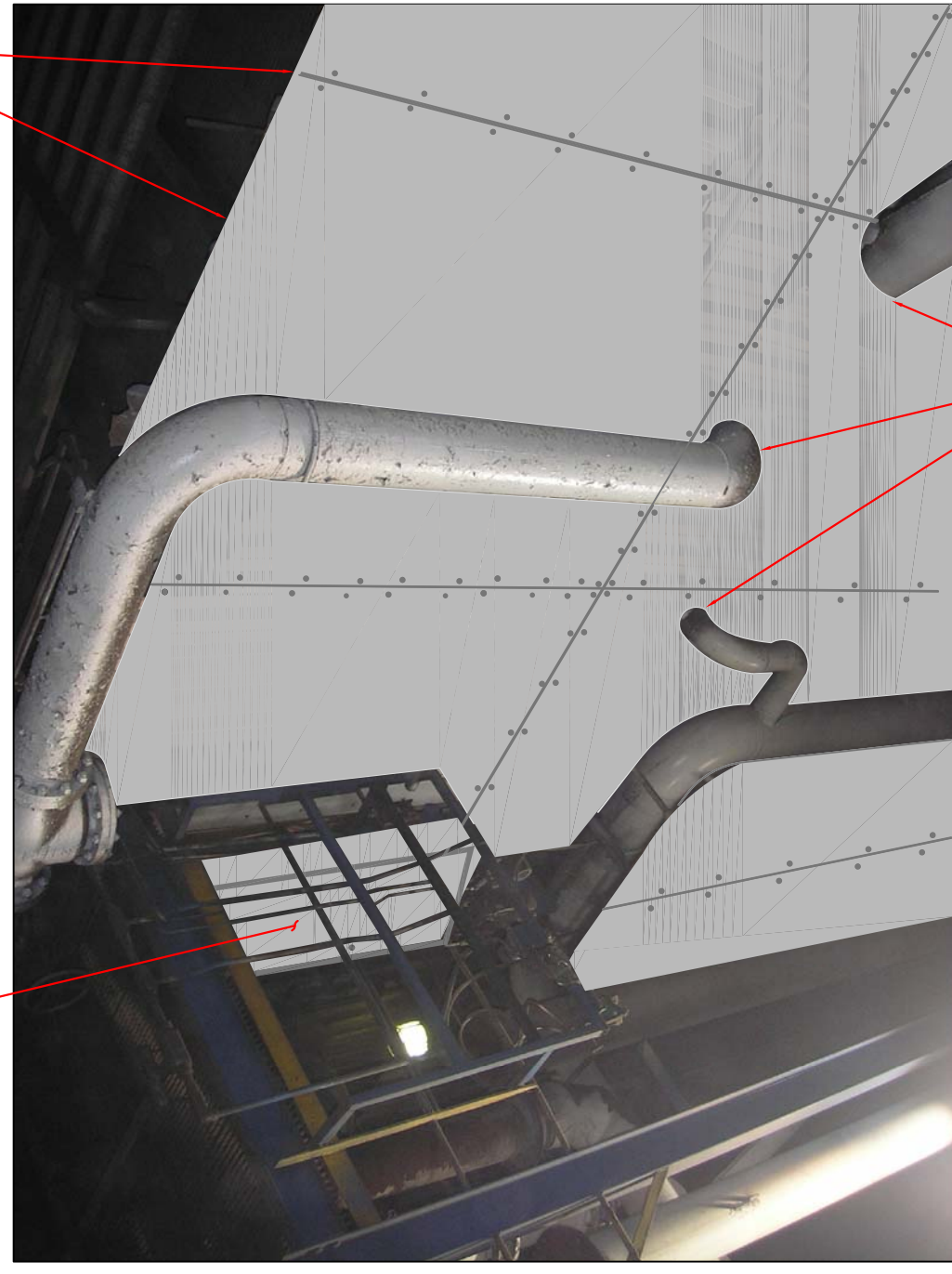

SEAL PENETRATION POINTS

REPLACE CORRUGATED METAL WITH 14GA A-36 C.S. SCREW TO EXISTING FRAME USING HIGH TEMP SILICONE AT EA SEAM

PROPOSED

MAN DOOR

BLAST FURNACE ENCLOSURE

The material is the property of INDUSTRIAL ACCESSORIES COMPANY and should not be reproduced, published or transmitted in any form or by any means, electronic, mechanical, photocopying, recording, or by any information storage and retrieval system, without authorization in writing from INDUSTRIAL ACCESSORIES COMPANY, Mission, Kansas.

IAC Industrial Accessories Company
 4803 JAMES MISSION, KANSAS 66202
 (913) 384-5511 fax (913) 384-8577

Customer: EXIDE TECHNOLOGIES
 VERNON, CA

Order No: 13201
 Date: 02/19/14
 Project: BF-1-1907-1A
 Sht. 1 of 1

BLAST FURNACE ENCLOSURE PROPOSAL

ATTACHMENT B

No.	REVISION	By	Date
-		-	



3'-6"

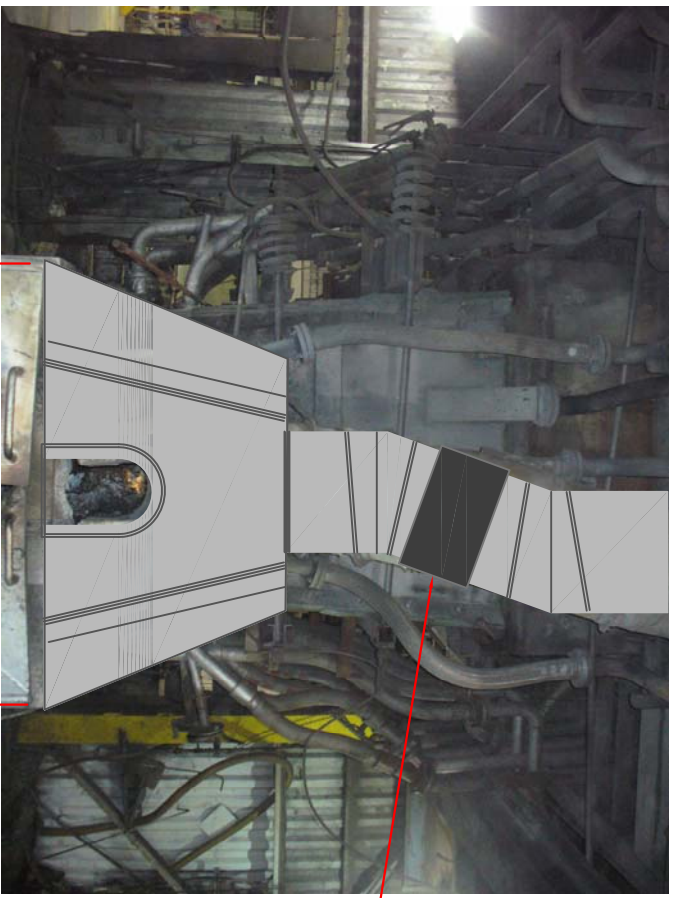

5'-0"

SLEEVED FOR MAINTENANCE



4'-0"

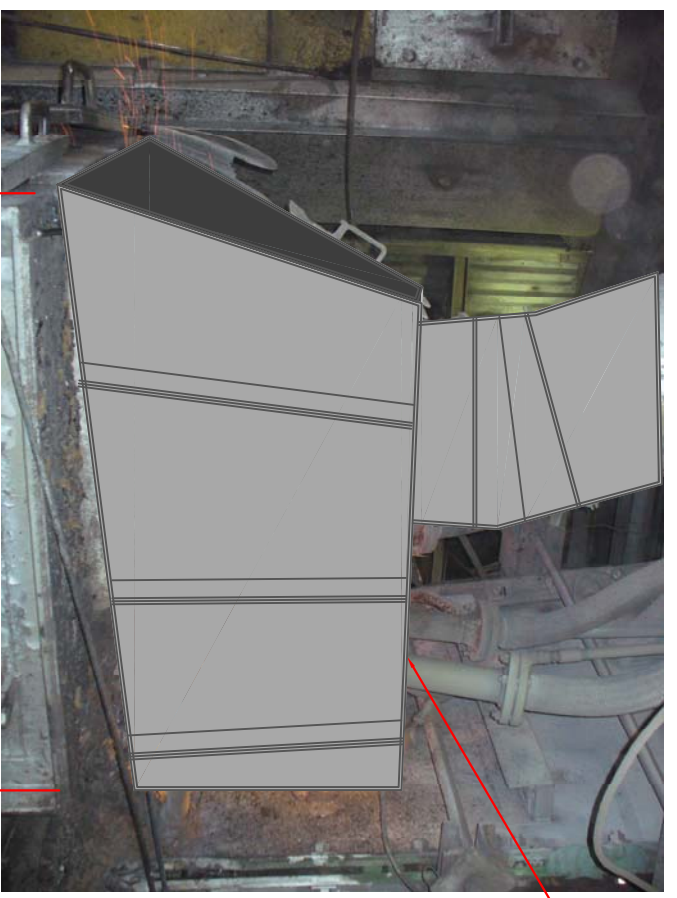

6'-3"

EXTEND HOOD

EXISTING

PROPOSED

SLAG TAP HOOD

The material in this proposal is the property of INDUSTRIAL ACCESSORIES COMPANY and should not be reproduced, published or used in any way without the written authorization of INDUSTRIAL ACCESSORIES COMPANY, Mission, Kansas.

IAC Industrial Accessories Company
 4800 JAMES
 MISSION, KANSAS 66202
 (913) 384-5511 fax (913) 384-6577

EXIDE TECHNOLOGIES
 VERNON, CA
 1

MB 02/19/14 NONE
 13201

SLAG TAP HOOD PROPOSAL
 Bf-1-1907-2
 Sht. 1 of 1

ATTACHMENT C

No.	REVISION	By	Date
G	ADDED RIO, CARTRIDGE FILTER, & FAN FOR CHARGE HOODS	DAY	7/30/14

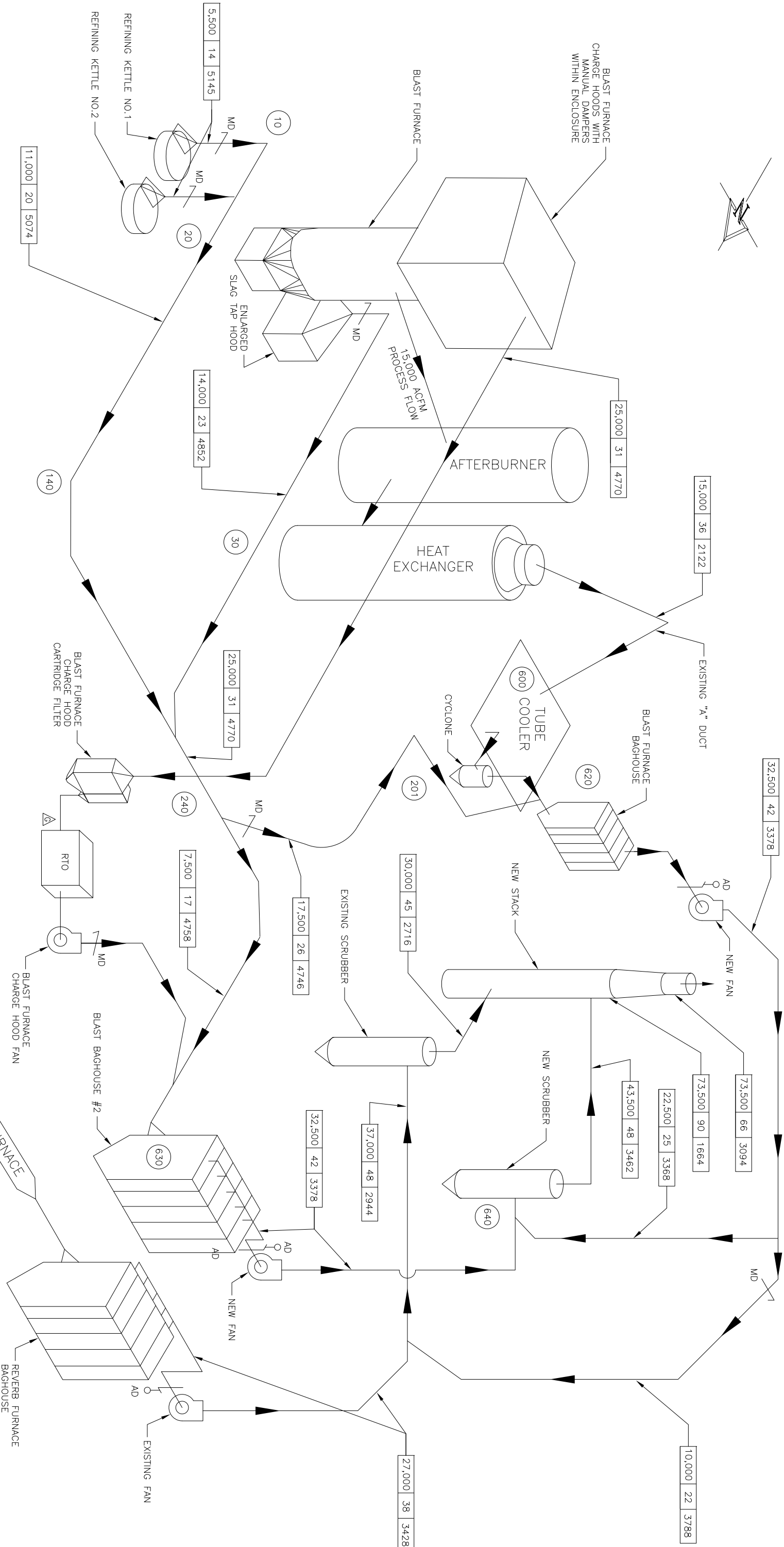

LEGEND:

FLOW (ACFM)	DUCT DIA. (IN.)	VELOCITY (FPM)
-------------	-----------------	----------------

NOTE: CIRCLED NUMBERS REFER TO DUCT ID NUMBERS IN STATIC PRESSURE CALCULATIONS.
 MD = MANUAL DAMPER
 AD = AUTOMATED DAMPER

This material is the property of Industrial Accessories Company and should not be reproduced, published, or distributed in any way without the written authorization of Industrial Accessories Company, Mission, Kansas.

IAC Industrial Accessories Company
 4800 JAMES MISSION, KANSAS 66202
 (913) 384-5511 fax (913) 384-6577

Customer: EXIDE TECHNOLOGIES
 VERNON, CA
 Date: 02/19/14
 Scale: NONE

Job No: 13201
 Drawing No: BF-1-1907-3
 Sht 1 of 1

RISK REDUCTION PLAN
 PROPOSAL

	A	B	C	D	E	F	G	H	I	J	K	L	M	N	O	P	Q	R	S
1	Exide Technologies, Vernon, CA																		
2	APC Risk Reduction Plan																		
3	IAC Job #E13201																		
4																			
5	APC Airflow Calculation Summary																		
6																			
7	Blast Furnace Process Flow						Flow from Auxiliary Hoods						Reverb Furnace Process Flow						
8	Vent						Vent						Vent						
9	Point	Description		ACFM	Note		Point	Description		ACFM	Note		Point	Description		ACFM	Note		
10																			
11	1	Blast Furnace Process Flow		15,000	1	2	Refining Kettle No. 1		5,500	1	6	Reverb Furnace Process Flow		27,000	1				
12																			
13						3	Refining Kettle No. 2		5,500	1									
14																			
15						4	Blast Furnace Slag Tap Hood		14,000	2									
16																			
17																			
18							Subtotal		25,000										
19																			
20		Flow Diverted from VPs 2, 3 & 4		17,500			Flow Diverted to Blast BH #1		-17,500										
21																			
22							Subtotal		7,500										
23																			
24						5	Blast Furnace Charge Hoods		25,000	3									
25																			
26		Blast Baghouse #1		32,500	4		Blast Baghouse #2		32,500	4		Reverb Furnace Baghouse		27,000	5				
27																			
28		Flow Diverted to Existing Scrubber		-10,000								Flow from Blast Baghouse #1		10,000					
29																			
30		Flow to New Scrubber		22,500			Flow from Blast Baghouse #1		22,500										
31																			
32							Flow to New Scrubber		55,000			Flow to Existing Scrubber		37,000					
33																			
34							Flow from New Scrubber		43,500	6		Flow from Existing Scrubber		30,000	6				
35																			
36																			
37							Flow from New Scrubber		43,500										
38																			
39							Flow from Existing Scrubber		30,000										
40																			
41							New 66" Diameter Stack		73,500	7									
42																			
43																			
44																			
45	Notes																		
46	1	Flow matches current design flow.																	
47																			
48	2	This flow is a 17% increase over the existing design flow.																	
49																			
50	3	This flow is the total for the 4 existing hoods above the furnace, which creates >200 fpm upward capture velocity within the furnace enclosure																	
51		after enclosure containment is improved. Velocity = 25,000 acfm/([(15'-0" x 10'-9" open area) - (6'-6" x 9'-6" furnace area)]) = 250 fpm																	
52																			
53	4	Air-to-cloth ratio = 32,500 acfm/26,390 ft2 = 1.2																	
54																			
55	5	Air-to-cloth ratio = 27,000 acfm/26,390 ft2 = 1.0																	
56																			
57	6	Flow from scrubber reduced due to decrease in flow temperature																	
58																			
59	7	Stack Exit Velocity = 73,500 acfm/[(5.5 ft) ² π/4] = 3,094 fpm																	
60																			

APPENDIX C

**APPROVED CONSTRUCTION OF RISK REDUCTION MEASURES,
RCRA RFI SAMPLING, AND OTHER PLANT ACTIVITIES,
JULY 2014**

MITIGATION PLAN
For
CONSTRUCTION of RISK REDUCTION MEASURES,
RCRA RFI SAMPLING,
AND OTHER PLANT ACTIVITIES

Prepared For:
Exide Technologies
2700 Indiana Street
Vernon, CA 90058

Prepared by:
Remediation Services, Inc.
Independence, KS

July 10, 2004

~~June 19, 2014~~

TABLE OF CONTENTS

	<u>Page No.</u>
1. Introduction.....	1
2. General Measures to Be Undertaken During Implementation of the Risk Reduction Construction, Maintenance Activities, RCRA RFI Activities and Other Plant Activities	1
a. Dust Removal.....	2
b. Continuous Air Monitoring.....	3
c. Damper Installation	4
d. Installation of High Speed Doors.....	4
e. Controlled Access to North Overhead Door.....	4
f. Decontamination Areas	4
g. Facility Trash and Debris	5
h. Drilling, Pavement Removal and Soil Activities	5
i. Third Party Oversight Consultant.....	5
3. Risk Reduction Activities and Specific Mitigation Measures.....	6
a. Blast Furnace Tray Type Wet Scrubbing System Installation.....	6
b. Hard Lead Ventilation System Modification	8
c. Installation of Blast Furnace Partial Enclosure	9
d. Installation of Blast Furnace Charge Level Sensor.....	10
e. Installation of Blast Furnace Temperature Sensor.....	10
f. Blast Furnace Ventilation Hood Modification	10
g. Reverb Furnace Feed Modification	11
h. Refining Kettle Ventilation Hood Modification	12
i. Installation of Regenerative Thermal Oxidizer	12
j. Installation of HEPA Filters	13
4. RCRA RFI Soil Sampling	14
5. Other Plant Activities and Specific Mitigation Measures.....	16
a. Reverb Furnace Activities	16
b. Blast Furnace Activities.....	16
c. Reverb A-Pipe Welding.....	17
d. Tank/Sump Repairs Tank 12 (Santa Maria Tank)	17
e. Tank/Sump Maintenance (Tank 24).....	18
f. Storm Water Piping Project Completion/Restoration.....	18
g. Refining Department Production Office Repairs	19
h. RMPS Feed Room Sprinkler Installation	19
6. Other Maintenance and Specific Mitigation Measures	20
a. Security Surveillance Camera Installation	20
b. Similar Plant and Maintenance Activities	20

1. Introduction

Remediation Services, Inc. (RSI) has prepared this Site Mitigation Plan to identify the measures that will be taken to monitor and minimize fugitive emissions of lead and other toxic metals associated with planned maintenance activities, RCRA RFI sampling activities, and facility modifications being conducted pursuant to the Final Risk Reduction Plan at Exide Technologies' Vernon Recycling Center. The goal of this plan is to exceed standard South Coast Air Quality Management District (SCAQMD) requirements pertaining to dust and emission controls to prevent emissions of lead and other toxic metals during those construction and maintenance activities. RSI anticipates that Exide Technologies (Exide's) mitigation activities at the Vernon facility will be coordinated with and overseen by a third party consultant retained by Exide. The name and qualifications of the third party consultant will be provided to AQMD 2 business days in advance of hiring the third party consultant.

the SCAQMD

As described below, Exide will implement general measures to minimize emissions during implementation of the Risk Reduction Construction activity, all maintenance activities, Other Plant Activities and the RCRA RFI sampling activities. In addition, Exide and their third party consultant will track the status of specific risk reduction activities that have been approved by the SCAQMD, and will implement the specific mitigation measures described in detail below during each respective step of the risk reduction construction, maintenance work and RCRA RFI sampling activities.

Exide

the SCAQMD's third

2. General Measures to Be Undertaken During Implementation of the Risk Reduction Construction, Maintenance Activities, RCRA RFI Activities and Other Plant Activities

Exide will undertake these General Measures during the entirety of performing the activities set forth herein.

Any and all maintenance activity(ies) as defined in SCAQMD Rule 1420.1(c)(17) shall be conducted in accordance with the requirements of Rule 1420.1(i) Maintenance Activity.

Except for work on the MAC baghouse until such time as HEPA filters are installed, total containment buildings shall be maintained under negative pressure and vented to HEPA filtration when electrical system modifications and maintenance work is performed through the use of rented temporary electrical power generators. HEPA filters will be installed on the MAC baghouse once Exide receives a permit. All temporary enclosures will have negative pressure and HEPA filtration.

Large piles of material such as slag, battery scrap or other lead containing material shall not be kept near the high-speed doors to prevent the release of fugitive emissions through the rollup doors when open.

Any maintenance or repair work, conducted on the facility's premises, to a HEPA vacuum, sweeper, or negative air machine shall only be performed inside of a total enclosure building maintained under negative pressure and vented to permitted air pollution control systems.

The established plant speed limit of 5 mph as required by the Basic Safety Orientation Form HS002, Rev 3.19.2014 shall be required of every Employee, Contractor and Visitor.

The maximum speed limit of no greater than 10 mph for vehicles on-site transporting material from inside an enclosure to areas outside an enclosure and no greater than 20 mph for any other vehicle on-site of the facility.

During all RCRA RFI sampling activities and maintenance activities, the plant grounds shall be swept at least twice per shift using a mobile HEPA sweeper. Records of the sweeping shall be kept and made available to SCAQMD staff, upon request.

During the RCRA RFI sampling and all maintenance activities, if at any time any of the six fence-line monitors obtain laboratory results showing a daily Excursion of lead greater than 0.15 ug/m³, Exide or their Contractors shall stop all RFI sampling and maintenance activities, and submit further mitigation measures to the SCAMD for review and approval.

During the RCRA RFI sampling and all maintenance activities, Exide shall designate an environmental staff person whose responsibility shall be to assure ongoing and sustained compliance with all applicable SCAQMD Rules and Regulations. This environmental designee shall be trained and knowledgeable of R1420.1 and R1420 and be empowered to expeditiously employ sufficient mitigation measures and stop work to gain facility compliance.

Downwind monitoring with TSI DustTraks (Dust Traks) should also be performed for all RCRA RFI maintenance/construction/demolition activities (activities) conducted outside of an enclosure building (including any activities conducting in a portable enclosure even if vented to HEPAs). The number of DustTraks utilized downwind should be in proportion to the degree of wind direction variance with one unit for each 30 degrees of wind direction variance. The values should be recorded every 15 minutes. As observing personnel note potentially adverse dust evolution using these devices in conjunction with visual observation and experience, they shall direct work stoppage and then direct adjustments in the work practices and/or the applied control measures as appropriate. In response to adverse visual observations or DustTrak results the mitigation measures as discussed in the Mitigation Plan shall be implemented. Records of DustTrak monitors, including time and locations, shall be recorded and kept on site and made available upon request by SCAQMD staff.

a. Dust Removal

Prior to the start of construction on any of the risk reduction equipment or Other Plant Activities within any total enclosure buildings, accumulated dust that may contain lead or other toxic metals will be removed from horizontal surfaces, such as building columns, upper rafters and supports, and from equipment that will be modified during the construction activities. This dust will be recycled through the existing dust conveyance, which converts the dust into water slurry. That slurry will then be sent to the filter press circuit. This dust removal process will be completed using wet wash down methods and/or High Efficiency Particulate Air equipped vacuums.

b. Continuous Air Monitoring

The third party oversight contractor will utilize hand-held continuous particulate aerosol monitors (TSI DustTrak or equivalent) which work on the principle of optical scatter from aerosols both inside and outside the enclosures during all risk reduction construction and maintenance activities. Such devices were utilized by the contractors and Exide oversight personnel during the recent storm water piping replacement effort. As may be relevant to the particular work aspect at hand, these devices will be deployed on a stand downwind and potentially upwind of a work function to track and gauge the trending in particulate dust generation during work progress. Each Dust Trak Unit will cover 30° of wind direction change. An appropriate number of Dust Trak units will be deployed for each project depending on the wind direction and location of the work. When the wind direction is outside the capture zone of at least one Dust Trak unit the work will be stopped until the Dust Trak unit(s) can be relocated. As observing personnel note potentially adverse dust evolution using these devices in conjunction with visual observation and experience, they shall direct work stoppage and then direct adjustments in the work practices and/or the applied control measures as appropriate. In response to adverse visual observations or DustTrak results the mitigation measures as discussed in the Mitigation Plan shall be implemented.

In response to adverse visual observations or DustTrak results Exide shall implement the following increased dust suppression activities. These increased dust suppression abatement activities will include, but are not limited to the following:

- Stop all work outside of any total enclosure building that has the potential to generate lead or other toxic metals containing dust. Negative air filtration units installed on enclosures will remain in operation for the duration of the stop work order. Equipment that was being used inside of the total enclosure building shall remain in place during the stop work period.
- Immediately begin application of water on all paved areas.
- Stop all onsite vehicle traffic outside of all total enclosure building.
- All overhead doors on any total enclosure building are to remain closed.
- Determine if there are any activities within any total enclosure building that could be contributing to the increase in dust concentration. If so stop that activity.
- Determine if there are any offsite activities that are being conducted by others that are contributing to the increase in dust concentration. If so, suspend all activities outside of total enclosure buildings that have the potential to generate lead and other toxic metals containing dust until additional dust mitigation has been implemented or the activity completed and the areas both on-site and off-site are cleaned.

The abatement activities described above will remain in effect until Exide and the ~~the~~ third party consultant determine the cause of the adverse readings and additional dust mitigation for the activity that caused the increase in dust concentration has been implemented.

If the cause of the adverse Dust Trak readings cannot be attributed to any one activity of total enclosure buildings and no activity within any total enclosure building, the work outside of the total enclosure building will be restarted on a rolling basis with the activity that would be expected to generate the least amount

of lead containing dust starting first. No work may resume until DustTrak readings show that the adverse dust condition does not exist anymore.

The real time data from the DustTraks will be continuously monitored during this rolling start to determine if there is an increase in the dust concentrations following the restart of any one activity. If an increase is noted after restarting any activity, that activity will be stopped until additional dust suppression measures have been implemented. The rolling start activities following the activity that caused the increase in dust consideration may be restarted using the basis described above with continuous monitoring of the real time particulate data to insure none of the follow on activities causes an increase in the total particulate concentration. If after work resumes, DustTrak readings show adverse dust conditions, the dust suppression and abatement activity described above shall be implemented. All dust measurements obtained by DustTraks during the activities described in this Mitigation Plan must be maintained in an electronic format and be made available to SCAQMD staff upon request.

c. Damper Installation

Manual dampers will be installed on the makeup air inlet louvers of the baghouse row total enclosure building to close and prevent the escape of particulates in order to enhance emission control.

d. Installation of High Speed Doors

High speed doors will be installed on the two overhead doors, one on the north end of the baghouse building and one on the south end of the Corridor. To minimize the potential for loss of negative pressure during installation of the doors, temporary total enclosures will be installed on the exterior of the door prior to removal of the existing door. The temporary total enclosures will be constructed by installing a frame covered with heavy fire resistant reinforced plastic sheeting that is fastened to the building skin. No activities shall be conducted in the baghouse building or corridor from the time the existing doors are removed until the new high-speed doors are installed.

e. Controlled Access to North Overhead Door

Use of the north overhead door in the baghouse building will be minimized and access controlled to minimize emissions from the baghouse building.

f. Decontamination Areas

Each overhead door location will be equipped with potable water to be used to decontaminate any materials and equipment prior to transfer outside of the total enclosure buildings. The overhead door will remain closed during all decontamination activities to prevent the release of contaminated overspray out of the building. The decontamination area floor will be cleaned prior to removal of the piece of equipment to ensure lead residue is not transferred outside of the total enclosure building.

g. Facility Trash and Debris

All facility trash and debris designated for offsite disposal will be placed in covered containers prior to transfer to the rolloff container. The rolloff container will be covered when materials are not being actively placed into it. The exterior of the rolloff container will be taken to the decontamination area in the Corridor and cleaned with potable water prior to removal from the plant.

Roll-off Containers that are to be used to transport scrap metal, concrete, soil, or any construction or demolition debris shall be totally contained where no dust or liquid leaking is allowed during transport.

h. Drilling, Pavement Removal and Soil Activities

All concrete or asphalt cutting/drilling performed outside total enclosure buildings shall be performed under 100% wet conditions and fully comply with the provisions of Rule 1420.1(i).

Grading of soils prior to pouring concrete or asphalt paving shall only be performed if soil surface that will be disturbed has at minimum 12% moisture content

Any soil grading/leveling project which has the potential to generate any dust whatsoever shall be performed under temporary negative pressure enclosures maintained through the use of permitted HEPA negative air machines. Apply water or a stabilizing agent in sufficient quantities to prevent the generation of visible dust plumes when the work area is not immediately to be covered by concrete, asphalt, paving material, etc.

The liquid run off from areas that are wetted shall be contained or directed into drains so as not to allow the liquid run off to evaporate and cause a secondary means of dust to be entrained into the air.

Any drilling, pavement removal, and soil disturbing activities outside of the total enclosure buildings will be performed only when outdoor sustained wind velocities are less than 12 MPH and instantaneous gusts are less than 20 mph, which is more stringent than required by South Coast Air Quality Management District (AQMD) Rule 1420.1. Any work of this type on Exide's property will be completed in an enclosure with negative air and HEPA filtration.

i. Third Party Oversight Consultant

SCAQMD

and Exide

Exide will contract with a third party consultant to oversee and document the mitigation activities performed during the maintenance, RFI sampling, and risk reduction activities described below, and will provide weekly reports to the District regarding the Mitigation Plan activities and progress on Friday of each week. Reports shall include activities conducted up to 24 hours following implementation of mitigation activities.

The following are the specific additional mitigation measures planned for the various activities being undertaken.

3. Risk Reduction Activities and Specific Mitigation Measures

a. Blast Furnace Tray Type Wet Scrubbing System Installation

Description of Construction:

A new venturi and tray type wet scrubbing system will be installed to serve the main air pollution control system (APCS) function for the blast furnace, removing this load from the existing Neptune scrubbing system. The new system will be moved into the plant using forklifts using an existing overhead door. The existing Neptune scrubber will continue in service for the reverberatory furnace. Installation of this second wet scrubbing system will allow the primary process draft to each furnace to be managed independently to reduce emissions and maintain appropriate pressure in both furnaces pursuant to amended AQMD Rule 1420.1. This modification will also reduce emissions of metal and organic constituents as limited in amended AQMD Rule 1420.1. Both scrubbers (existing and new) will discharge to a new, larger single stack.

The majority of the work will be completed within the total enclosure building with negative pressure and HEPA air filtration. The work will include the removal and replacement of the existing stack and stack support structure which extends through the roof. The work will include the removal of the existing floor and limited amounts of soil to allow installation of new concrete foundations. Any work conducted outside the enclosure buildings will be subject to the mitigation measures listed under Section 2 of this document.

Specific Mitigation Measures for Foundation Installation:

Prior to removal of the existing floor and underlying soil to allow installation of the foundations for the new scrubber system, the existing floor will be thoroughly cleaned using HEPA vacuums followed by washing with potable water. The construction contractor will saw the concrete using wet methods to minimize generation of dust. The concrete being removed will be kept damp to minimize the generation of dust during the concrete demolition and removal activities. Additional dust control will include applying a fine water mist directly on the demolition hammer point during the demolition activities. A fine water mist will also be applied to the concrete and soil as it is being excavated to minimize the generation of dust.

Concrete and soil will be transferred into a rolloff container that is staged inside of the total enclosure building, which will minimize trips into and out of the building and minimize the possibility of any dust generated by placing the concrete and soil into the container being released into the environment. The rolloff container will be covered when not in use and the exterior will be washed with potable water and tarped prior to removal to outside any enclosure buildings.

Specific Mitigation Measures for Removal and Replacement of the Existing Stack and Stack Support System

A scaffold system will be installed on the roof to provide a means to construct a total enclosure around the existing Neptune Scrubber stack and associated stack support structure prior to their removal. The scaffold will be totally enclosed using reinforced fire resistant poly sheeting. The enclosure around the Neptune Scrubber stack and scaffold will be operated under negative pressure and vented to a HEPA filtration control device. The roof in the area of the scaffolding will be cleaned using HEPA vacuums and washed prior to installation of the scaffolding. The underside of the roof and roof support system will be cleaned to remove accumulated dust using HEPA vacuums. The underside of the roof will be washed promptly after the enclosure on the roof has been installed. All water used for washing the roof areas shall be captured and treated properly to prevent a secondary means of fugitive emissions into the air.

Once the exterior scaffold has been erected and enclosed, the structure that supports the existing Neptune Scrubber stack will also be wrapped with fire resistant poly sheeting to provide secondary protection. The installation of the secondary enclosure will be completed by accessing the pipe support structure from inside of the building.

A crane will be used to lower the existing Neptune Scrubber stack and support structure into the building. A small hole, approximately 1 foot in diameter, will be cut in the top of the temporary enclosure to allow the crane rigging to be attached to the stack and support structure. The existing Neptune Scrubber stack and support structure will then be lowered into the total enclosure building for dismantling. Each section will be removed as it is cut away from the sections above using forklifts or cranes working inside of the total enclosure building.

Because some modifications to the roof and roof support system will be required to allow installation of the new stack and support system, the inside of the roof and roof support structure will be inspected and re-cleaned prior to beginning the modifications. This work will be completed with the temporary enclosure in place, and Exide and the third party consultant will ensure that there is sufficient inward air velocity through any openings (minimum 300 fpm measured at the opening using a handheld anemometer) to prevent dust that is generated during the work from migrating into the temporary enclosure constructed on the roof.

The new stack and support structure will be lowered into the building using a crane. A hole, large enough to allow placement of the equipment through the temporary structure, will be cut in the top of the plastic enclosure immediately prior to the installation. Once the structure has been lowered into place, the top of the temporary structure will be replaced to minimize the size of the opening to only what is required for the crane rigging.

After the new stack and structure have been installed, the roof will be repaired from within the containment structure. If access into the temporary structure is required from the roof, an airlock-type temporary door with at least 300 fpm draft, verified using a handheld anemometer, will be constructed to provide access into and out of the temporary enclosure.

Once the work is complete, the roof and interior of the temporary structure will be cleaned using HEPA equipped vacuums to remove any dust prior to removal. A wipe test will then be performed on each side and the top of the enclosure as well as the floor (top of the roof) using a Lead Wipe Test Kit (ESCA Tech Inc. Lead Test Kit). A yellow color indicates lead is present and additional cleaning is required. The additional cleaning will consist of wet wiping using a D-lead solution. No color change indicates no lead is present. All 5 test locations must have a negative result prior to proceeding with dismantlement.

b. Hard Lead Ventilation System Modification

Description of Construction:

Ventilation hoods now connected to the Hard Lead Ventilation System serving the charging area at the top of the blast furnace will be redirected to the inlet side of an enhanced afterburner so that those gases will be directed through the main APCS train serving the blast furnace, including the afterburner and subsequent new wet scrubber.

This work will be completed within the total enclosure building under negative pressure with HEPA air filtration.

Specific Mitigation Measures:

All stacks associated with modifications of air pollution control system equipment shall be capped and sealed prior to removal of hermetic external seals, prior to restarting systems.

All stacks associated with air pollution control system modifications shall be thoroughly cleaned internally prior to removal of hermetic external seals, prior to restarting systems.

During any welding or torching on the ventilation system, the baghouse will be shut down until the welding or torch work is complete. If the work is on a vent duct that is not on the main ventilation run, then that specific vent duct will be blanked off of the main duct ~~This will allow~~ while the baghouse continues to operate, if flanges are already installed to allow for the blank. If welding or torch work is needed when the vent duct leg is ready to be put back into service, the baghouse will be shut down for the required time and then restarted.

Spark arrestors or equivalent precautions shall be employed when hot work will be vented to dry filter media.

All materials removed will be washed with potable water prior to placement into a container for proper offsite disposal or recycling. The scrap will be placed into a rolloff container that is staged inside of the total enclosure building. Staging the rolloff container inside of the total enclosure building will minimize trips into and out of the building as well as minimize the possibility of dust being released into the environment that could be generated when placing materials into the rolloff container. The rolloff container will be covered when not in use and the exterior will be washed with potable water and tarped prior to removal to outside of any enclosure buildings.

All pipe/duct/other materials which are too large for the scrap rolloffs shall be cut down to shipping sized, washed with potable water, and hermetically sealed prior to removal from the total enclosure buildings, and prior to placement on vehicles for export outside of facility.

c. Installation of Blast Furnace Partial Enclosure

Description of Construction:

A new enclosure within the overall blast furnace partial enclosure will be installed around the furnace charge area to serve as a secondary hood to enhance capture of gases escaping the charge isolation door by the hoods at the top of this enclosure. The current partial enclosure in which the blast furnace resides will be enhanced with sealed siding and close-fitting doors.

This work will be completed within the total enclosure building under negative pressure with HEPA air filtration.

Specific Mitigation Measures:

All stacks associated with modifications of air pollution control system equipment shall be capped and sealed prior to removal of hermetic external seals, prior to restarting systems.

All stacks associated with air pollution control system modifications shall be thoroughly cleaned internally prior to removal of hermetic external seals, prior to restarting systems.

During any welding or torching on the ventilation system, the baghouse will be shut down until the welding or torch work is complete. If the work is on a vent duct that is not on the main ventilation run, then that specific vent duct will be blanked off of the main duct. ~~This will allow~~ while the baghouse continues to operate, if flanges are already installed to allow for the blank. If welding or torch work is needed when the vent duct leg is ready to be put back into service, the baghouse will be shut down for the required time and then restarted.

Spark arrestors or equivalent precautions shall be employed when hot work will be vented to dry filter media.

All materials removed will be washed with potable water prior to placement into a container for proper offsite disposal or recycling. The scrap will be placed into a rolloff container that is staged inside of the total enclosure building. Staging the rolloff container inside of the total enclosure building will minimize trips into and out of the building as well as minimize the possibility of dust being released into the environment that could be generated when placing materials into the rolloff container. The rolloff container will be covered when not in use and the exterior will be washed with potable water and tarped prior to removal to outside of any enclosure buildings.

d. Installation of Blast Furnace Charge Level Sensor

Description of Construction:

A radar-based charge level sensor will be installed within the blast furnace in order to provide operators with ongoing data regarding the level of the feed burden within the furnace. The work includes installation of the sensor and instrument cables from the blast furnace to the control room and power to the device.

This work will be completed within the total enclosure building under negative pressure with HEPA air filtration.

Specific Mitigation Measures:

The sensor installation holes have been completed. The remaining work to insert the probes, run cabling and make the connections will not require any mitigation measures.

e. Installation of Blast Furnace Temperature Sensor

Description of Construction:

A temperature sensor will be installed within the top of the blast furnace as an additional operational indicator of charge level. The work includes installation of the sensor and instrument cables from the blast furnace to the control room and power to the device.

This work will be completed within the total enclosure building under negative pressure with HEPA air filtration.

Specific Mitigation Measures:

The sensor installation holes have been completed. The remaining work to insert the probes, run cabling and make the connections will not require any mitigation measures.

f. Blast Furnace Ventilation Hood Modification

Description:

The ventilation hood now connected to the Hard Lead Ventilation System serving the slag tap of the blast furnace will be enlarged and then it will be served with greater air flow. This air will be redirected to the new Blast Furnace #2 baghouse that will be routed to the new wet scrubbing system.

This work will be completed within the total enclosure building under negative pressure with HEPA air filtration.

Specific Mitigation Measures:

All stacks associated with modifications of air pollution control system equipment shall be capped and sealed prior to removal of hermetic external seals, prior to restarting systems.

All stacks associated with air pollution control system modifications shall be thoroughly cleaned internally prior to removal of hermetic external seals, prior to restarting systems.

During any welding or torching on the ventilation system, the baghouse will be shut down until the welding or torch work is complete. If the work is on a vent duct that is not on the main ventilation run, then that specific vent duct will be blanked off of the main duct ~~This will allow~~ while the baghouse continues to operate, if flanges are already installed to allow for the blank. If welding or torch work is needed when the vent duct leg is ready to be put back into service, the baghouse will be shut down for the required time and then restarted.

Spark arrestors or equivalent precautions shall be employed when hot work will be vented to dry filter media.

All materials removed will be washed with potable water prior to placement into a container for proper offsite disposal or recycling. The scrap will be placed into a rolloff container that is staged inside of the total enclosure building. Staging the rolloff container inside of the total enclosure building will minimize trips into and out of the building as well as minimize the possibility of dust being released into the environment that could be generated when placing materials into the rolloff container. The rolloff container will be covered when not in use and the exterior will be washed with potable water and tarped prior to removal to outside of any enclosure buildings.

g. Reverb Furnace Feed Modification

Description of Construction:

The existing ram feeding mechanisms on the reverberatory furnace will be replaced with screw feeders to reduce the potential for organic-bearing process gases to be drawn into the Soft Lead Ventilation System pickup hooding when the ram feeders cycle.

This work will be completed within the total enclosure building which is under negative pressure with HEPA air filtration.

Specific Mitigation Measures:

The ram feeders will be washed with potable water prior to cutting into manageable pieces for offsite recycling. The scrap will be placed into a rolloff container that is staged inside of the total enclosure building. Staging the rolloff container inside of the total enclosure building will minimize trips into and out of the building as well as minimize the possibility of dust being released into the environment that could be generated when placing materials into the rolloff container. The rolloff container will be covered when not in use and the exterior will be washed with potable water and tarped prior to removal to outside of any enclosure buildings.

h. Refining Kettle Ventilation Hood Modification

Description of Construction:

The ventilation ducting serving two refining kettles will be removed from the Hard Lead Ventilation System and redirected to the new Blast Furnace #2 baghouse that will be routed to the new wet scrubbing system. In the future, arsenic additions in refining operations will be restricted to these two kettles.

This work will be completed within the total enclosure building which is under negative pressure with HEPA air filtration.

Specific Mitigation Measures:

All stacks associated with modifications of air pollution control system equipment shall be capped and sealed prior to removal of hermetic external seals, prior to restarting systems.

All stacks associated with air pollution control system modifications shall be thoroughly cleaned internally prior to removal of hermetic external seals, prior to restarting systems.

During any welding or torching on the ventilation system, the baghouse will be shut down until the welding or torch work is complete. If the work is on a vent duct that is not on the main ventilation run, then that specific vent duct will be blanked off of the main duct. This will allow while the baghouse continues to operate, if flanges are already installed to allow for the blank. If welding or torch work is needed when the vent duct leg is ready to be put back into service, the baghouse will be shut down for the required time and then restarted.

Spark arrestors or equivalent precautions shall be employed when hot work will be vented to dry filter media.

All materials removed will be washed with potable water prior to placement into a container for proper offsite disposal or recycling. The scrap will be placed into a rolloff container that is staged inside of the total enclosure building. Staging the rolloff container inside of the total enclosure building will minimize trips into and out of the building as well as minimize the possibility of dust being released into the environment that could be generated when placing materials into the rolloff container. The rolloff container will be covered when not in use and the exterior will be washed with potable water and tarped prior to removal to outside of any enclosure buildings.

i. Installation of Regenerative Thermal Oxidizer

Description of Construction:

A regenerative thermal oxidizer (RTO) will be installed on the reverberatory furnace feed dryer exhaust to reduce emissions of organic gases. The work will include the removal of the existing floor and limited amounts of soil to allow installation of concrete foundations. The concrete joints will be sealed by installing Sonolastic® SL1™ or equivalent.

This work will be completed within the total enclosure building which is under negative pressure with HEPA air filtration.

Specific Mitigation Measures for Concrete and Soil Removal:

Prior to removal of the existing floor and underlying soil to allow installation of the foundations for the new RTO, the existing floor will be thoroughly cleaned using HEPA vacuums followed by washing with potable water. The construction contractor will saw the concrete using wet methods to minimize generation of dust. The concrete being removed will be kept damp to minimize the generation of dust during the concrete demolition and removal activities. Additional dust control will include applying a fine water mist directly on the demolition hammer point during the demolition activities. A fine water mist will also be applied to the concrete and soil as it is being excavated to minimize the generation of dust. All water used for washing the floor and for other uses shall be captured and treated properly to prevent a secondary means of fugitive emissions into the air.

Concrete and soil will be transferred into a rolloff container that is staged inside of the total enclosure building, for proper off-site disposal or recycling which will minimize trips into and out of the building and eliminate the possibility of any dust generated during placement of the concrete and soil into the container being released into the environment. The rolloff container will be covered when not in use and the exterior will be washed with potable water and tarped prior to removal to outside of any enclosure buildings.

Specific Mitigation Measures for Installation of the RTO

All stacks associated with modifications of air pollution control system equipment shall be capped and sealed prior to removal of hermetic external seals, prior to restarting systems.

All stacks associated with air pollution control system modifications shall be thoroughly cleaned internally prior to removal of hermetic external seals, prior to restarting systems.

All materials removed will be washed with potable water prior to placement into a container for proper offsite disposal or recycling. The scrap will be placed into a rolloff container that is staged inside of the total enclosure building. Staging the rolloff container inside of the total enclosure building will minimize trips into and out of the building as well as minimize the possibility of dust being released into the environment that could be generated when placing materials into the rolloff container. The rolloff container will be covered when not in use and the exterior will be washed with potable water and tarped prior to removal to outside of any enclosure buildings.

j. Installation of HEPA Filters

Description of Construction:

Secondary High Efficiency Particulate Air (HEPA) filtration will be installed downstream of the MAC baghouses to reduce emissions of lead, arsenic and other metals. Following

these installations, all baghouses at the facility will have secondary filtration provided either by a wet scrubber or a HEPA filtration system.

This work will be completed within the total enclosure building which is under negative pressure with HEPA air filtration.

Specific Mitigation Measures:

All stacks associated with modifications of air pollution control system equipment shall be capped and sealed prior to removal of hermetic external seals, prior to restarting systems.

All stacks associated with air pollution control system modifications shall be thoroughly cleaned internally prior to removal of hermetic external seals, prior to restarting systems.

When the MAC baghouse units (C156/C157) are shut down for HEPA filter installation, no materials will be moved in the Reverb Feed Rooms (main or lower areas) and the existing feed material stockpiles will be covered with plastic. There will be no refinery kettle burner systems started.

All materials removed will be washed with potable water prior to placement into a container for proper offsite disposal or recycling. The scrap will be placed into a rolloff container that is staged inside of the total enclosure building. Staging the rolloff container inside of the total enclosure building will minimize trips into and out of the building as well as minimize the possibility of dust being released into the environment that could be generated when placing materials into the rolloff container. The rolloff container will be covered when not in use and the exterior will be washed with potable water and tarped prior to removal to outside of any enclosure buildings.

4. RCRA RFI Soil Sampling

Description:

The RCRA Facility Investigation (RFI) will require sampling/drilling through a known layer of contaminated soil and fill (typically 2 to 45 feet thick) that underlies the Exide property. Drilling techniques are expected to include direct push technology (i.e. Geoprobe), Rotasonic and hollow stem auger, and the specific technique for each location will be selected based on several factors, including; depth of required sampling, type of samples required and contaminants of concern. Geoprobe and Rotasonic drilling have little to no potential for generation of dust because both techniques allow advancement of the boring without the creation of cuttings and collect a continuous sample in a plastic sleeve. Hollow stem auger drilling techniques produce soil cuttings that travel up the auger and accumulate around the penetration at the ground surface. The cuttings are removed by the drill crew using a shovel and are placed in a container for disposal. The hollow stem auger cuttings created while drilling through the contaminated soil and fill have the potential to produce lead impacted dust. Because of the potential to generate lead impacted dust, on-site drilling performed using hollow stem auger techniques will be subject to additional mitigation measures as described below.

Specific Mitigation Measures:

The hollow stem auger drilling shall be completed within an enclosure. The enclosure will be created using a tent or fire resistant poly sheeting installed over a temporary structure. The enclosure will be operated under negative pressure and vented to a HEPA filtration control device. The enclosure will remain in place and operational for those activities that have the potential to generate airborne dust containing lead. The enclosure will be sized to ensure that drilling can be completed without extending outside of the enclosure, except for the drill mast that will extend through the top of the enclosure. A negative air system, equipped with HEPA filtration, will be installed to provide negative pressure in the enclosure. The negative air unit will be sized to provide a minimum of 4 complete air changes per hour based on the size of the enclosure and the opening that is required for the drill mast.

The ground surface will be covered with a layer of reinforced 10 mil plastic sheeting. The plastic sheet shall cover the entire ground surface that will be affected by the drilling activities and foot traffic within the enclosure. A second layer of plastic sheeting, extending at least 6 feet from the location of the boring shall be placed over the primary layer.

Potable water, using a pump up sprayer or similar spray device, will be used to wet the soil augered out of the hole if there is any dust being generated during the drilling process. Drill cuttings will be placed into containers with lids.

Each auger will be wrapped in plastic sheeting secured with heavy tape before removal from the enclosure. The augers will be transported to the total enclosure building for decontamination in the Corridor's decontamination area.

If the drill rig must remain in a hole overnight all cuttings must be containerized in a properly labeled, sealed 55-gal D.O T. drum. The plastic sheeting covering the ground surface shall be vacuumed using a vacuum equipped with a HEPA filter and the enclosure, including negative air system, shall be maintained. In addition, the upper layer of plastic sheeting around the boring penetration will be removed and replaced. The exposed auger will be wrapped with plastic. These precautions will minimize the chance for windblown dust to become airborne if the HEPA unit malfunctions during the night.

Upon completion of hollow stem auger drilling, the drill rig will be vacuumed, using a vacuum equipped with HEPA filtration, to remove dust and soil followed by ~~removal~~ vacuuming with HEPA filtration of the plastic sheeting on the ground surface after which it shall be removed. The negative air system will then be removed and the enclosure disassembled. The negative air system and enclosure will not be required during construction of monitoring wells (proposed well construction techniques will not generate cuttings or create lead contaminated dust).

No work will be performed when sustained winds exceed 20 MPH or instantaneous wind gusts exceed 25 MPH. No work will be performed if the negative air system is not operating.

5. **Other Plant Activities and Specific Mitigation Measures**

a. **Reverb Furnace Activities**

Description of Construction:

This project entails installing new brick in the reverb furnace within the smelter building which is in the total enclosure building. The total enclosure building must be under negative pressure with HEPA air filtration while work is conducted.

Specific Mitigation Measures:

The work area will be enclosed with fire resistant poly sheeting. A negative air system, equipped with HEPA filtration, will be installed to provide negative pressure in the work area. The negative air unit will be sized to provide a minimum of 4 complete air changes per hour based on the size of the enclosure. The work area will be vacuumed, using a vacuum equipped with HEPA filtration prior to the start of work and at a minimum at the end of each shift. More frequent cleaning using the HEPA vacuum will be performed if dust is present on the floors.

The new brick being installed does not contain lead. It will be cut to the proper size using a wet cut brick saw and potable water, which will minimize dust during the cutting process.

b. **Blast Furnace Activities**

Description of Construction:

This work entails installing a new crucible that has already been bricked in the blast furnace. The existing crucible will be relocated into the Corridor's decontamination area to remove the existing refractory brick.

This work will be completed within the total enclosure building, under negative pressure with HEPA air filtration.

Specific Mitigation Measures for Existing Crucible Refractory Removal

The existing crucible will be relocated into the Corridor's decontamination area for removal of the existing brick. The brick will be removed using wet demolition techniques, which will include pre wetting the refractory and applying a fine water mist onto the surface being demolished. The brick will be transferred into a rolloff container staged within the total enclosure building. Once the brick has been removed, the crucible will be cleaned by washing with potable water prior to storage for future refurbishment. The rolloff container will be covered when not in use and the exterior will be washed with potable water and tarped prior to removal to outside of any enclosure buildings.

c. Reverb A-Pipe Welding

Description of Construction:

Additional welding is required on the new A-Pipe to complete the structural integrity of the A-pipe.

Specific Mitigation Measures:

The areas to be welded will be cleaned by wiping with clean disposable wipes wet with a D-Lead Solution®. A wipe test will then be performed on the area to be welded using a Lead Wipe Test Kit (ESCA Tech Inc. Lead Test Kit). The test solution will be applied to the test kit supplied wipe. A wipe sample will be performed on 4 separate locations on each area to be welded using a new wipe wetted with the test solution. A yellow color indicates lead is present and additional cleaning is required. No color change indicates no lead is present. All 4 test locations must have a negative result prior to proceeding with the welding using standard welding techniques. The MSDS for the specific welding rod to be utilized will be reviewed. A welding rod will be utilized that does not contain lead. This process will be completed for each of the 4 areas that require additional welding. The welding will be completed immediately following the wipe testing.

d. Tank/Sump Repairs Tank 12 (Santa Maria Tank)

Description of Construction:

This project entails installing new steel walls for the tank and placing grout on the foundation.

This work will be completed within the total enclosure building which is under negative pressure with HEPA air filtration.

Specific Mitigation Measures:

The work area will be enclosed with fire resistant poly sheeting. A negative pressure air system equipped with HEPA filtration will be installed to provide negative air pressure on the enclosure. The negative air unit will be sized to provide a minimum of 4 complete air changes per hour based on the size of the enclosure.

The work area, including the floors adjacent to and around the tank and in front of the overhead door, will be vacuumed with a vacuum equipped with HEPA filtration prior to the start of work and at a minimum at the end of each shift. The north building door will remain closed except when needed to move items required for the repair that are too large to access this area by other access routes. Exide will provide an attendant to insure the large north building door is closed at all times except as described above. When use of this door is necessary, the attendant will stop the work, insure all other north facing doors are closed, open the door only enough to allow the material to be set inside the door and immediately close the door.

e. Tank/Sump Maintenance (Tank 24)

Description of Construction:

Additional fiberglass repair work is needed on the internal lining of Tank 24 (North Oxidation Tank). This tank is located outside. The work will be completed using confined space entry procedures. Confined space entry procedure includes continuous monitoring for oxygen, LEL and toxic gas and sufficient ventilation to provide a safe work environment.

Specific Mitigation Measures:

A negative pressure air system equipped with HEPA filtration will be installed to provide negative pressure on the tank. The top of the tank will be covered with a tarp that will be secured to the sides of the tank with a ratchet type strap. A small opening will be provided to allow a portion of the makeup air to enter the tank from the top. The negative pressure air system will be sized to provide a minimum of 4 complete air changes per hour. Entry into the tank will be through a side opening. A protective clothing change area will be established at the ingress/egress into the tank. The change area will consist of a small tent placed immediately adjacent to the tank. Poly sheeting will be installed between the tank and the tent to seal off any openings and provide positive ventilation thru the change area. Personnel entering the tank will don disposable clothing prior to entry into the tank and will remove the soiled protective clothing upon exit from the tank. Multiple layers of poly sheeting will be installed on the floor of the change area. The uppermost layer will be removed and bagged for disposal once personnel have removed their soiled disposable clothing. The soiled disposal clothing and plastic sheeting will be placed into a properly labeled container for offsite disposal. No work will be conducted on this tank when sustained outdoor winds exceed 12 MPH or instantaneous winds are 20 MPH or greater.

f. Storm Water Piping Project Completion/Restoration

Description of Repairs:

Several manholes in the plant have some minor concrete repairs needed around the covers. A few inches of the new concrete will be chipped off at the covers for the repairs.

Specific Mitigation Measures:

An enclosure will be constructed around the work site. A negative pressure air system equipped with HEPA filtration will be installed to provide negative pressure on the enclosure. The negative pressure air system will be sized to provide a minimum of 4 complete air changes per hour. The concrete chipping shall be performed using a Bosch Hammer Drill with Dust Collection System Model HDC-D1. The dust shroud will be attached to a vacuum equipped with HEPA filters with a minimum of 100 CFM of air flow.

The concrete being removed will be kept damp to prevent generation of dust during the concrete chipping. This will include using a pump type sprayer or similar device to provide a fine water mist applied directly to the hammer point. The water used during

the chipping shall be constantly removed using a HEPA filter equipped vacuum designed for the removal of liquids. The removed concrete shall be placed into a properly labeled container as they are removed. The containers shall remain in the enclosure and shall be covered when material is not being actively placed into the containers. All water used for chipping or other purposes shall be captured and treated properly to prevent a secondary means of fugitive emissions into the air.

All concrete or asphalt cutting/drilling performed outside total enclosure buildings shall be performed under 100% wet conditions and fully comply with the provisions of Rule 1420.1(i).

Grading of soil prior to pouring concrete or asphalt paving shall only be performed if soil surface that will be disturbed has at minimum 12% moisture content.

g. Refining Department Production Office Repairs

Description of Repairs:

Repairs are needed to the Smelting building's production office. This work is being completed in the total enclosure building that has negative air with filtration.

Specific Mitigation Measures:

This is standard indoor office repair work that does not impact any facility equipment, and has little to no fugitive emission risk. Any debris generated during the renovation will be placed into bags or wrapped with poly sheeting prior to removal from the office area. The work areas will be vacuumed prior to the start of work using vacuums equipped with HEPA filters and at a minimum once per day at the end of the shift. More frequent cleaning using the HEPA vacuum will be performed if dust is present on the floors.

h. RMPS Feed Room Sprinkler Installation

Description of Activity:

The ongoing sprinkler installation requires moving the feed piles to access the entire ceiling area. Exide will use loaders to relocate the feed stockpiles from one side of the room to the other side to provide access for the man lifts used to install the sprinkler system.

This work will be completed within the total enclosure building which is under negative pressure with air filtration.

Specific Mitigation Measures:

Normal procedures for moving the feed piles from one side of the room to the other will be followed. The loaders are already in the feed rooms and will not exit the building.

6. Other Maintenance and Specific Mitigation Measures

a. Security Surveillance Camera Installation

Description of Activity:

Security cameras need to be installed on the exterior walls of the building and on office roofs. This work entails mounting cameras by drilling small holes in walls/roofs to attach the cameras. All of the remaining locations require drilling thru steel.

Specific Mitigation Measures:

The drill used to drill the holes will be a Bosh Hammer Drill with Dust Collection System Model HDC-D1 or equivalent. The dust shroud will be attached to a vacuum equipped with HEPA filters with a minimum of 100 CFM of air flow. This high volume of air flow over this small area should provide the velocity required to remove the material removed by the drilling activities and transfer it to the drum vacuum.

b. Similar Plant and Maintenance Activities

Description of Activity:

Exide may conduct additional similar plant and maintenance activities to the extent the need for such work arises. Similar activities may include installation of replacement instruments, repair to building skin penetrations, and repairs to doors. Any such work will be coordinated with the AQMD Inspector, with reasonable advance notice. If the work is indoors, it will be completed within the total enclosure building which is under negative pressure with HEPA air filtration. Exide will also follow the General Measures described in this Mitigation Plan. To the extent specific mitigation plans are required for additional activities, Exide will work diligently to develop such plans in communication with AQMD and will submit the plans for AQMD's review and comments before beginning the work.

APPENDIX D

**PROPOSED REVISED CONSTRUCTION OF RISK REDUCTION
MEASURES, RCRA RFI SAMPLING, AND OTHER PLANT
ACTIVITIES, AUGUST 2014**

MITIGATION PLAN
For
CONSTRUCTION of RISK REDUCTION MEASURES,
RCRA RFI SAMPLING,
AND OTHER PLANT ACTIVITIES

Prepared For:
Exide Technologies
2700 Indiana Street
Vernon, CA 90058

Prepared by:
Remediation Services, Inc.
Independence, KS

August 8, 2014

TABLE OF CONTENTS

	<u>Page No.</u>
1. Introduction.....	1
2. General Measures to Be Undertaken During Implementation of the Risk Reduction Construction, Maintenance Activities, RCRA RFI Activities and Other Plant Activities	1
a. Dust Removal.....	2
b. Continuous Air Monitoring.....	3
c. Damper Installation	4
d. Installation of High Speed Doors.....	4
e. Controlled Access to North Overhead Door.....	4
f. Decontamination Areas	4
g. Facility Trash and Debris	5
h. Drilling, Pavement Removal and Soil Activities	5
i. Third Party Oversight Consultant.....	5
3. Risk Reduction Activities and Specific Mitigation Measures.....	6
a. Blast Furnace Tray Type Wet Scrubbing System Installation.....	6
b. Hard Lead Ventilation System Modification	8
c. Installation of Blast Furnace Partial Enclosure	9
d. Installation of Blast Furnace Charge Level Sensor.....	10
e. Installation of Blast Furnace Temperature Sensor.....	10
f. Blast Furnace Ventilation Hood Modification	10
g. Reverb Furnace Feed Modification	11
h. Refining Kettle Ventilation Hood Modification	12
i. Installation of Reverb Dryer Regenerative Thermal Oxidizer	12
j. Installation of HEPA Filters	13
k. Installation of Blast Furnace Regenerative Thermal Oxidizer and Cartridge Filter Baghouse	14
4. RCRA RFI Soil Sampling	15
5. Other Plant Activities and Specific Mitigation Measures.....	16
a. Reverb Furnace Activities	16
b. Blast Furnace Activities	17
c. Reverb A-Pipe Welding.....	17
d. Tank/Sump Repairs Tank 12 (Santa Maria Tank)	18
e. Tank/Sump Maintenance (Tank 24).....	18
f. Storm Water Piping Project Completion/Restoration	19
g. Refining Department Production Office Repairs	20
h. RMPS Feed Room Sprinkler Installation	20
6. Other Maintenance and Specific Mitigation Measures	20
a. Security Surveillance Camera Installation	20
b. Similar Plant and Maintenance Activities	21

1. Introduction

Remediation Services, Inc. (RSI) has prepared this Site Mitigation Plan to identify the measures that will be taken to monitor and minimize fugitive emissions of lead and other toxic metals associated with planned maintenance activities, RCRA RFI sampling activities, and facility modifications being conducted pursuant to the Final Risk Reduction Plan at Exide Technologies' Vernon Recycling Center. The goal of this plan is to exceed standard South Coast Air Quality Management District (SCAQMD) requirements pertaining to dust and emission controls to prevent emissions of lead and other toxic metals during those construction and maintenance activities. RSI anticipates that Exide Technologies (Exide's) mitigation activities at the Vernon facility will be coordinated with and overseen by a third party consultant retained by the SCAQMD. The name and qualifications of the third party consultant will be provided to AQMD 2 business days in advance of hiring the third party consultant.

As described below, Exide will implement general measures to minimize emissions during implementation of the Risk Reduction Construction activity, all maintenance activities, Other Plant Activities and the RCRA RFI sampling activities. In addition, Exide and the SCAQMD's third party consultant will track the status of specific risk reduction activities that have been approved by the SCAQMD. Exide will implement the specific mitigation measures described in detail below during each respective step of the risk reduction construction, maintenance work and RCRA RFI sampling activities.

2. General Measures to Be Undertaken During Implementation of the Risk Reduction Construction, Maintenance Activities, RCRA RFI Activities and Other Plant Activities

Exide will undertake these General Measures during the entirety of performing the activities set forth herein.

Any and all maintenance activity(ies) as defined in SCAQMD Rule 1420.1(c)(17) shall be conducted in accordance with the requirements of Rule 1420.1(i) Maintenance Activity.

Total containment buildings shall be maintained under negative pressure and vented to HEPA filtration when electrical system modifications and maintenance work is performed the use of rented temporary electrical power generators.

Large piles of material such as slag, battery scrap or other lead containing material shall not be kept near the high-speed doors to prevent the release of fugitive emissions through the rollup doors when open.

Any maintenance or repair work, conducted on the facility's premises, to a HEPA vacuum, sweeper, or negative air machine shall only be performed inside of a total enclosure building maintained under negative pressure and vented to permitted air pollution control systems.

The established plant speed limit of 5 mph as required by the Basic Safety Orientation Form HS002, Rev 3.19.2014 shall be required of every Employee, Contractor and Visitor.

The maximum speed limit of no greater than 10 mph for vehicles on-site transporting material from inside an enclosure to areas outside an enclosure and no greater than 20 mph for any other vehicle on-site of the facility.

During all RCRA RFI sampling activities and maintenance activities the plant grounds shall be swept at least twice per shift using a mobile HEPA sweeper. Records of the sweeping shall be kept and made available to SCAQMD staff, upon request.

During the RCRA RFI sampling and all maintenance activities if at any time any of the six fence-line monitors obtain laboratory results showing a daily Excursion of lead greater than 0.15 ug/m³, Exide of their Contractors shall stop all RFI sampling and maintenance activities, and submit further mitigation measures to the SCAMD for review and approval.

During the RCRA RFI sampling and all maintenance activities Exide shall designate an environmental staff person whose responsibility shall be to assure ongoing and sustained compliance with all applicable SCAQMD Rules and Regulations. This environmental designee shall be trained and knowledgeable of R1420.1 and R1420 and be empowered to expeditiously employ sufficient mitigation measures and stop work to gain facility compliance.

Downwind monitoring with TSI DustTraks (Dust Traks) should also be performed for all RCRA RFI maintenance/construction/demolition activities (activities) conducted outside of an enclosure building (including any activities conducted in a portable enclosure even if vented to HEPAs). The number of DustTraks utilized downwind should be in proportion to the degree of wind direction variance with one unit for each 30 degrees of wind direction variance. The values should be recorded every 15 minutes. As observing personnel note potentially adverse dust evolution using these devices in conjunction with visual observation and experience, they shall direct work stoppage and then direct adjustments in the work practices and/or the applied control measures as appropriate. In response to adverse visual observations or DustTrak results the mitigation measures as discussed in the Mitigation Plan shall be implemented. Records of DustTrak monitors, including time and locations, shall be recorded and kept on site and made available upon request by SCAQMD staff.

a. Dust Removal

Prior to the start of construction on any of the risk reduction equipment or Other Plant Activities within any total enclosure buildings, accumulated dust that may contain lead or other toxic metals will be removed from horizontal surfaces, such as building columns, upper rafters and supports, and from equipment that will be modified during the construction activities. This dust will be recycled through the existing dust conveyance, which converts the dust into water slurry. That slurry will then be sent to the filter press circuit. This dust removal process will be completed using wet wash down methods and/or High Efficiency Particulate Air equipped vacuums.

b. Continuous Air Monitoring

The third party oversight contractor will utilize hand-held continuous particulate aerosol monitors (TSI DustTrak or equivalent) which work on the principle of optical scatter from aerosols both inside and outside the enclosures during all risk reduction construction and maintenance activities. Such devices were utilized by the contractors and Exide oversight personnel during the recent storm water piping replacement effort. As may be relevant to the particular work aspect at hand, these devices will be deployed on a stand downwind and potentially upwind of a work function to track and gauge the trending in particulate dust generation during work progress. Each Dust Trak Unit will cover 30° of wind direction change. An appropriate number of Dust Trak units will be deployed for each project depending on the wind direction and location of the work. When the wind direction is outside the capture zone of at least one Dust Trak unit the work will be stopped until the Dust Trak unit(s) can be relocated. As observing personnel note potentially adverse dust evolution using these devices in conjunction with visual observation and experience, they shall direct work stoppage and then direct adjustments in the work practices and/or the applied control measures as appropriate. In response to adverse visual observations or DustTrak results the mitigation measures as discussed in the Mitigation Plan shall be implemented.

In response to adverse visual observations or DustTrak results Exide ~~will, as necessary,~~ shall implement the following increased dust suppression activities. These increased dust suppression abatement activities will include, but are not limited to the following:

- Stop all work outside of any total enclosure building that has the potential to generate lead or other toxic metals containing dust. Negative air filtration units installed on enclosures will remain in operation for the duration of the stop work order. Equipment that was being used inside of the total enclosure building shall remain in place during the stop work period.
- Immediately begin application of water on all paved areas.
- Stop all onsite vehicle traffic outside of the all total enclosure building.
- All overhead doors on any total enclosure building are to remain closed.
- Determine if there are any activities within any total enclosure building that could be contributing to the increase in dust concentration. If so stop that activity.
- Determine if there are any offsite activities that are being conducted by others that are contributing to the increase in dust concentration. If so, suspend all activities outside of total enclosure building that have the potential to generate lead and other toxic metals containing dust until additional dust mitigation has been implemented or the activity completed and the areas both on-site and off-site are cleaned.

The abatement activities described above will remain in effect until Exide and the third party consultant determine the cause of the adverse readings and additional dust mitigation for the activity that caused the increase in dust concentration has been implemented.

If the cause of the adverse DustTrak readings cannot be attributed to any one activity outside of total enclosure buildings and no activity within any total enclosure building, the work outside of the total enclosure building will be restarted on a rolling basis with the activity that would be expected to generate

the least amount of lead containing dust starting first. No work may resume until DustTrak readings show that the adverse dust condition does not exist anymore.

The real time data from the DustTraks will be continuously monitored during this rolling start to determine if there is an increase in the dust concentrations following the restart of any one activity. If an increase is noted after restarting any activity, that activity will be stopped until additional dust suppression measures have been implemented. The rolling start activities following the activity that caused the increase in dust consideration may be restarted using the basis described above with continuous monitoring of the real time particulate data to insure none of the follow on activities causes an increase in the total particulate concentration. If after work resumes, DustTrak readings show adverse dust conditions, the dust suppression and abatement activity described above shall be implemented. All dust measurements obtained by DustTraks during the activities described in this Mitigation Plan must be maintained in an electronic format and be made available to SCAQMD staff upon request.

c. Damper Installation

Manual dampers will be installed on the makeup air inlet louvers of the baghouse row total enclosure building to close and prevent the escape of particulates in order to enhance emission control.

d. Installation of High Speed Doors

High speed doors will be installed on the two overhead doors, one on the north end of the baghouse building and one on the south end of the Corridor. To minimize the potential for loss of negative pressure during installation of the doors, temporary total enclosures will be installed on the exterior of the door prior to removal of the existing door. The temporary total enclosures will be constructed by installing a frame covered with heavy fire resistant reinforced plastic sheeting that is fastened to the building skin. No activities shall be conducted in the baghouse building or corridor from the time the existing doors are removed until the new high-speed doors are installed.

e. Controlled Access to North Overhead Door

Use of the north overhead door in the baghouse building will be minimized and access controlled to minimize emissions from the baghouse building.

f. Decontamination Areas

Each overhead door location will be equipped with potable water to be used to decontaminate any materials and equipment prior to transfer outside of the total enclosure buildings. The overhead door will remain closed during all decontamination activities to prevent the release of contaminated overspray out of the building. The decontamination area floor will be cleaned prior to removal of the piece of equipment to ensure lead residue is not transferred outside of the total enclosure building.

g. Facility Trash and Debris

All facility trash and debris designated for offsite disposal will be placed in covered containers prior to transfer to the rolloff container. The rolloff container will be covered when materials are not being actively placed into it. The exterior of the rolloff container will be taken to the decontamination area in the Corridor and cleaned with potable water prior to removal from the plant.

Roll-off Containers that are to be used to transport scrap metal, concrete, soil, or any construction or demolition debris shall be totally contained where no dust or liquid leaking is allowed during transport.

h. Drilling, Pavement Removal and Soil Activities

All concrete or asphalt cutting/drilling performed outside total enclosure buildings shall be performed under 100% wet conditions and fully comply with the provisions of Rule 1420.1(i).

Grading of soils prior to pouring concrete or asphalt paving shall only be performed if soil surface that will be disturbed has at minimum 12% moisture content

Any soil grading/leveling project which has the potential to generate any dust whatsoever shall be performed under temporary negative pressure enclosures maintained through the use of permitted HEPA negative air machines. Apply water or a stabilizing agent in sufficient quantities to prevent the generation of visible dust plumes when the work area is not immediately to be covered by concrete, asphalt, paving material, etc.

The liquid run off from areas that are wetted shall be contained or directed into drains so as not to allow the liquid run off to evaporate and cause a secondary means of dust to be entrained into the air.

Any drilling, pavement removal and soil disturbing activities outside of the total enclosure buildings will be performed only when sustained wind velocities are less than 12 MPH and instantaneous gusts are less than 20 mph, which is more stringent than required by South Coast Air Quality Management District (AQMD) Rule 1420.1. Any work of this type on Exide's property will be completed in an enclosure with negative air and HEPA filtration.

i. Third Party Oversight Consultant

SCAQMD will contract with a third party consultant to oversee and document the mitigation activities performed during the maintenance, RFI sampling, and risk reduction activities described below, and will provide weekly reports to the District and Exide regarding the Mitigation Plan activities and progress on Friday of each week. Reports shall include activities conducted up to 24 hours following implementation of mitigation activities.

The following are the specific additional mitigation measures planned for the various activities being undertaken.

3. Risk Reduction Activities and Specific Mitigation Measures

a. Blast Furnace Tray Type Wet Scrubbing System Installation

Description of Construction:

A new venturi and tray type wet scrubbing system will be installed to serve the main air pollution control system (APCS) function for the blast furnace, removing this load from the existing Neptune scrubbing system. The new system will be moved into the plant using forklifts using an existing overhead door. The existing Neptune scrubber will continue in service for the reverberatory furnace. Installation of this second wet scrubbing system will allow the primary process draft to each furnace to be managed independently to reduce emissions and maintain appropriate pressure in both furnaces pursuant to amended AQMD Rule 1420.1. This modification will also reduce emissions of metal and organic constituents as limited in amended AQMD Rule 1420.1. Both scrubbers (existing and new) will discharge to a new, larger single stack.

The majority of the work will be completed within the total enclosure building with negative pressure and HEPA air filtration. The work will include the removal and replacement of the existing stack and stack support structure which extends through the roof. The work will include the removal of the existing floor and limited amounts of soil to allow installation of new concrete foundations. Any work conducted outside the enclosure buildings will be subject to the mitigation measures listed under Section 2 of this document.

Specific Mitigation Measures for Foundation Installation:

Prior to removal of the existing floor and underlying soil to allow installation of the foundations for the new scrubber system, the existing floor will be thoroughly cleaned using HEPA vacuums followed by washing with potable water. The construction contractor will saw the concrete using wet methods to minimize generation of dust. The concrete being removed will be kept damp to minimize the generation of dust during the concrete demolition and removal activities. Additional dust control will include applying a fine water mist directly on the demolition hammer point during the demolition activities. A fine water mist will also be applied to the concrete and soil as it is being excavated to minimize the generation of dust.

Concrete and soil will be transferred into a rolloff container that is staged inside of the total enclosure building, which will minimize trips into and out of the building and minimize the possibility of any dust generated by placing the concrete and soil into the container being released into the environment. The rolloff container will be covered when not in use and the exterior will be washed with potable water and tarped prior to removal to outside any enclosure buildings.

Specific Mitigation Measures for Removal and Replacement of the Existing Stack and Stack Support System

A scaffold system will be installed on the roof to provide a means to construct a total enclosure around the existing Neptune Scrubber stack and associated stack support structure prior to their removal. The scaffold will be totally enclosed using reinforced fire resistant poly sheeting. The enclosure around the Neptune Scrubber stack and scaffold will be operated under negative pressure and vented to a HEPA filtration control device. The roof in the area of the scaffolding will be cleaned using HEPA vacuums and washed prior to installation of the scaffolding. The underside of the roof and roof support system will be cleaned to remove accumulated dust using HEPA vacuums. The underside of the roof will be washed promptly after the enclosure on the roof has been installed. All water used for washing the roof areas shall be captured and treated properly to prevent a secondary means of fugitive emissions into the air.

Once the exterior scaffold has been erected and enclosed, the structure that supports the existing Neptune Scrubber stack will also be wrapped with fire resistant poly sheeting to provide secondary protection. The installation of the secondary enclosure will be completed by accessing the pipe support structure from inside of the building.

A crane will be used to lower the existing Neptune Scrubber stack and support structure into the building. A small hole, approximately 1 foot in diameter, will be cut in the top of the temporary enclosure to allow the crane rigging to be attached to the stack and support structure. The existing Neptune Scrubber stack and support structure will then be lowered into the total enclosure building for dismantling. Each section will be removed as it is cut away from the sections above using forklifts or cranes working inside of the total enclosure building.

Because some modifications to the roof and roof support system will be required to allow installation of the new stack and support system, the inside of the roof and roof support structure will be inspected and re-cleaned prior to beginning the modifications. This work will be completed with the temporary enclosure in place, and Exide and the third party consultant will ensure that there is sufficient inward air velocity through any openings (minimum 300 fpm measured at the opening using a handheld anemometer) to prevent dust that is generated during the work from migrating into the temporary enclosure constructed on the roof.

The new stack and support structure will be lowered into the building using a crane. A hole, large enough to allow placement of the equipment through the temporary structure, will be cut in the top of the plastic enclosure immediately prior to the installation. Once the structure has been lowered into place, the top of the temporary structure will be replaced to minimize the size of the opening to only what is required for the crane rigging.

After the new stack and structure have been installed, the roof will be repaired from within the containment structure. If access into the temporary structure is required from the roof, an airlock-type temporary door with at least 300 fpm draft, verified using a handheld anemometer, will be constructed to provide access into and out of the temporary enclosure.

Once the work is complete, the roof and interior of the temporary structure will be cleaned using HEPA equipped vacuums to remove any dust prior to removal. A wipe test will then be performed on each side and the top of the enclosure as well as the floor (top of the roof) using a Lead Wipe Test Kit (ESCA Tech Inc. Lead Test Kit). A yellow color indicates lead is present and additional cleaning is required. The additional cleaning will consist of wet wiping using a D-lead solution. No color change indicates no lead is present. All 5 test locations must have a negative result prior to proceeding with dismantlement.

b. Hard Lead Ventilation System Modification

Description of Construction:

Ventilation hoods now connected to the Hard Lead Ventilation System serving the charging area at the top of the blast furnace will be redirected to the inlet side of an enhanced afterburner so that those gases will be directed through the main APCS train serving the blast furnace, including the afterburner and subsequent new wet scrubber.

This work will be completed within the total enclosure building under negative pressure with HEPA air filtration.

Specific Mitigation Measures:

All stacks associated with modifications of air pollution control system equipment shall be capped and sealed prior to removal of hermetic external seals, prior to restarting systems.

All stacks associated with air pollution control system modifications shall be thoroughly cleaned internally prior to removal of hermetic external seals, prior to restarting systems.

During any welding or torching on the ventilation system, the baghouse will be shut down until the welding or torch work is complete. If the work is on a vent duct that is not on the main ventilation run, then that specific vent duct will be blanked off of the main duct while the baghouse continues to operate, if flanges are already installed to allow for the blank. If welding or torch work is needed when the vent duct leg is ready to be put back into service, the baghouse will be shut down for the required time and then restarted.

Spark arrestors or equivalent precautions shall be employed when hot work will be vented to dry filter media.

All materials removed will be washed with potable water prior to placement into a container for proper offsite disposal or recycling. The scrap will be placed into a rolloff container that is staged inside of the total enclosure building. Staging the rolloff container inside of the total enclosure building will minimize trips into and out of the building as well as minimize the possibility of dust being released into the environment that could be generated when placing materials into the rolloff container. The rolloff container will be covered when not in use and the exterior will be washed with potable water and tarped prior to removal to outside of any enclosure buildings.

All pipe/duct/other materials which are too large for the scrap rollofs shall be cut down to shipping sized, washed with potable water, and hermetically sealed prior to removal from the total enclosure buildings, and prior to placement on vehicles for export outside of facility.

c. Installation of Blast Furnace Partial Enclosure

Description of Construction:

A new enclosure within the overall blast furnace partial enclosure will be installed around the furnace charge area to serve as a secondary hood to enhance capture of gases escaping the charge isolation door by the hoods at the top of this enclosure. The current partial enclosure in which the blast furnace resides will be enhanced with sealed siding and close-fitting doors.

This work will be completed within the total enclosure building under negative pressure with HEPA air filtration.

Specific Mitigation Measures:

All stacks associated with modifications of air pollution control system equipment shall be capped and sealed prior to removal of hermetic external seals, prior to restarting systems.

All stacks associated with air pollution control system modifications shall be thoroughly cleaned internally prior to removal of hermetic external seals, prior to restarting systems.

During any welding or torching on the ventilation system, the baghouse will be shut down until the welding or torch work is complete. If the work is on a vent duct that is not on the main ventilation run, then that specific vent duct will be blanked off of the main duct while the baghouse continues to operate, if flanges are already installed to allow for the blank. If welding or torch work is needed when the vent duct leg is ready to be put back into service, the baghouse will be shut down for the required time and then restarted.

Spark arrestors or equivalent precautions shall be employed when hot work will be vented to dry filter media.

All materials removed will be washed with potable water prior to placement into a container for proper offsite disposal or recycling. The scrap will be placed into a rolloff container that is staged inside of the total enclosure building. Staging the rolloff container inside of the total enclosure building will minimize trips into and out of the building as well as minimize the possibility of dust being released into the environment that could be generated when placing materials into the rolloff container. The rolloff container will be covered when not in use and the exterior will be washed with potable water and tarped prior to removal to outside of any enclosure buildings.

d. Installation of Blast Furnace Charge Level Sensor

Description of Construction:

A radar-based charge level sensor will be installed within the blast furnace in order to provide operators with ongoing data regarding the level of the feed burden within the furnace. The work includes installation of the sensor and instrument cables from the blast furnace to the control room and power to the device.

This work will be completed within the total enclosure building under negative pressure with HEPA air filtration.

Specific Mitigation Measures:

The sensor installation holes have been completed. The remaining work to insert the probes, run cabling and make the connections will not require any mitigation measures.

e. Installation of Blast Furnace Temperature Sensor

Description of Construction:

A temperature sensor will be installed within the top of the blast furnace as an additional operational indicator of charge level. The work includes installation of the sensor and instrument cables from the blast furnace to the control room and power to the device.

This work will be completed within the total enclosure building under negative pressure with HEPA air filtration.

Specific Mitigation Measures:

The sensor installation holes have been completed. The remaining work to insert the probes, run cabling and make the connections will not require any mitigation measures.

f. Blast Furnace Ventilation Hood Modification

Description:

The ventilation hood now connected to the Hard Lead Ventilation System serving the slag tap of the blast furnace will be enlarged and then it will be served with greater air flow. This air will be redirected to the new Blast Furnace #2 baghouse that will be routed to the new wet scrubbing system.

This work will be completed within the total enclosure building under negative pressure with HEPA air filtration.

Specific Mitigation Measures:

All stacks associated with modifications of air pollution control system equipment shall be capped and sealed prior to removal of hermetic external seals, prior to restarting systems.

All stacks associated with air pollution control system modifications shall be thoroughly cleaned internally prior to removal of hermetic external seals, prior to restarting systems.

During any welding or torching on the ventilation system, the baghouse will be shut down until the welding or torch work is complete. If the work is on a vent duct that is not on the main ventilation run, then that specific vent duct will be blanked off of the main duct while the baghouse continues to operate, if flanges are already installed to allow for the blank. If welding or torch work is needed when the vent duct leg is ready to be put back into service, the baghouse will be shut down for the required time and then restarted.

Spark arrestors or equivalent precautions shall be employed when hot work will be vented to dry filter media.

All materials removed will be washed with potable water prior to placement into a container for proper offsite disposal or recycling. The scrap will be placed into a rolloff container that is staged inside of the total enclosure building. Staging the rolloff container inside of the total enclosure building will minimize trips into and out of the building as well as minimize the possibility of dust being released into the environment that could be generated when placing materials into the rolloff container. The rolloff container will be covered when not in use and the exterior will be washed with potable water and tarped prior to removal to outside of any enclosure buildings.

g. Reverb Furnace Feed Modification

Description of Construction:

The existing ram feeding mechanisms on the reverberatory furnace will be replaced with screw feeders to reduce the potential for organic-bearing process gases to be drawn into the Soft Lead Ventilation System pickup hooding when the ram feeders cycle.

This work will be completed within the total enclosure building under negative pressure with HEPA air filtration.

Specific Mitigation Measures:

The ram feeders will be washed with potable water prior to cutting into manageable pieces for offsite recycling. The scrap will be placed into a rolloff container that is staged inside of the total enclosure building. Staging the rolloff container inside of the total enclosure building will minimize trips into and out of the building as well as minimize the possibility of dust being released into the environment that could be generated when placing materials into the rolloff container. The rolloff container will be covered when not in use and the exterior will be washed with potable water and tarped prior to removal to outside of any enclosure buildings.

h. Refining Kettle Ventilation Hood Modification

Description of Construction:

The ventilation ducting serving two refining kettles will be removed from the Hard Lead Ventilation System and redirected to the new Blast Furnace #2 baghouse that will be routed to the new wet scrubbing system. In the future, arsenic additions in refining operations will be restricted to these two kettles.

This work will be completed within the total enclosure building which is under negative pressure with HEPA air filtration.

Specific Mitigation Measures:

All stacks associated with modifications of air pollution control system equipment shall be capped and sealed prior to removal of hermetic external seals, prior to restarting systems.

All stacks associated with air pollution control system modifications shall be thoroughly cleaned internally prior to removal of hermetic external seals, prior to restarting systems.

During any welding or torching on the ventilation system, the baghouse will be shut down until the welding or torch work is complete. If the work is on a vent duct that is not on the main ventilation run, then that specific vent duct will be blanked off of the main duct while the baghouse continues to operate, if flanges are already installed to allow for the blank. If welding or torch work is needed when the vent duct leg is ready to be put back into service, the baghouse will be shut down for the required time and then restarted.

Spark arrestors or equivalent precautions shall be employed when hot work will be vented to dry filter media.

All materials removed will be washed with potable water prior to placement into a container for proper offsite disposal or recycling. The scrap will be placed into a rolloff container that is staged inside of the total enclosure building. Staging the rolloff container inside of the total enclosure building will minimize trips into and out of the building as well as minimize the possibility of dust being released into the environment that could be generated when placing materials into the rolloff container. The rolloff container will be covered when not in use and the exterior will be washed with potable water and tarped prior to removal to outside of any enclosure buildings.

i. Installation of Reverb Dryer Regenerative Thermal Oxidizer

Description of Construction:

A regenerative thermal oxidizer (RTO) will be installed on the reverberatory furnace feed dryer exhaust to reduce emissions of organic gases. The work will include the removal of the existing floor and limited amounts of soil to allow installation of concrete foundations. The concrete joints will be sealed by installing Sonolastic ® SL1™ or equivalent.

This work will be completed within the total enclosure building under negative pressure with HEPA air filtration.

Specific Mitigation Measures for Concrete and Soil Removal:

Prior to removal of the existing floor and underlying soil to allow installation of the foundations for the new RTO, the existing floor will be thoroughly cleaned using HEPA vacuums followed by washing with potable water. The construction contractor will saw the concrete using wet methods to minimize generation of dust. The concrete being removed will be kept damp to minimize the generation of dust during the concrete demolition and removal activities. Additional dust control will include applying a fine water mist directly on the demolition hammer point during the demolition activities. A fine water mist will also be applied to the concrete and soil as it is being excavated to minimize the generation of dust. All water used for washing the floor and for other uses shall be captured and treated properly to prevent a secondary means of fugitive emissions into the air.

Concrete and soil will be transferred into a rolloff container that is staged inside of the total enclosure building, for proper off-site disposal or recycling which will minimize trips into and out of the building and eliminate the possibility of any dust generated during placement of the concrete and soil into the container being released into the environment. The rolloff container will be covered when not in use and the exterior will be washed with potable water and tarped prior to removal to outside of any enclosure buildings.

Specific Mitigation Measures for Installation of the RTO

All stacks associated with modifications of air pollution control system equipment shall be capped and sealed prior to removal of hermetic external seals, prior to restarting systems.

All stacks associated with air pollution control system modifications shall be thoroughly cleaned internally prior to removal of hermetic external seals, prior to restarting systems.

All materials removed will be washed with potable water prior to placement into a container for proper offsite disposal or recycling. The scrap will be placed into a rolloff container that is staged inside of the total enclosure building. Staging the rolloff container inside of the total enclosure building will minimize trips into and out of the building as well as minimize the possibility of dust being released into the environment that could be generated when placing materials into the rolloff container. The rolloff container will be covered when not in use and the exterior will be washed with potable water and tarped prior to removal to outside of any enclosure buildings.

j. Installation of HEPA Filters

Description of Construction:

Secondary High Efficiency Particulate Air (HEPA) filtration will be installed downstream of the MAC baghouses to reduce emissions of lead, arsenic and other metals. Following these installations, all baghouses at the facility will have secondary filtration provided either by a wet scrubber or a HEPA filtration system.

This work will be completed within the total enclosure building under negative pressure with HEPA air filtration.

Specific Mitigation Measures:

All stacks associated with modifications of air pollution control system equipment shall be capped and sealed prior to removal of hermetic external seals, prior to restarting systems.

All stacks associated with air pollution control system modifications shall be thoroughly cleaned internally prior to removal of hermetic external seals, prior to restarting systems.

When the MAC baghouse units (C156/C157) are shut down for HEPA filter installation, no materials will be moved in the Reverb Feed Rooms (main or lower areas) and the existing feed material stockpiles will be covered with plastic. There will be no refinery kettle burner systems started.

All materials removed will be washed with potable water prior to placement into a container for proper offsite disposal or recycling. The scrap will be placed into a rolloff container that is staged inside of the total enclosure building. Staging the rolloff container inside of the total enclosure building will minimize trips into and out of the building as well as minimize the possibility of dust being released into the environment that could be generated when placing materials into the rolloff container. The rolloff container will be covered when not in use and the exterior will be washed with potable water and tarped prior to removal to outside of any enclosure buildings.

k. Installation of Blast Furnace Regenerative Thermal Oxidizer and Cartridge Filter Baghouse

Description of Construction:

A regenerative thermal oxidizer (RTO) and cartridge filter baghouse will be installed on the blast furnace charge floor ventilation systems to reduce emissions of organic gases. The work will include the removal of the existing floor and limited amounts of soil to allow installation of concrete foundations. The concrete joints will be sealed by installing Sonolastic® SL1™ or equivalent.

This work will be completed within the total enclosure building under negative pressure with HEPA air filtration.

Specific Mitigation Measures for Concrete and Soil Removal:

Prior to removal of the existing floor and underlying soil to allow installation of the foundations for the new RTO and baghouse, the existing floor will be thoroughly cleaned using HEPA vacuums followed by washing with potable water. The construction contractor will saw the concrete using wet methods to minimize generation of dust. The concrete being removed will be kept damp to minimize the generation of dust during the concrete demolition and removal activities. Additional dust control will include applying a fine water mist directly on the demolition hammer point during the demolition activities. A fine water mist will also be applied to the concrete and soil as it is being excavated to minimize the generation of dust. All water used for washing the floor and for other uses

shall be captured and treated properly to prevent a secondary means of fugitive emissions into the air.

Concrete and soil will be transferred into a rolloff container that is staged inside of the total enclosure building, for proper off-site disposal or recycling which will minimize trips into and out of the building and eliminate the possibility of any dust generated during placement of the concrete and soil into the container being released into the environment. The rolloff container will be covered when not in use and the exterior will be washed with potable water and tarped prior to removal to outside of any enclosure buildings.

Specific Mitigation Measures for Installation of the RTO and cartridge filter baghouse

All materials removed will be washed with potable water prior to placement into a container for proper offsite disposal or recycling. The scrap will be placed into a rolloff container that is staged inside of the total enclosure building. Staging the rolloff container inside of the total enclosure building will minimize trips into and out of the building as well as minimize the possibility of dust being released into the environment that could be generated when placing materials into the rolloff container. The rolloff container will be covered when not in use and the exterior will be washed with potable water and tarped prior to removal to outside of any enclosure buildings.

4. RCRA RFI Soil Sampling

Description:

The RCRA Facility Investigation (RFI) will require sampling/drilling through a known layer of contaminated soil and fill (typically 2 to 45 feet thick) that underlies the Exide property. Drilling techniques are expected to include direct push technology (i.e. Geoprobe), Rotosonic and hollow stem auger, and the specific technique for each location will be selected based on several factors, including; depth of required sampling, type of samples required and contaminants of concern. Geoprobe and Rotosonic drilling have little to no potential for generation of dust because both techniques allow advancement of the boring without the creation of cuttings and collect a continuous sample in a plastic sleeve. Hollow stem auger drilling techniques produce soil cuttings that travel up the auger and accumulate around the penetration at the ground surface. The cuttings are removed by the drill crew using a shovel and are placed in a container for disposal. The hollow stem auger cuttings created while drilling through the contaminated soil and fill have the potential to produce lead impacted dust. Because of the potential to generate lead impacted dust, on-site drilling performed using hollow stem auger techniques will be subject to additional mitigation measures as described below.

Specific Mitigation Measures:

The hollow stem auger drilling shall be completed within an enclosure. The enclosure will be created using a tent or fire resistant poly sheeting installed over a temporary structure. The enclosure will be operated under negative pressure and vented to a HEPA filtration control device. The enclosure will remain in place and operational for those activities that have the potential to generate airborne dust containing lead. The enclosure will be sized to ensure that drilling can be completed without extending outside of the enclosure, except for the drill mast that will extend through the top of the

enclosure. A negative air system, equipped with HEPA filtration, will be installed to provide negative pressure in the enclosure. The negative air unit will be sized to provide a minimum of 4 complete air changes per hour based on the size of the enclosure and the opening that is required for the drill mast.

The ground surface will be covered with a layer of reinforced 10 mil plastic sheeting. The plastic sheet shall cover the entire ground surface that will be affected by the drilling activities and foot traffic within the enclosure. A second layer of plastic sheeting, extending at least 6 feet from the location of the boring shall be placed over the primary layer.

Potable water, using a pump up sprayer or similar spray device, will be used to wet the soil augered out of the hole if there is any dust being generated during the drilling process. Drill cuttings will be placed into containers with lids.

Each auger will be wrapped in plastic sheeting secured with heavy tape before removal from the enclosure. The augers will be transported to the total enclosure building for decontamination in the Corridor's decontamination area.

If the drill rig must remain in a hole overnight all cuttings must be containerized in a properly labeled, sealed 55-gal D.O T. drum. The plastic sheeting covering the ground surface shall be vacuumed using a vacuum equipped with a HEPA filter and the enclosure, including negative air system, shall be maintained. In addition, the upper layer of plastic sheeting around the boring penetration will be removed and replaced. The exposed auger will be wrapped with plastic. These precautions will minimize the chance for windblown dust to become airborne if the HEPA unit malfunctions during the night.

Upon completion of hollow stem auger drilling, the drill rig will be vacuumed, using a vacuum equipped with HEPA filtration, to remove dust and soil followed by vacuuming with HEPA filtration of the plastic sheeting on the ground surface after which it shall be removed. The negative air system will then be removed and the enclosure disassembled. The negative air system and enclosure will not be required during construction of monitoring wells (proposed well construction techniques will not generate cuttings or create lead contaminated dust).

No work will be performed when sustained winds exceed 12 MPH or instantaneous wind gusts exceed 20 MPH. No work will be performed if the negative air system is not operating.

5. Other Plant Activities and Specific Mitigation Measures

a. Reverb Furnace Activities

Description of Construction:

This project entails installing new brick in the reverb furnace within the smelter building which is in the total enclosure building. The total enclosure building must be under negative pressure with HEPA air filtration while work is conducted.

Specific Mitigation Measures:

The work area will be enclosed with fire resistant poly sheeting. A negative air system, equipped with HEPA filtration, will be installed to provide negative pressure in the work area. The negative air unit will be sized to provide a minimum of 4 complete air changes per hour based on the size of the enclosure. The work area will be vacuumed, using a vacuum equipped with HEPA filtration prior to the start of work and at a minimum at the end of each shift. More frequent cleaning using the HEPA vacuum will be performed if dust is present on the floors.

The new brick being installed does not contain lead. It will be cut to the proper size using a wet cut brick saw and potable water, which will minimize dust during the cutting process.

b. Blast Furnace Activities

Description of Construction:

This work entails installing a new crucible that has already been bricked in the blast furnace. The existing crucible will be relocated into the Corridor's decontamination area to remove the existing refractory brick.

This work will be completed within the total enclosure building, under negative pressure with HEPA air filtration.

Specific Mitigation Measures for Existing Crucible Refractory Removal

The existing crucible will be relocated into the Corridor's decontamination area for removal of the existing brick. The brick will be removed using wet demolition techniques, which will include pre wetting the refractory and applying a fine water mist onto the surface being demolished. The brick will be transferred into a rolloff container staged within the total enclosure building. Once the brick has been removed, the crucible will be cleaned by washing with potable water prior to storage for future refurbishment. The rolloff container will be covered when not in use and the exterior will be washed with potable water and tarped prior to removal to outside of any enclosure buildings.

c. Reverb A-Pipe Welding

Description of Construction:

Additional welding is required on the new A-Pipe to complete the structural integrity of the A-pipe.

Specific Mitigation Measures:

The areas to be welded will be cleaned by wiping with clean disposable wipes wet with a D-Lead Solution®. A wipe test will then be performed on the area to be welded using a Lead Wipe Test Kit (ESCA Tech Inc. Lead Test Kit). The test solution will be applied to the test kit supplied wipe. A wipe sample will be performed on 4 separate locations on each area to be welded using a new wipe wetted with the test solution. A yellow color

indicates lead is present and additional cleaning is required. No color change indicates no lead is present. All 4 test locations must have a negative result prior to proceeding with the welding using standard welding techniques. The MSDS for the specific welding rod to be utilized will be reviewed. A welding rod will be utilized that does not contain lead. This process will be completed for each of the 4 areas that require additional welding. The welding will be completed immediately following the wipe testing.

d. Tank/Sump Repairs Tank 12 (Santa Maria Tank)

Description of Construction:

This project entails installing new steel walls for the tank and placing grout on the foundation. .

This work will be completed within the total enclosure building which is under negative pressure with HEPA air filtration.

Specific Mitigation Measures:

The work area will be enclosed with fire resistant poly sheeting. A negative pressure air system equipped with HEPA filtration will be installed to provide negative air pressure on the enclosure. The negative air unit will be sized to provide a minimum of 4 complete air changes per hour based on the size of the enclosure.

The work area, including the floors adjacent to and around the tank and in front of the overhead door, will be vacuumed with a vacuum equipped with HEPA filtration prior to the start of work and at a minimum at the end of each shift. The north building door will remain closed except when needed to move items required for the repair that are too large to access this area by other access routes. Exide will provide an attendant to insure the large north building door is closed at all times except as described above. When use of this door is necessary, the attendant will stop the work, insure all other north facing doors are closed, open the door only enough to allow the material to be set inside the door and immediately close the door.

e. Tank/Sump Maintenance (Tank 24)

Description of Construction:

Additional fiberglass repair work is needed on the internal lining of Tank 24 (North Oxidation Tank). This tank is located outside. The work will be completed using confined space entry procedures. Confined space entry procedure includes continuous monitoring for oxygen, LEL and toxic gas and sufficient ventilation to provide a safe work environment.

Specific Mitigation Measures:

A negative pressure air system equipped with HEPA filtration will be installed to provide negative pressure on the tank. The top of the tank will be covered with a tarp that will be secured to the sides of the tank with a ratchet type strap. A small opening will be provided to allow a portion of the makeup air to enter the tank from the top. The negative pressure air system will be sized to provide a minimum of 4 complete air

changes per hour. Entry into the tank will be through a side opening. A protective clothing change area will be established at the ingress/egress into the tank. The change area will consist of a small tent placed immediately adjacent to the tank. Poly sheeting will be installed between the tank and the tent to seal off any openings and provide positive ventilation thru the change area. Personnel entering the tank will don disposable clothing prior to entry into the tank and will remove the soiled protective clothing upon exit from the tank. Multiple layers of poly sheeting will be installed on the floor of the change area. The uppermost layer will be removed and bagged for disposal once personnel have removed their soiled disposable clothing. The soiled disposal clothing and plastic sheeting will be placed into a properly labeled container for offsite disposal. No work will be conducted on this tank when sustained winds exceed 12 MPH or instantaneous winds are 20 MPH or greater.

f. Storm Water Piping Project Completion/Restoration

Description of Repairs:

Several manholes in the plant have some minor concrete repairs needed around the covers. A few inches of the new concrete will be chipped off at the covers for the repairs.

Specific Mitigation Measures:

An enclosure will be constructed around the work site. A negative pressure air system equipped with HEPA filtration will be installed to provide negative pressure on the enclosure. The negative pressure air system will be sized to provide a minimum of 4 complete air changes per hour. The concrete chipping shall be performed using a Bosch Hammer Drill with Dust Collection System Model HDC-D1. The dust shroud will be attached to a vacuum equipped with HEPA filters with a minimum of 100 CFM of air flow.

The concrete being removed will be kept damp to prevent generation of dust during the concrete chipping. This will include using a pump type sprayer or similar device to provide a fine water mist applied directly to the hammer point. The water used during the chipping shall be constantly removed using a HEPA filter equipped vacuum designed for the removal of liquids. The removed concrete shall be placed into a properly labeled container as they are removed. The containers shall remain in the enclosure and shall be covered when material is not being actively placed into the containers. All water used for chipping or other purposes shall be captured and treated properly to prevent a secondary means of fugitive emissions into the air.

All concrete or asphalt cutting/drilling performed outside total enclosure buildings shall be performed under 100% wet conditions and fully comply with the provisions of Rule 1420.1(i).

Grading of soil prior to pouring concrete or asphalt paving shall only be performed if soil surface that will be disturbed has at minimum 12% moisture content.

g. Refining Department Production Office Repairs

Description of Repairs:

Repairs are needed to the Smelting building's production office. This work is being completed in the total enclosure building that has negative air with filtration.

Specific Mitigation Measures:

This is standard indoor office repair work that does not impact any facility equipment, and has little to no fugitive emission risk. Any debris generated during the renovation will be placed into bags or wrapped with poly sheeting prior to removal from the office area. The work areas will be vacuumed prior to the start of work using vacuums equipped with HEPA filters and at a minimum once per day at the end of the shift. More frequent cleaning using the HEPA vacuum will be performed if dust is present on the floors.

h. RMPS Feed Room Sprinkler Installation

Description of Activity:

The ongoing sprinkler installation requires moving the feed piles to access the entire ceiling area. Exide will use loaders to relocate the feed stockpiles from one side of the room to the other side to provide access for the man lifts used to install the sprinkler system.

This work will be completed within the total enclosure building which is under negative pressure with air filtration.

Specific Mitigation Measures:

Normal procedures for moving the feed piles from one side of the room to the other will be followed. The loaders are already in the feed rooms and will not exit the building.

6. Other Maintenance and Specific Mitigation Measures

a. Security Surveillance Camera Installation

Description of Activity:

Security cameras need to be installed on the exterior walls of the building and on office roofs. This work entails mounting cameras by drilling small holes in walls/roofs to attach the cameras. All of the remaining locations require drilling thru steel.

Specific Mitigation Measures:

The drill used to drill the holes will be a Bosh Hammer Drill with Dust Collection System Model HDC-D1 or equivalent. The dust shroud will be attached to a vacuum equipped with HEPA filters with a minimum of 100 CFM of air flow. This high volume of air flow over this small area should provide the velocity required to remove the material removed by the drilling activities and transfer it to the drum vacuum.

b. Similar Plant and Maintenance Activities

Description of Activity:

Exide may conduct additional similar plant and maintenance activities to the extent the need for such work arises. Similar activities may include installation of replacement instruments, repair to building skin penetrations, and repairs to doors. Any such work will be coordinated with the AQMD Inspector, with reasonable advance notice. If the work is indoors, it will be completed within the total enclosure building which is under negative pressure with HEPA air filtration. Exide will also follow the General Measures described in this Mitigation Plan. To the extent specific mitigation plans are required for additional activities, Exide will work diligently to develop such plans in communication with AQMD and will submit the plans for AQMD's review and comments before beginning the work.